

SEGA®/Gremlin®

Data Bus

volume 3 number 1

a service newsletter

january/february 1982

Seven plants consolidated

SEGA/Gremlin Moves Headquarters

February marked the beginning of a long anticipated hallmark in the history of one of the industries oldest companies, consolidation of SEGA/Gremlin's seven San Diego facilities to a brand new complex in Rancho Bernardo, California.

Recounting briefly, Gremlin was founded in 1973 as the brainchild of Frank Fogleman, an electronics engineer with an extensive digital logic, computer and telecommunications background. In that year, the company began production of its first commercial entertainment device, a wall game called PLAYBALL. This game's initial success spurred an increased commitment to research and development, and led to a continuous progression of technologically advanced computer games, such as FOOSWALL, TEN PIN, and TRAP-SHOOT. By 1975, the company had expanded to the point that it had outgrown a number of facilities in San Diego, and moved into its headquarters at 8401 Aero Drive. It was there, in 1976, that Gremlin designed and introduced a self-contained business computer which offered a highly sophisticated color graphics capability with flexible general business usage. More importantly, the technology applied to the computer system offered significant opportunity for the design and development of more advanced computer video games, among them, BLOCKADE, DEPTH CHARGE and HUSTLE, introduced also in 1976. Then in 1978, Gremlin Industries was acquired by SEGA Enterprises, Inc., a corporation with over 25 years experience in the



New home for SEGA/Gremlin.

amusement industry. The added strength, imparted to the company, allowed SEGA/Gremlin to expand aggressively into the international market. A subsidiary of Gulf + Western Industries, this acquisition affiliates Gremlin with a "sister" company, SEGA-Japan Manufacturing in Tokyo. In the 4 years since the purchase, SEGA/Gremlin has been pioneering efforts in such fields as modular electronics and voice synthesis (ASTRO BLASTER), background generation (SPACE ODYSSEY & TURBO) and the revolutionary Color X-Y Monitor (SPACE FURY & ELIMINATOR). Prospects for continued growth (both economic and technical) are extremely bright. In fact, the need for physical growth was recognized over a year ago, and now after extensive planning and preparation, SEGA/Gremlin has taken its latest step, into the 123,000 square foot facility on Technology Drive, adjacent to other high-tech companies such as NCR, Hewlett-

Packard, and Sony. The consolidation of Manufacturing, Production Test, Quality Assurance and other departments promises many and varied improvements both for the employees and our customers. Drastically upgraded production potentials, expansive Q.A. "burn-in" areas, a modern Shipping & Receiving, a new master computer (the expandable Honeywell Ultimate*Level 6, 4303D), and the impressive new Pacific Telephone Dimension 100 PBX System are just a few of the items generating much excitement (and anticipation) at SEGA/Gremlin. Our new vital statistics are:

SEGA/Gremlin
16250 Technology Drive
San Diego, California 92127
(714) 485-0910
(800) 854-1938 toll-free technical assistance
(800) 854-1900 toll-free parts information
TLX 910-355-1621

tech — tips

As promised in our previous issue, we continue now with our discussion of the Color X-Y Monitor. Referring to the schematic block diagram printed in the Nov/Dec issue, the circuitry in block A serves two purposes. First, it compensates for a type of distortion known as pin-cushion distortion. This occurs because the electron-beam must travel a greater distance when striking the edges of the CRT than when it hits the center. If we cause the beam to trace along the edges of the CRT, the beam would draw a box with its left and right sides bowed inward. To compensate for the effect, this circuit off-sets the point where the beam would normally strike the CRT surface.

Secondly, this circuit contains two error amplifiers, one for the horizontal and one for the vertical inputs. Each error amp has two inputs; one is set to

zero volts, the other accepts the analog signal from the G-80, and senses current movement in the deflection coil. The analog signal is allowed to pass through the error amps and drive the deflection (power) amps. The deflection amps are shown in blocks B and F. The outputs of the X and Y power amps pass current through their respective deflection coils. Now, the output leads of the two coils are connected back to the analog inputs of the respective error amps, as mentioned above. This acts as an error, or feedback, signal and ensures that the current through the deflection coil remains proportional to the voltage on the error amp inputs. If this signal were not provided, there would be a slight deflection error when an analog input signal was present.

The outputs of the X and Y deflection amps can swing between +60

VDC and -60 VDC. This voltage is high enough to provide up to 8 amps, peak-to-peak, of current through the deflection coils.

Color drive circuits are located in schematic block C and they accept a 4 volt maximum signal on the RGB inputs. The outputs drive the three electron-beams in the CRT. Three neon glow bulbs, NE-100, 101 and 102, act as spark arrestors for the color-drive outputs to the CRT. In block D, the CRT is shown, as well as the brightness adjustment for it. The circuit of D409, R412, R411, R410 is a spot-killer that prevents the electron-beams from burning a "hole" in the phosphor surface of the CRT when the monitor is turned off. Section G of the schematic consists of the high-voltage oscillator in IC 14-2155-01 which operates the HV transformer, T901. This transformer is technically a

Zaxxon – The New Space Frontier



Zaxxon by SEGA/Gremlin.

Space games come and go, with little to distinguish one from another. Typically, you see little ships at the bottom of the display, moving laterally left and right, shooting at the descending, dancing aliens at the top of the screen. Not so, with SEGA/Gremlin's new ZAXXON. In a unique, isometric perspective, you find yourself piloting an "attack-shuttle" spacecraft, strafing the enemy's "asteroid-city" in an attempt to destroy fuel tanks, gun implacements, rockets, fighters and the dreaded enemy robot. With the aid of an altimeter that constantly monitors your height, you control your ship with an aircraft-style joystick, barnstorming your way through wall openings, under electronic barriers, dodging rockets, and in a later round, dueling with the insidious enemy robot. A successful attack-run across ZAXXON leads us to a deep-space dogfight with enemy ships. As you climb, turn and dive, a "cross-hair" appears on the screen to indicate exact positioning for a laser hit on

incoming craft. Notice the buffeting as you fly near "proximity explosions". In addition to your altitude, a running count is displayed of your score, number of ships remaining to you, number of enemy ships destroyed, and fuel remaining. Fuel bonuses are awarded for destroyed fuel tanks, but your ship crashes if you run out of fuel between rounds.

After a specified number of enemy ships are destroyed, the robot appears, launching seeker-missiles. Destruction of the robot requires six direct hits on the robot's missile launcher, after which, the round changes with greater difficulty. Number of player ships, number of enemy ships, time per round (fuel), and bonus point levels are operator selectable. Game play ends with the loss of your last ship.

Unique and beautiful graphics, combined with the challenging perspective, and fast paced game play result in another popular and profitable investment from SEGA/Gremlin.

tech — tips

flyback type, but it is not used to deflect the beam. The IC serves two other functions: It senses the presence of the 10.3 KV through R921 and R932 and compares it against the 9.1 supply voltage to ensure a regulated output. Also, this circuit senses the presence of varying current in either deflection coil. If no change is detected, the IC shuts down the high-voltage oscillator to prevent the beam from "burning" the front of the CRT.

Finally, the X-Y power supply is shown in block E; it generates the following voltages:

± 60 VDC	to X-Y power amplifiers
± 55 VDC	to RGB video drivers & spot killers
± 9.1 VDC	to ICs
+ 120 V	to flyback (EHT) oscillator

A degaussing circuit is provided through D404, D405, and R400. The CRT is automatically degaussed when R400 is cooled sufficiently to conduct current through the degaussing coil.

Having recounted briefly the "mechanics" of the monitor itself, let's go on with a further discussion of the G-80's role in all this. It's not hard to imagine how fast the input signals to the color X-Y monitor must be changing in order to produce the fantastic X-Y game displays. It's also not hard to understand that a computer must be making this happen. That is exactly the case with the G-80 hardware used in the color X-Y games. It contains two new boards, X-Y TIMING and CONTROL, that produce the X-Y monitor input signals. The G-80 still relies on its CPU, EPROM, SOUND, and SPEECH boards to complete the computer.

But what does a digital computer have to do with producing the analog signals required by the X-Y monitor? Basically, the computer converts certain digital signals into analog ones. On the G-80, X-Y boards are circuits (some of which are actually ICs) called Digital-To-Analog converters, D/A for

short. These circuits accept a particular digital word, that is, a string of 0 and +5 voltage levels. The D/A converter senses the word and outputs one and only one voltage level which corresponds to the digital word. For example, we could design a simple D/A converter that would generate the following voltages when we input certain digital words:

DIGITAL WORD	ANALOG OUTPUT
0000	-1 VOLT
1111	+1 VOLT
1000	0 VOLT

This is a very basic case, but it shows that, for a particular D/A converter, we always produce one voltage level from the corresponding digital input. If we cycle through a variety of digital inputs, we'll get a variety of output voltages. If we do this fast enough, we actually create a rapidly varying range of voltages. This output is exactly the kind of signal we need to drive the deflection coils in the monitor.

Now we know where the analog signals come from. What about the digital ones? What is their role in the X-Y system? Here's what happens:

Before we can display anything on our X-Y screen, we have to ask some questions: (Answers are provided for example's sake)

1. What do you want on the screen?
A triangle
2. How many?
Just one
3. What design, what angles?
Equilateral
4. Dimensions?
3" on a side
5. Positioning?
Dead center on the screen
6. What colors?
2 sides white, one blue
7. Representation?
Like this:

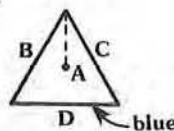

8. Will it move?

No

9. How many lines does the electron-beam have to make to create the design?

4 lines, A (even though we won't see it), B, C and D.

Now that we have all our specifications, we have to store this information someplace so the Timing and Control boards can get to it and understand it. That place is video memory RAM. It holds 4096 8-bit words or bytes. Of course, we don't stick all this into video memory and hope the X-Y boards find it. We store the information in an orderly fashion.

First, we divide the video memory into two main groups—let's call them 1) The Symbol Instructions, and 2) The Line Instructions. Into the first section we store one group of ten words for every symbol or design we put on the screen. In our example, we have only one symbol, so we use only 10 words. Into the Line Instructions section, we put one group of four words for every *Line* that the beam has to draw. So, for our triangle, which requires 4 lines, we would store 4 groups of 4 words in the Line Instructions space. Every word we store in memory has one and only one address, so the same word can be called on over and over. In the next issue of DATABUS, we'll look closer at Symbol Instructions Memory, Line Instructions Memory, & conclude our series on The Color X-Y Monitor with a G 80 logic overview. Now, let's look closer at the Symbol Instructions memory space. Here is what the 10 words do: (Don't be concerned with actual values of those words right now.)

Word 1

It tells the X-Y boards either to make the beam draw the symbol in this group of words or not to draw it. And, the same word informs the boards that either this group of words is the only group or

4 – Data Bus

tech — tips

Words 2 and 3 that there are more 10-word groups or follow. These tell the boards where the beam is on the X-axis.

Words 4 and 5 These tell the boards where the beam is on the Y-axis. The last four words, then, give the exact coordinates of the electron-beam.

Words 6 and 7 Words 6 and 7 tell the X-Y hardware what the first address is of the Line Instructions section.

Words 8 and 9 These tell the hardware how the complete symbol (our triangle) will appear on the screen, or at what angle.

Word 10 This word tells what the overall size of the design will be.

Again, since we're only making one design, there will be no more 10-word groups after the one above. Now, take a look at the Line Instructions section of memory:

Word 1 This word tells the G-80 boards either to blank (stop) or to unblank (start) the line. And it informs the boards that either additional 4-word groups follow or no more groups follow. Finally, it defines the color this particular line is to be.

Word 2 This word represents the length of the line the beam is to draw.

Word 3 Word 3 tells the hardware at what angle the beam should make its line. 45 degrees? 90 degrees?

Word 4 Word 4 defines in which of the four sections of the screen the line is to appear—which quadrant.

The remaining 4-word groups contain the same representations of their respective lines, as in Group 1. The values will be different, of course, depending on how the lines differ. In our triangle example we find 3 more groups of four words after Group 1.

By now, you may be wondering what all these "words" really are. Since we are dealing with a digital computer, the "words" we described above must be digital. More accurately, they are digital values of the specifications for sizes, angles, shapes, colors and locations converted into digital formats that the G-80 system understands. Then we let the G-80 read these words and create displays that the words represent.

Continued next issue.

COLOR X-Y MONITOR MODEL G08-003

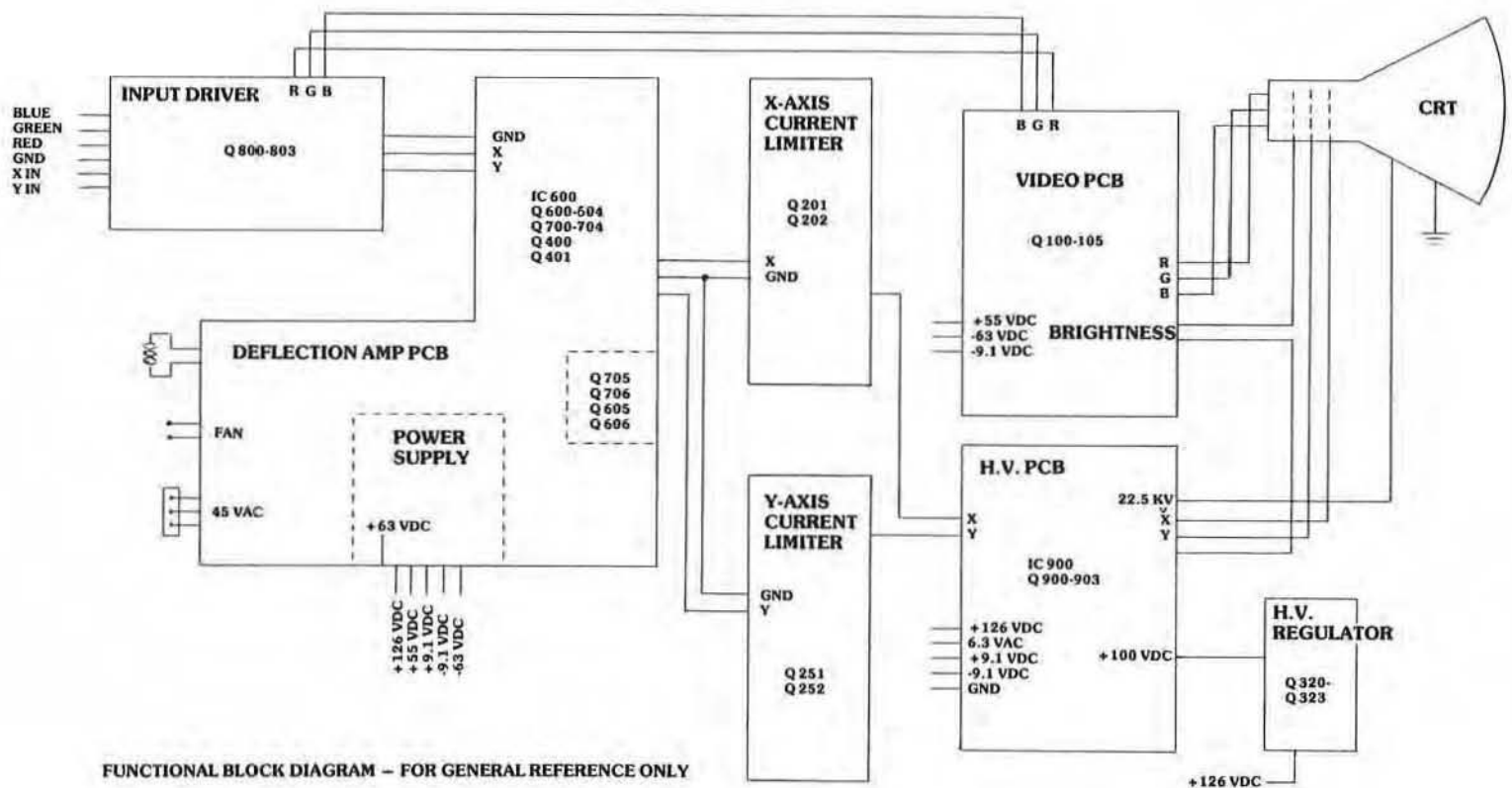

FUNCTIONAL BLOCK DIAGRAM – FOR GENERAL REFERENCE ONLY

service notes

TURBO

It has been noted that some TURBO units are experiencing small white vertical lines on the monitor. The problem was traced to the 5 MHz clock pattern impedance, and is corrected on the CPU Board (P/N 834-0110) as follows:

- On page 136 of the TURBO Owner's Manual (P/N 420-0681), sheet no. 1, zone 7C, correct pin 26 IORE to read, pin 20 IORE.
- In zone 7B on the schematics, and on the board itself, add the 820 ohm resistor (P/N 470-0821) provided in the rework kit between pin 2 and pin 16 of IC 65.
- On page 137 of the Owner's Manual, sheet no. 2, zone 4B of the schematics, and on the hardware, add the 330 ohm resistor (P/N 470-0331) between pin 7 and pin 8 of IC 110.
- On page 140 of the Manual, sheet no. 5, zone 3B, add the 0.1uf ceramic capacitor (P/N 151-0024) between pin 8 and pin 9 of IC 95, and IC 96.
- On page 105 of the Manual, please add these items to the CPU Board Parts List as follows:

ITEM NO.	PART NO.	QTY. REQ'D	DESCRIPTION
189	470-0331	1	820 ohm resistor
190	470-0821	1	330 ohm resistor
191	151-0024	2	0.1uf ceramic capacitor

An error has been found in the TURBO Owner's Manual (P/N 420-0681), please correct your documentation to reflect the following:

- On page 135, in the extreme upper left-hand corner, delete;

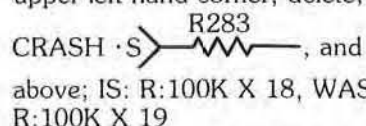

- On page 131, at the top of the page, delete;

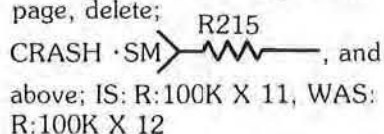

- On the Sound Board itself (P/N 834-0123), remove R215 and R283 physically from the board.

ELIMINATOR

An error was found on page 46 of the Owners Manual (P/N 420-0603), the A.C. Junction Box Assy. Item 8 should read:

ITEM NO.	PART NO.	QTY. REQ'D	DESCRIPTION
8	514-0053	1	5 amp fuse, 250 V. Slow-Blow

It is possible that some ELIMINATOR games may have left the factory with fast-blow fuses in the "J-Box". These should be replaced with a slow-blow fuse, as above.

Also, 220 VAC installations (i.e. Europe) in addition to an input transformer strapping modification (input AC to pins 1 and 4), must change down to a 3 amp fuse, 250 V, Slow-Blow (P/N 514-0011).

VIDEO I BOARD

An error has been found on the VIDEO I BOARD schematic, Drawing

No. 800-0106. Please correct your documentation to reflect the following:

SHT #6

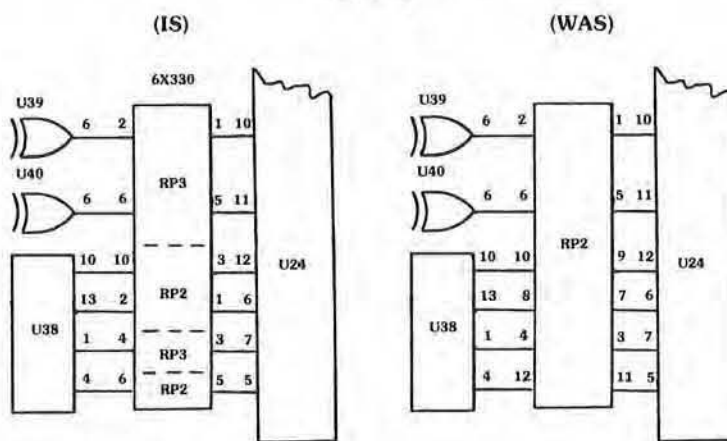

SHT #7, ZONE A7

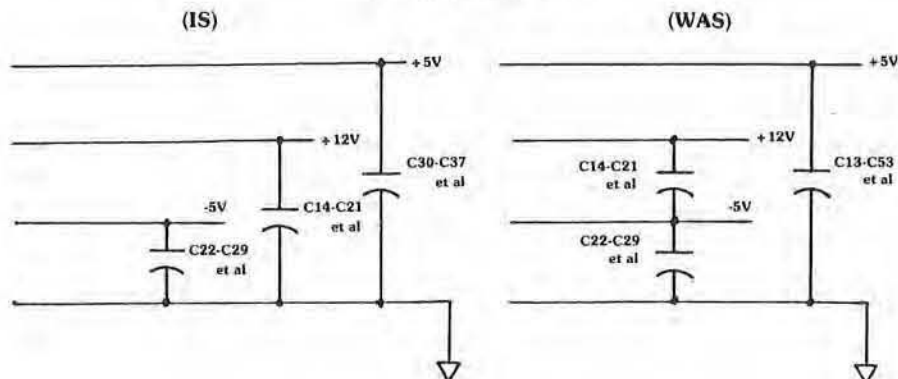

This Service Note applies to ASTRO-BLASTER, SPACE ODYSSEY, and 005. (i.e. all raster-scan G-80 games).

continued on page 7

the ROM line

Due to the number of requests we've received since the last issue, our discussion of microprocessors will begin in the March/April issue; here we will continue our review of TTL, and to all those who wrote in, thanks again, we really DO appreciate the input.

7404 HEX INVERTER:

Figure 1 illustrates an integrated circuit containing six simple inverter circuits. Each circuit functions simply to invert the state of the voltage applied to its input. If the input is LOW, the output will be HIGH. Conversely, if the input changes to a HIGH state, the output will immediately change to a LOW state. Thus, it "inverts" the signal applied to the input terminal. Inverters are used primarily to invert a signal that is of the wrong polarity to interface with, or drive, another circuit or device.

7404 HEX INVERTER

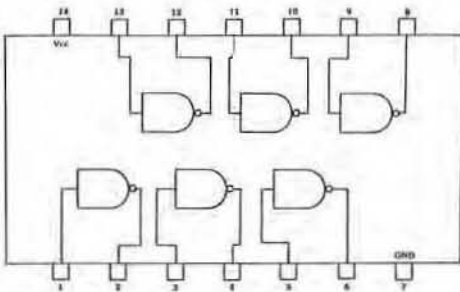

Figure 1

7408 AND GATE:

Figure 2 depicts a Quadruple 2-input AND gate, the 7408. In operation, the output of each gate will go HIGH only if *both* inputs are HIGH. Restated, the output will change to a HIGH state only when both input 1 AND input 2 are HIGH. It is therefore called an AND gate.

Consider a typical application: If input 1 remains at a LOW state, the output will be LOW and any changes at the other input will not affect the output. However, if input 1 then goes

HIGH, it will allow the changes at the other input to appear at the output. Returning input 1 to the LOW state will again cause the output to go to the LOW state and inhibit any further signals at input 2 from being felt at the output. Thus, the signal at input 2 has been "gated" to the output by a signal applied at input 1. Hence the term GATE.

7408 QUAD 2-INPUT AND GATE

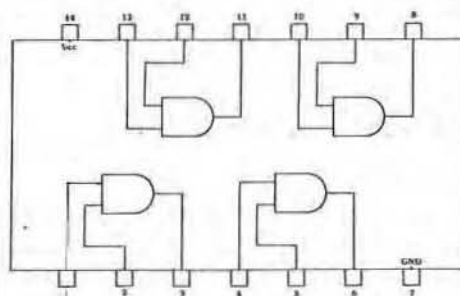

Figure 2

7474 "D" FLIP-FLOP:

The circuit shown in Figure 3 is a Dual D-Type, Edge-Triggered Flip-Flop. It is a relatively complex circuit made up of several of the gates discussed above. It is conventionally shown as a "block" diagram with input and output functions designated as shown, and it operates as follows:

Input information is applied at the "D" input. This may be either a HIGH or LOW potential. The input is transferred to the Q output upon the positive transition of a pulse applied to the clock (CK) input. For instance, if a HIGH is applied to the "D" input, and held there, no change in the Q output will be noted until a clock pulse is applied to the CK input. When the positive edge of the clock pulse occurs, the HIGH felt at the input will be transferred to the Q output. Any additional clock pulses that occur while the "D" input remains HIGH will cause no further change. However, should the "D" input go to a LOW state, the positive transition of the next clock pulse will cause the Q output to

go LOW.

The "D" Flip-Flop also has a Q (pronounced "Q-Bar") output, which simply provides an output that is always the opposite of the Q output. If Q is HIGH, Q will always be LOW, and vice-versa.

Input information is applied at the "D" input. This may be either a HIGH or LOW potential. The input is transferred to the Q output upon the positive transition of a pulse applied to the clock (CK) input. For instance, if a HIGH is applied to the "D" input, and held there, no change in the Q output will be noted until a clock pulse is applied to the CK input. When the positive edge of the clock pulse occurs, the HIGH felt at the input will be transferred to the Q output. Any additional clock pulses that occur while the "D" input remains HIGH will cause no further change. However, should the "D" input go to a LOW state, the positive transition of the next clock pulse will cause the Q output to go LOW.

A "D" Flip-Flop also has two other inputs labeled "PRESET" and "CLEAR". These inputs may be used to set the outputs to a desired state. With both the PRESET and CLEAR inputs held HIGH, the circuit will operate normally. If a LOW is applied to the PRESET input, it will cause the Q output to go LOW. Conversely, if a LOW is applied to the CLEAR input, it will cause the Q output to go HIGH. It is important to note that a LOW input to either the PRESET or CLEAR will override any other input functions.

It should also be noted that clock triggering occurs on the positive-going transition of the clock pulse, thus, the 7474 is called an "edge-triggering" Flip-Flop. Triggering occurs at a voltage level of the clock pulse and is not directly related to the transition time of the positive-going pulse. After the clock input threshold voltage has been passed, the data input "D" is locked out, and any change in the "D" input after that time will not affect the outputs until the next positive-going

the ROM line

transition of the clock pulse.

7474 DUAL D-TYPE EDGE-TRIGGERED FLIP-FLOP

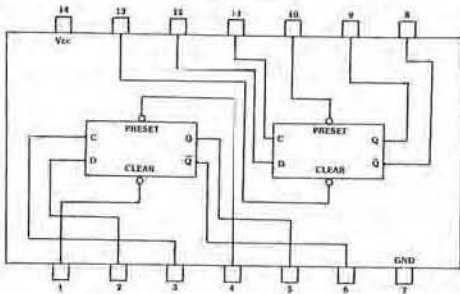

Figure 3

7490 DECADE COUNTER:

Figure 4 illustrates a 7490 decade counter which is a circuit composed of several internally connected Flip-Flop circuits. They are connected in a manner that allows division of the input signal frequency by a factor of 10. In addition, the state of the count is provided at four digital output pins, which are the outputs of the four internal flip-flop circuits.

Figure 4a shows the output configuration of those four output pins as the number of input pulses applied goes from one to ten. These four out-

puts provide "Binary-Coded Decimal" (BCD) information which may be decoded by additional circuits for display as numbers or sequential events.

The 7490 counter has gated direct reset lines which inhibit all count inputs and returns all outputs to a LOW (Logical 0) state (Pins 1 & 2 on the IC). Additional reset lines are provided at pins 6 & 7 which will preset the counter to a BCD 9 count for certain applications. With both reset circuits (Pins 1, 2, 6, and 7) held LOW, the counter will count normally.

7490 DECADE COUNTER

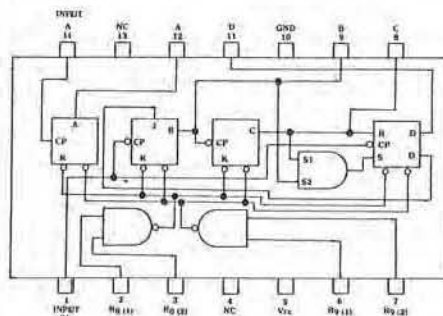

Figure 4

BCD COUNT SEQUENCE (See Note 1)

COUNT	OUTPUT			
	D	C	B	A
0	0	0	0	0
1	0	0	0	0
2	0	0	1	0
3	0	0	1	1
4	0	1	0	0
5	0	1	0	1
6	0	1	1	0
7	0	1	1	1
8	1	0	0	0
9	1	0	0	1

RESET/COUNT (See Note 2)

RESET INPUTS				OUTPUT			
R0(1)	R0(2)	R9(1)	R9(2)	D	C	B	A
1	1	0	X	0	0	0	0
1	1	X	0	0	0	0	0
X	X	1	1	1	0	0	1
X	0	X	0	COUNT			
0	X	0	X	COUNT			
0	X	X	0	COUNT			
X	0	0	X	COUNT			

NOTES:

- Output A connected to input BD for BCD count.
- X indicates that either a logic 1 or a logic 2 may be present.
- Fanout from output A to input BD and to 10 additional Series 54/74 loads is permitted

continued from page 5

service notes

FOUR-PLAYER ELIMINATOR

An error has been found in the FOUR-PLAYER ELIMINATOR Owner's Manual (P/N 420-0705), page 72, Top Assembly Drawing No. 700-0071, Zone 6-D. Please correct your schematic as indicated:

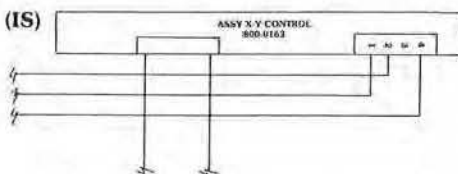

X-Y TIMING BOARD

In order to eliminate occasional extraneous vectors from the right edge

of the Color X-Y Monitor display, please make the following corrections to your Owners Manual (P/N 420-0605), and the X-Y Timing Board:

1. add to the Parts List:

ITEM NO.	PART NO.	QTY REQD.	DESCRIP.	REF DES.
40	151-0002	2	CAP CER	C32,C33 100pf 50V

- on page 40, sheet 5, zone D4 & B4 of your Owners Manual, add the capacitors to the schematic as shown below, and;
- install C32 between pin-2 & pin-6 of U2
install C33 between pin-2 & pin-6 of U3

To ensure that the vertical and horizontal outputs of the G-80 X-Y Timing Board do not exceed a preset level, the addition of 2 diodes is recommended. The diodes, type 1N914, are installed as follows:

- Remove the G-80 Timing Board from the card cage.
- Solder the ANODE of one diode to Pin 1 of the Molex connector located on the front edge of the Timing Board. It is recommended that the diode be installed on the underside of the board.
- Solder the CATHODE of the diode to a +5 volt pad on the back of the board. This can be found at the +5 volt pin on the closest IC.

continued on page 8

input port

Continuing our question and answer column, we would like to thank you for your interest and urge you to "keep those cards and letters coming." We do answer technical questions in this column, both written and those called in. If writing, please direct your questions to:

Editor — Data Bus
SEGA/Gremlin Customer Service
16250 Technology Drive
San Diego, CA 92127

Q: My ELIMINATOR freezes up from time to time. The Reset button works for a while, and then freezes again. What do I do?—J. Easily, Portland, Oregon

A: Occasionally, multiplier problems (gate racing) resulting in a frozen display can be alleviated by modifying the X-Y Timing Board as follows: PCB #170-0218, 800-0106 Assy, Rev. A

1. cut pin-1 of U14 as close to the PC Board as possible and lift the pin away from the board.
2. install a 2.25" jumper wire (AWG 30, 28, or 26) from pin-5 of U23 to pin-1 of U14 (on leg of the IC).

Q: The sound out of my TURBO is pretty noisy. Is there a fix for this?—F. Thomas, Hoboken, New Jersey.

A: Yes. Simply remove R215 and R283 from the Sound Board (P/N

800-0123).

Q: Upon receiving a TURBO from your factory distributor here, I found that during the self-test program, the accelerator test shows only 0,1,2. How do I adjust that?—B. Morely, Denver, Colorado.

A: Some TURBO units do not provide full accelerator control. Recently, all of our distributors have been given a simple rework kit to take care of that very problem. Your distributor will forward the kit to you soon, but in the meantime, this is the procedure:

1. On the Accelerator Mechanism IC Buffer Board (P/N 834-0104), located on the mechanism itself, exchange the two 10K ohm resistors for the two 22K ohm items provided in the rework kit. Re-run the self-test sequence.
2. If the problem persists, adjust the power supply voltage to 4.8 VDC at full load, or 5.1 VDC at no load.

Q: The "GAME TIME" setting of my TURBO doesn't change. Is the DIP switch bad, or is something else wrong?—E. Lessing, Los Angeles, CA.

A: On page 5 of the TURBO Owner's Manual (P/N 420-0681) we suggest that you add the following notes:

1. When the CPU Board DIP Switch #1 is set in the "SKILLED" position, game time is automatically set to 55 seconds. Option switch settings have no effect.
2. Regardless of "GAME TIME" option selection, the displayed countdown begins at 99 seconds, but does vary its rate of countdown according to option selection settings of DIP Switch #2 position 1 & 2.
3. DIP Switch #1 position 5 is an option used for game testing purposes. Set in the "OFF" position, the game will operate normally. Set in the "ON" position however, your car will not crash. In other words, DIP Switch #1 position 5 is an "endless game" option.

Q: My arcade is pretty loud, with all the game sounds and people. I need full volume from all my games, but my TURBO keeps blowing the fuse when its turned up all the way. Can I modify it?—E. Constantine, Detroit, MI

A: Yes. Your distributor will be sending you a package of resistors; the 220 ohm 1/4W resistor is added to pin-1 of each volume control pot, and the 3.3K 1/4W resistor is added in series to pin-3 of each volume control pot. This will solve your problem.

continued from page 7

service notes

4. Install the CATHODE of the second diode to +5, in the same way. Then, solder the ANODE of this diode to Pin 4 of the Molex connector.

Data Bus is a service newsletter published by SEGA/Gremlin Customer Service, 16250 Technology Drive, San Diego, California 92127

Editor — Richard Cortez
Writer — Jim Bender
Photographer — Ron Stein
Layout — Carol Johnson

Parts Order — (800) 854-1900
Technical Assistance —
(800) 854-1938
TLX — 910-355-1621