

11  
CE

**WURLITZER**

**RAVE ON**

184/F91



**OPERATING INSTRUCTIONS**

# Table of contents

---

## Unpacking

Unlocking  
Removal of shipping guards

## Loading compact discs

Power on  
Position of the CDs in the magazine  
Remove magazine  
Inserting CDs  
CD handling precautions  
Insertion of CD covers and title cards  
Programming number of CDs in the magazine  
Exit the service program

## Coin operation or free play ?

Coin operation  
Free play  
Test credit

## Track selection

How to select a track  
The button R (Reset)  
The display flashes  
I do not like this track - The button CANCEL  
Albumplay - playing the whole CD

## Volume, sound and balance control - F91

The control terminal at the rear side  
The meanings of the buttons  
The infrared remote control  
Pre-settings for volume  
Pre-settings for bass and treble

# Table of contents

---

## Volume, sound and balance control - I84

- Volume control
- Treble and bass control
- Slide switch "Stereo/2-Kanal"
- Automatic loudness controller
- Infrared remote control with selection buttons
- The meanings of the buttons

## The internal clock

- Clock setting
- Set date
- Set year and weekday

## Automatic random select (Playstimulator)

- Repeat time programming
- Programming start and stop time

## Back Ground Music

- Number of BGM CDs and BGM repeat time
- Start position of Back Ground Music CDs and configuration
- BGM time zones at different weekdays

## Further options

- Number of tracks played successivly from the same disc
- Selective disabling of tracks
- Selection and credit memory reset by power off

## Cleaning possibilities (CDs and CD player)

- Nikotine, dust, fingerprints
- Removing scratches
- Laser lens cleaning

## **Table of contents**

---

Technical data

Declaration of conformity

Index

---

## **Warning**

Although the beam emitted by the laser diodes is nearly invisible, it may cause several damages to the human eyes. When the laser is being operated, the emitting surface must not be viewed either directly or through a lens, fiber or mirror.



## **Caution**

The CD mechanism and many electronic components are extremely susceptible to electrostatic discharges.

Careless handling may immediately destroy components or can drastically reduce life expectancy of these components so that it will lead to failure after several weeks or even months of use.

Before you touch the player, discharge your hands and tools by touching a grounded metal part of the jukebox, such as the amplifier or the mechanic chassis. Do not touch terminals or electronic components.



# Unpacking

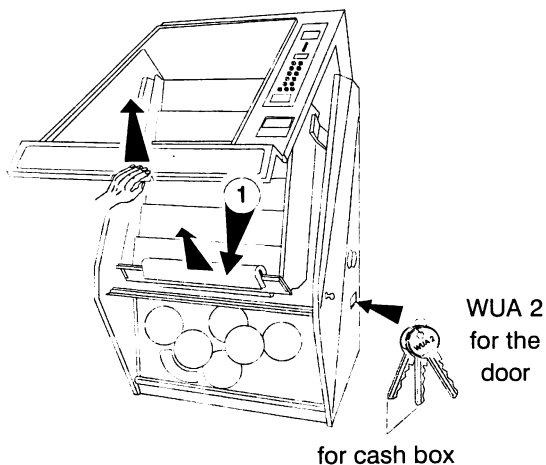

## Unlocking

The key is stored in the coin return cup in the RH cabinet wall. The key WUA 2 unlocks the cabinet by turning the key clockwise. The lock is spring loaded, press slightly against the door, this allows to turn the key easily. The two other keys with 5 digit number codes unlock the cash box at the bottom inside the cabinet. In this box the hand transmitter is located if an infrared remote control had been installed.

## Removal of shipping guards

1. Open the door and remove the foam from the prism book.
2. Remove elastic band from the magazine cabinet and remove the plastic pane completely.
3. Remove CD lens cover.
4. Take out the magazine and loosen both wing nuts on the bottom of the magazine cabinet until fully extended.

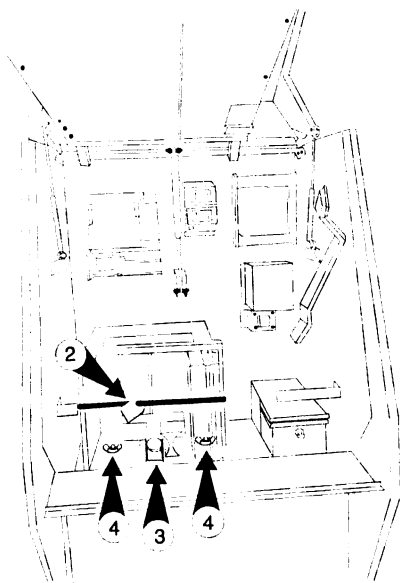

### IMPORTANT:

Save the removed shipping guards. You may need them if you decide to move your machine to another location.

## Loading compact discs

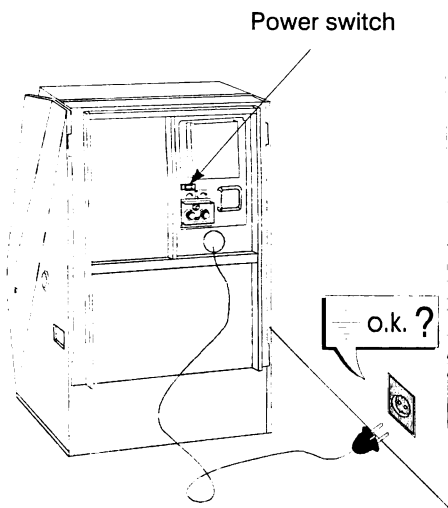

### Power on

#### **IMPORTANT!**

**Make sure that wall socket is grounded properly.**

Insert the power plug. Set the power switch on the rear side of the jukebox to ON. The illumination will light. The selection sledge starts an initialisation run and the counting of the disc compartments can be watched in the display. If all compartments are recognized the display shows "0 0 6 1" for short time. After all the sledge stops in its home position. The digital display shows the most played track, the 'Hit Of The House'. If the box is brandnew and the selection memory is empty the display shows "0 0 0 0".

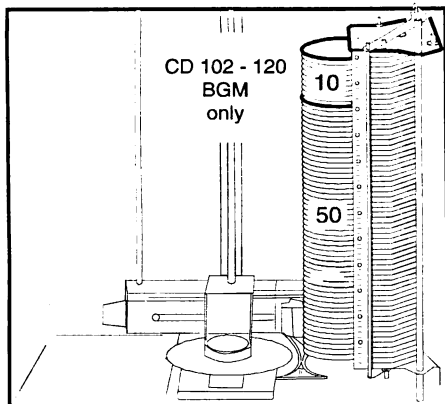

### Position of CDs in the magazine

The magazine only contains all CDs with even selection numbers (e.g. 02, 04, 06 ...). So you can insert a maximum of 60 CDs. But only 50 CDs can be selected in normal operation, the even selections between CD no. 00 and CD no. 98. CD no. 00 corresponds to compartment 100. The CDs with the (even)numbers between 102 and 120 can only be used for Back Ground Music.

## Loading compact discs

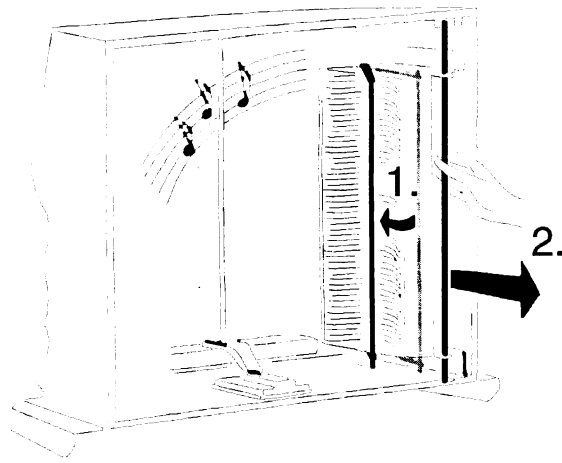

### Remove magazine

You can put out the magazine by turning the latch bar (1). At the same time possibly in the magazine located CDs are saved. Pull the handle bar (2) to remove the magazine completely. When you insert the magazine later again the latch bar clicks into place. This will fix it firmly.

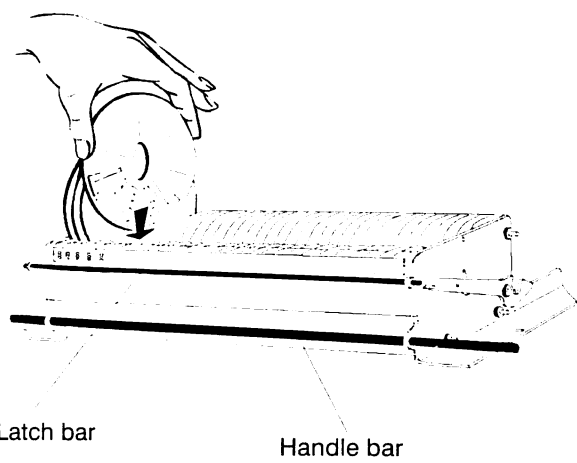

### Inserting CDs

You can lay the magazine flat on a surface. Insert the CDs starting in compartment 02. The CD label has to show to the higher compartment numbers.

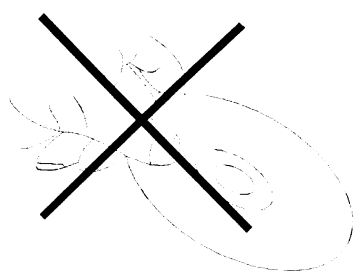

### CD handling precautions

Dust, fingerprints or other dirt on the disc surface can cause skipping, jumping or sticking problems. Use only clean and undamaged CDs. Never touch the surface of a disc.



# Loading compact discs

## Insertion of CD covers and title cards

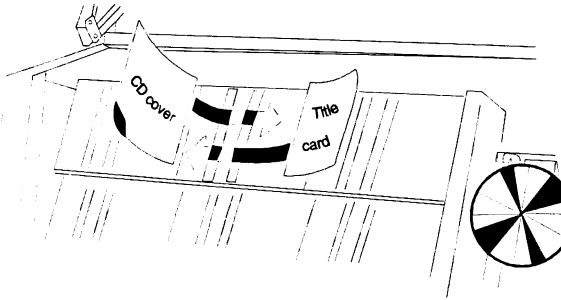

It is recommended to insert the Compact Disc and then the title page into the appropriate numerical slot position of the prism page system.

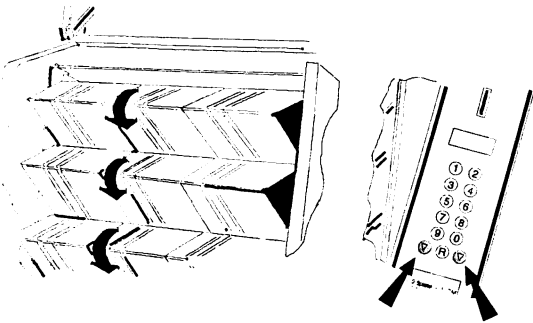

Buttons to turn the prisms

You can turn the prisms by pressing one of the both arrow buttons. They will stop automatically in the next position.

To avoid that the changer mechanism operates with empty compartments, if less than 50 CDs are inserted the corresponding number of CDs has to be reprogrammed.

If the number of CDs is correct programmed the display will flash when you select an empty compartment. A flashing display always indicates a wrong (also an odd) selection or not enough credit.

The number of CDs in the magazine has to be programmed in service level 1, selection button 5, described as follows.

# Loading compact discs

## Programming number of CDs in the magazine

The CD mechanism of the Rave On only contains the RH magazine. Therefore only the even selection numbers can be used. All the odd selections will be skipped. Because of this the double number of the really (max. 100) inserted CDs has to be programmed.

At the rear wall inside of the jukebox cabinet the so-called Selection & Credit Computer is situated. Some units are equipped with a metal cover. But the slide switch "SERVICE" and the button "LT" are accessible through holes.

To program the number of inserted CDs (service level 1):

1. Set the slide switch 'SERVICE' at the SCC-unit to ON.
2. Press 'LT' button.
3. Press selection button R -hold down- and press selection button 0 than release both buttons.
4. Press selection button 1. Service level 1 is reached. Display is: 1 \_ \_ \_.
5. To reprogram press selection button 5 -hold down- and press selection button R. Enter the double number of inserted CDs with two digits (exception: 100. CDs = 00).  
Example: 24 CDs really exist - enter 48.

To check the new settings, press button 5 again.

## Exit the service program:

1. Set the slide switch 'SERVICE' at the SCC unit to OFF.
2. Press 'LT' button.

The changer starts an initialisation run. After this the jukebox is ready to operate.

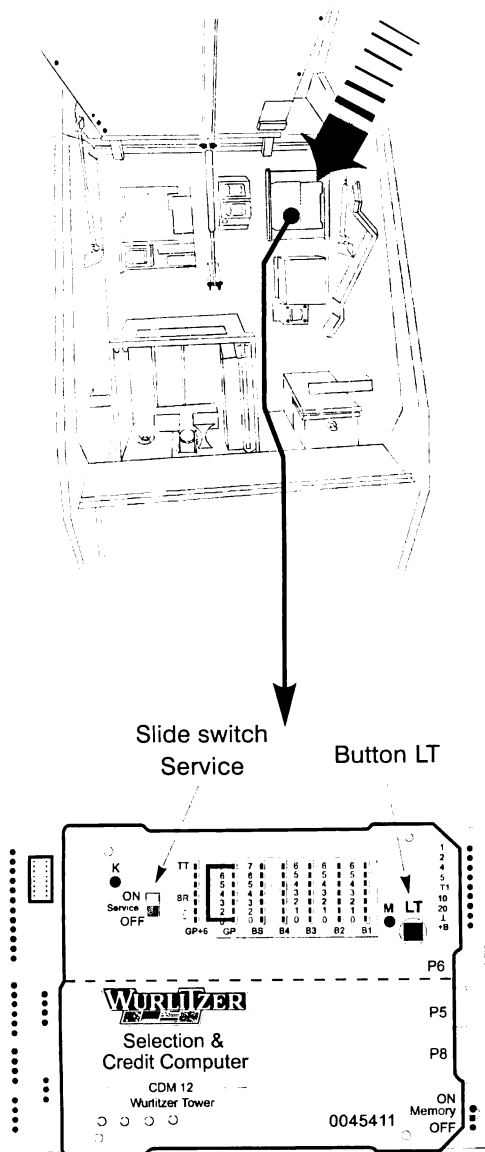

# Coin operation or free play ?

jumper from 0 to F  
in row GP

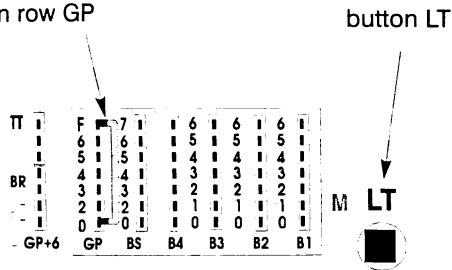

Both coin operation or free play are adjustable at the "Selection & Credit Computer" unit. It is located at the RH side of the rear wall inside the cabinet underneath the changer mechanism housing. Special jumpers (short wires, located in the accessory pack of the manual) are used to be set on the SCC-unit. The cover (if it exists) has to be removed. As long as no jumper is set in row GP from 0 to F (free play) the jukebox works with coins only.

## Coin operation

From factory the jukebox is set to coin operation. If you insert a certain number of coins according to the denomination label, the jukebox gives the credits or plays it is adjusted for. If you want to change the play prices you have to change the jumper settings on the SCC-unit.

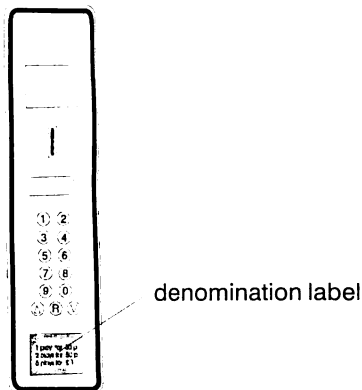

## Free play

To set the jukebox to free play:

1. Set a jumper from 0 to F (free play) in the row GP on the SCC unit.
2. Press 'LT' button.
3. Now **one track** is selectable without coin insertion.
4. In between two to six plays are selectable by setting an additionally jumper in the row 'BS' (Bonus Step) from 0 to 2 or from 0 to 6.
5. Up to **47 tracks** are pre-selectable by setting a jumper in the row 'BS' from 0 to 7.

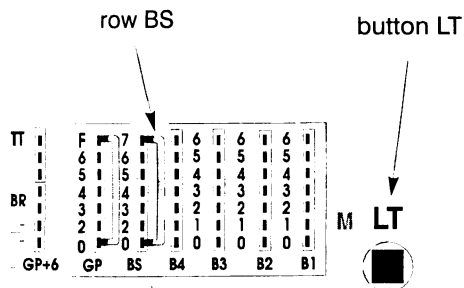

You have to remove possibly earlier inserted jumpers in the rows GP and BS. Notice its position for a resetting to coin operation in future.

## Coin operation or free play ?

---

### Test credit

*For repair and test purposes it is possible to give test credits. By touching the test credit button you get one credit also shown in the digital display. You can terminate not needed credits by pressing the LT button.*

In jukeboxes with an electronic coin validator you can find the test credit button on the coin validator interface board.

In jukeboxes with mechanical coin validator the test credit button is mounted over the return lever inside.

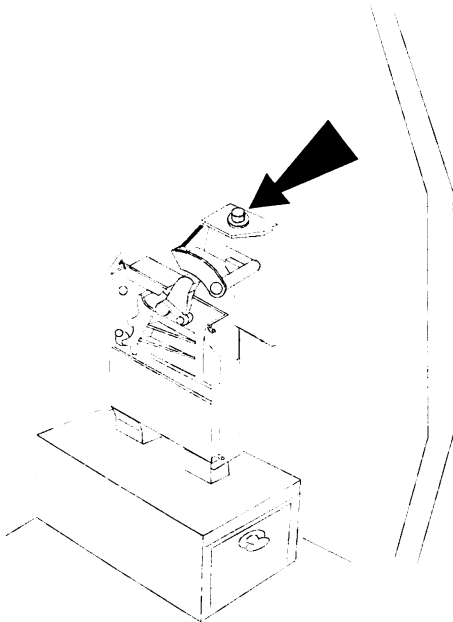
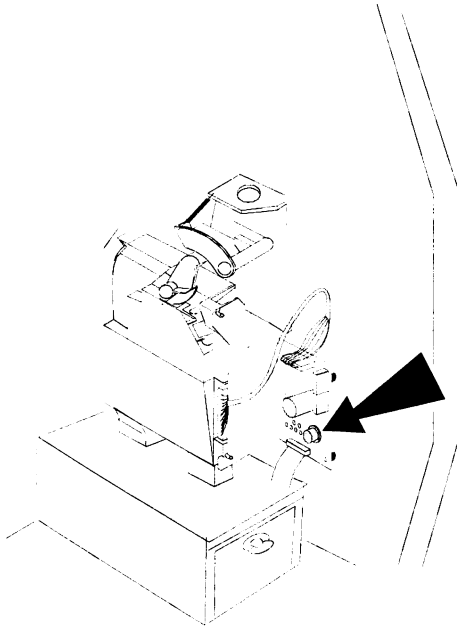

# Track selection

---

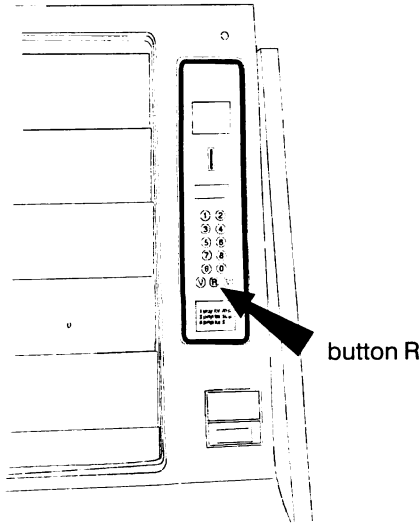

## How to select a track

If credit exists or free play is set you can select tracks by means of the buttons 0 - 9 of the keyboard.

First enter the number of the CD with two digits, then the track with two digits too. Remember that the Rave On only accepts even selection (CD) numbers.

Example: CD 2, track 9: Enter 0 - 2 - 0 - 9.

(Exception: CD 100 = 00.)

## The button R

You can delete wrong entered numbers up to the third digit by means of the button R (Reset). But after having entered the fourth digit the jukebox stores and executes a selection also made by mistake. By pressing the button R the available credit will be displayed for a few seconds.

## The display flashes

After entering the fourth digit of a selection the jukebox starts to search and play the selected CD immediately. If the display flashes the entered selection was not valid. Check:

- if credit is available or
- if the selection is higher then the programmed number of CDs in magazines or
- if you have selected an odd selection number



If you select a higher track number as available on a CD the jukebox overcounts the tracks and starts at the beginning. Example:

CD 06 contains 17 tracks. But selected track is 0 - 6 - 1 - 9.

The jukebox plays track 02 of CD 06.

# Track selection

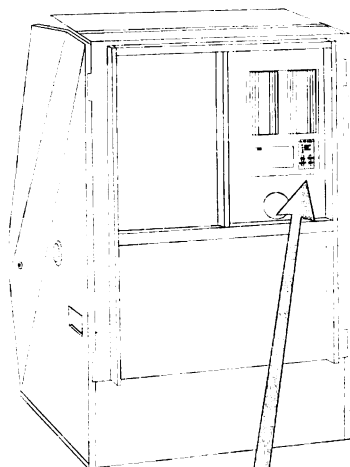

Control terminal  
F91

WURLITZER

⊛ VOLUME  
⊙ BASS  
⊙ TREBLE  
⊙ BALANCE  
- +

MODE PRESET

CANCEL MUTE

button  
"Cancel"

Control terminal  
I84

button  
"Cancel"

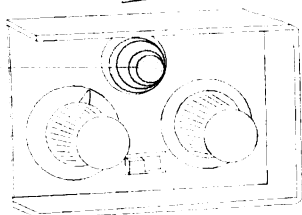

## I do not like this track - The button CANCEL

If you do not like a track you can cancel it by pressing the button 'CANCEL' at the rear side of the jukebox or at the remote control. The jukebox stops playing or plays the next track if a selection has already been made.

You can terminate all selections only by pressing the button LT on the SCC unit .

## Albumplay - playing a whole CD

You can select a whole CD by entering the CD number followed by two times 0. Condition is that 'Albumplay' is enabled and the SCC has either reached the fourth bonus level or free play is set.

To enable 'Albumplay' (service level 1):

1. Set the slide switch 'SERVICE' at the SCC-unit to ON.
2. Press 'LT' button.
3. Press selection button R -hold down- and press selection button 0 then release both buttons.
4. Press selection button 1. Service level 1 is reached. Display is: 1\_ \_ \_.

Then press selection button 9 -hold down- and press selection button R. Release both buttons. Enter 01 to enable (or 00 to disable) 'Albumplay'. To check, press selection button 9 again.

## Exit the service program:

1. Set the slide switch 'SERVICE' at the SCC unit to OFF.
  2. Press 'LT' button.
- The changer starts an initialisation run. After this the jukebox is ready to operate.

# Volume, sound and balance control - amplifier F91

## IMPORTANT !

Depending on the adjusted volume of the jukebox loudness levels of more than 70 dB can be reached.

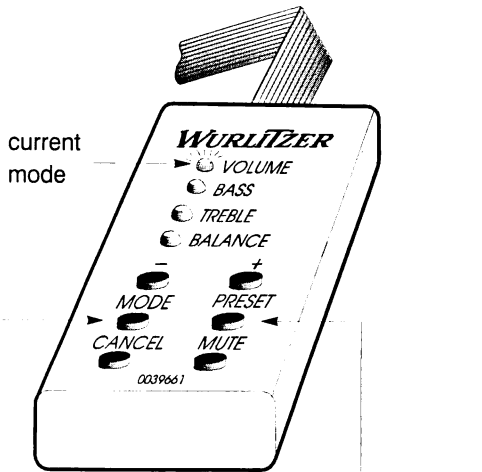

**+/- VOLUME** — LED Volume lights

Press MODE button once

**+/- BASS** — LED Bass lights

Press MODE button once

**+/- TREBLE** — LED Treble lights

Press MODE button once

**+/- BALANCE** — LED Balance lights

Press MODE button once

## The control terminal at the rear side

With the control terminal at the rear side of the jukebox the volume, treble, bass and balance can be controlled individually.

After power up or if no button has been pressed for approx. 5 sec or after the button PRESET has been pressed, the terminal stays in the mode "VOLUME". The LED "VOLUME" lights. In this mode you can control the volume by means of the buttons '+' and '-'.

One LED corresponds to each mode. All reachable by pressing the 'MODE' button. With the buttons '+' and '-' treble, bass or balance can be controlled.

The control terminal can be taken out and be used as a wired remote control.

## The meanings of the buttons...

- **MODE:**  
Switches to the next operating mode. After about 5 seconds without operating any buttons, 'VOLUME' mode is resumed.
- **PRESET:**  
Volume, bass, treble, and balance are set to the pre-set according to DIP switch setting. Actual mode is set to 'Volume'.
- **CANCEL:**  
Rejects a playing track. If album play is selected the next track will be played.
- **MUTE:**  
As long as this button is activated, the amplifier output is muted.

# Volume, sound and balance control - amplifier F91

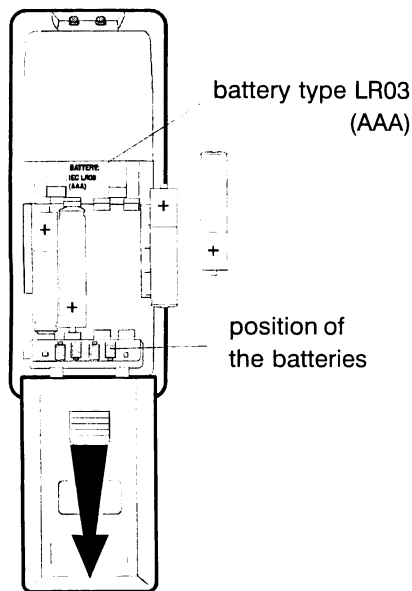
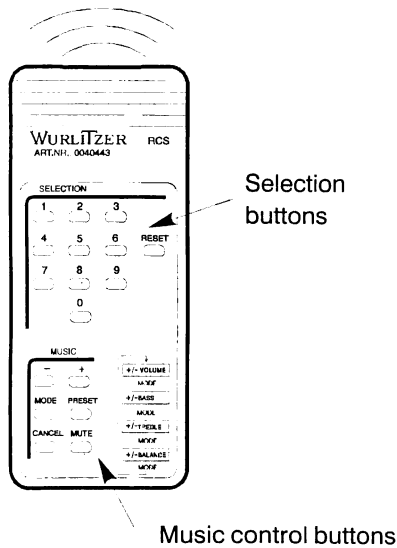

## The infrared remote control

As desired an infrared remote control will be installed from factory or can be delivered as conversion kit (part no. 40435). If it has been installed the hand transmitter is located in the cashbox.

If credit is given or free play is programmed a CD can be selected with the buttons 0 to 9 and R.

*Double button functions as required in the service programs (i.e. press button 5 -hold down- and press button R), are impossible. For this you only can use the keyboard of the jukebox.*

The meanings of the music control buttons are according to the buttons on the control terminal on the rear side of the jukebox (ref. to the prev. chapter). The receiver eye of the infrared remote control is located behind the hole on the top RH front side of the door. Beam this point directly if possible.

The common control terminal can be connected besides. It can be mounted outside to display the actual mode.

Batteries will not be delivered. Necessary are 4 micro cells type LR03 (AAA).

To open the battery compartment move the cover like shown in the picture.

Needed battery type and position of the batteries in the hand transmitter are shown on the casing.

Part no. of the hand transmitter: 0040443.



# Volume, sound and balance control - amplifier F91

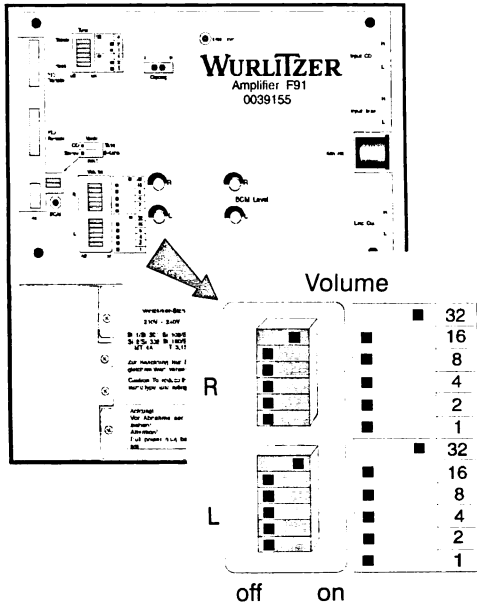

## IMPORTANT!

If all switches are in position OFF no volume,  
if all switches are in position ON, the  
maximum volume appears at power on !

## Pre-settings for volume

After power on of the jukebox or after pressing the button 'pre-set' the values of volume, bass and treble reach the values set by the DIP switches.

You can set the basic values for volume in 63 steps from no up to maximum volume.

At the amplifier front side, opening "Volume", you can find 6 so called DIP-switches for each channel. These switches have different valencies (1, 2 ... to 32). If you add all the values of the switches in position "ON" you will get the value for the set volume.

Consequently the switches 32 and 16 allow more a coarse adjustment the others a fine.

You can find the recommended settings on the amplifier cover.

## Pre-settings for bass and treble

Like-wise the values for bass and treble can be set. However for both channels together.

Three DIP-switches with the values 1, 2, 4 are provided for each bass and treble. You can choose 7 different steps from minimum to maximum. Adding all switches set to "ON" gets the set value.

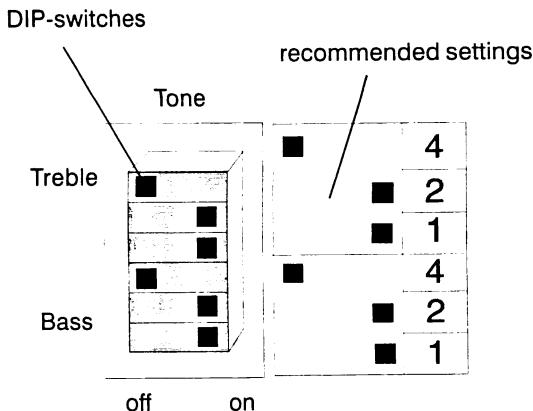

The recommended factory settings are printed on the amplifier cover.

## Note:

If you change the DIP-switch settings while the jukebox operates remember that the new settings will only take effect after having pressed the button 'PRESET' at the control terminal.

# Volume, sound and balance control - amplifier I84

## Caution!

Depending on the adjusted volume of the jukebox loudness levels of more than 70 dB can be reached.

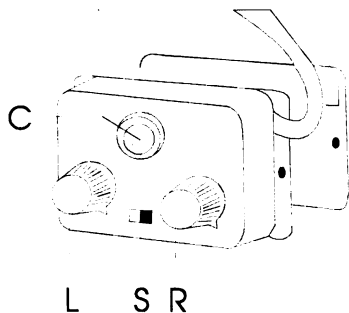

The volume control unit can be screwed off and may be mounted at another place as a remote control.

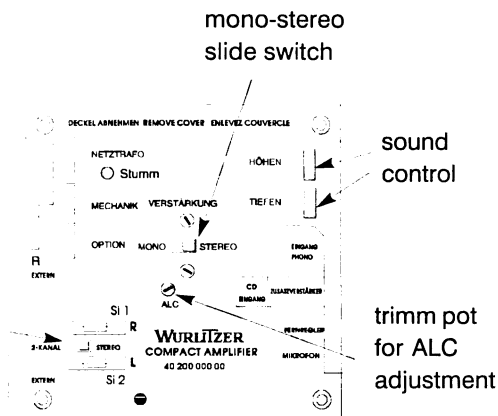

slide switch  
Stereo/2-Kanal

## Volume control

The control box, accessible from the rear side of the jukebox, is a separate unit and has two knobs (L and R). In „stereo mode“ (switch S in position stereo) only the left knob is effective. In position „2 Kanal“ (two channel) of the slide switch both channels are controllable separately.

## Treble and bass control

The treble and the bass controls at the top RH-side of the amplifier may be set to any position to suit local acoustic requirements. The Mono-Stereo switch may also be set to either position, however, it must be set to 'Stereo' if a stereophonic reproduction is desired.

## Slide switch „Stereo/2-Kanal“

In common operating mode the slide switch „Stereo/2-Kanal“ is in position „Stereo“. In Position „2-Kanal“ the cabinet speakers of the jukebox are switched to the left amplifier channel. Both sockets for the external speakers L and R are switched to the right amplifier channel.

If the slide switch of the volume control unit is switched to „2-Kanal“ a separate control of both cabinet speakers and external speakers (e.g. in another room) is possible (left knob for inside, right one for outside). The slide switch „Mono-Stereo“ has to be set to mode „Mono“.

## Automatic loudness controller

An internal automatic volume controller decreases the volume level of CDs recorded too loud to an output level defined by the ALC pot. So an equal volume level is reached. The ALC pot is pre-set from the factory. In left position of the adjustment pot the ALC does not operate.

# Volume, sound and balance control - amplifier I84

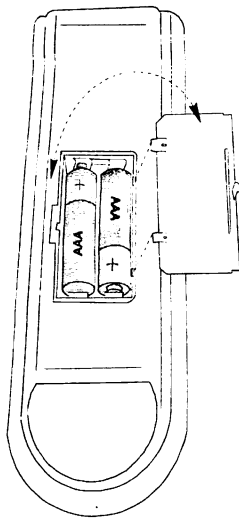
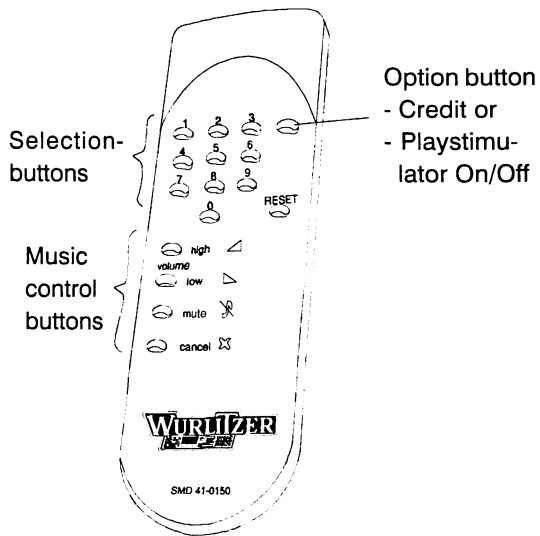

## Infrared remote control with selection buttons

As desired an infrared remote control will be installed from factory or can be delivered as a conversion kit (part no. 0047522; amplifier I84). If it is already installed you can find the hand transmitter in the cashbox. The receiver eye of the infrared remote control is located behind the hole on the top RH front side of the door. Beam it directly if possible.

## The meanings of the buttons...

- **BUTTONS 0 - 9 and RESET**  
If credit is given or free play is programmed a CD can be selected with the buttons 0 to 9 and R.

*Double button functions as required in the service programs (i.e. press button 5 -hold down- and press button R), are impossible. For this you only can use the keyboard of the jukebox.*

- **OPTION button:**  
This button can be used either as credit button or to switch on and off the continuous play function.
- **HIGH:**  
Increases the volume.
- **LOW:**  
Decreases the volume.

The jukebox saves the actual volume if it is switched off.

- **MUTE:**  
The first button operation switches the sound off. The next operation switches it on e.t.c. ('Toggle-function').
- **CANCEL:**  
Cancels the playing track. If 'albumplay' is enabled the next track will be played.

Batteries will not be delivered. Two micro cells Typ LR03 (AAA) are needed.



# The internal clock

---

Example:



———— weekday  
———— year

## Set year and weekday

To display the year and the weekday press selection button 2:

The weekdays are assigned to numbers as shown.

0 = Sunday	4 = Thursday
1 = Monday	5 = Friday
2 = Tuesday	6 = Saturday
3 = Wednesday	

To program press selection button 2 -hold down- and press selection button R. Release both buttons. Enter the right year with two digits, then enter a 0 followed by the number of the weekday.

## Exit the service program:

1. Set the slide switch 'SERVICE' at the SCC unit to OFF.
2. Press 'LT' button.

The changer starts an initialisation run. After this the jukebox is ready to operate.

# Automatic random select (Playstimulator)

---

*If the playstimulator is programmed the jukebox plays random tracks of the CDs in magazines registered in the service program level 1, button 5. CDs declared as BGM CDs (ref. to the next chapter) will not be used! The time between the last track played by inserted money and the first random track of the playstimulator is programmable from 1 up to 98 min. This time is also the repeat time between two random plays. The volume is the same as in normal operation. The playstimulator will be interrupted immediately when a selection is made and remains after having played the selected track(s).*

## The playstimulator only works

- if Back Ground Music is not activated at the same time
- if time is programmed correctly
- if no credit left

Example:



## Repeat time programming

To program the repeat time for the playstimulator (service program level 2):

1. Set the slide switch 'SERVICE' at the SCC-unit to ON.
2. Press 'LT' button.
3. Press selection button R -hold down- and press selection button 0 than release both buttons.
4. Press selection button 2. Service level 2 is reached. Display is: 2\_ \_ \_.

Press selection button 9 . The display shows three digits.

Repeat time is set to 5 minutes.

This digit enables or disables the CONTINUOUS PLAY MODE, random tracks one after another.

- 0 = CONTINUOUS PLAY OFF,
- 1 = CONTINUOUS PLAY ON.

# Automatic random select (Playstimulator)



Continuously playing  
of random tracks.

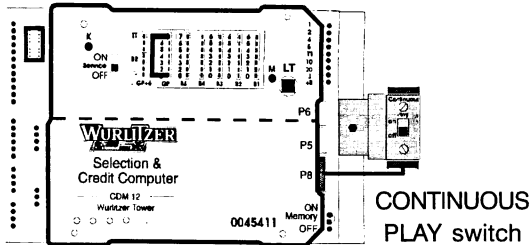

no random plays



Continuous random plays,  
however in conjunction  
with start and stop time.



After a played random  
track the jukebox waits  
about 5 minutes before it  
starts the next one.

## Operating modes:

- You can set the jukebox in an easy way to CONTINUOUS PLAY MODE by programming the digit CONTINUOUS PLAY to '1'. An additional programming of the clock and the start and stop time is not necessary.
- By means of an optional installed switch you can also switch the box to CONTINUOUS PLAY MODE without any need of entering the service program. Part number of this switch is 0034410. It has to be connected to P8 of the SCC unit.
- A more precise programming in conjunction with the internal clock and the start, stop and repeat time is possible if the digit CONTINUOUS PLAY is set to '0'. A correct programming of all these items is necessary.

**To program** press selection button 9 -hold down- and press selection button R. Release both buttons. Now enter the digit for CONTINUOUS PLAY and the REPEAT TIME with three digits.

To check the settings:  
Press button 9 again.

Random tracks will only be played in the time between start and stop time. The programming of this 'time window' is described as follows.

# Automatic random select (Playstimulator)

## Programming start and stop time

*If start and stop time is programmed the jukebox only plays random tracks in this time period.*

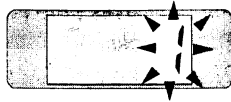

Press selection button 8. The display shows at first a flashing 1. This means 'start time'.



Then the time will be displayed, here 14.05 o'clock (2.05 p.m.).



Press selection button 8 once again. The display shows now a flashing 2. This means 'stop time'.



Then the time will be displayed, here 18.30 o'clock (6.30 p.m.).

### IMPORTANT:

**You can not program the Playstimulator over 24.00 o'clock (e.g. 23.00 to 2.00 o'clock) !**

To reprogram press selection button 8 - hold - and press selection button R. Release both buttons. The digital display goes dark. Enter the start and stop time with eight digits.

Example: The jukebox should play random tracks from 09.00 in the morning to 17.00 in the afternoon.

Enter:

0 - 9 - 0 - 0 - 1 - 7 - 0 - 0

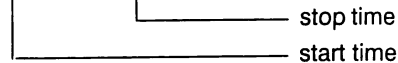

Then press selection button R.

The display shows 2 \_ \_ \_ (service program, level 2).

To check the start time:

Press selection button 8.

To check the stop time:

Press selection button 8 again.

### Exit the service program:

1. Set the slide switch 'SERVICE' at the SCC unit to OFF.
2. Press 'LT' button.

The changer starts an initialisation run. After this the jukebox is ready to operate.

### If the Playstimulator does not work:

Check if:

- the clock is set correctly ?
- start and stop time is programmed?
- repeat time is set correctly (not 0)?
- BGM play mode is disabled (ref. to next chapter).
- credits are still in memory.



## Automatic random select (Playstimulator)



Continuously playing  
of random tracks.

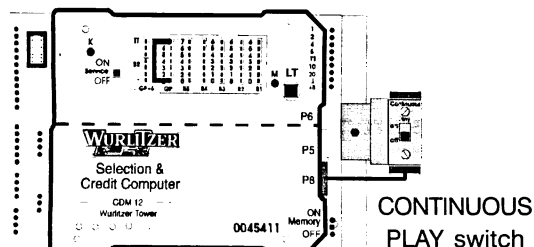

no random plays



Continuous random plays,  
however in conjunction  
with start and stop time.



After a played random  
track the jukebox waits  
about 5 minutes before it  
starts the next one.

### Operating modes:

- You can set the jukebox in an easy way to CONTINUOUS PLAY MODE by programming the digit CONTINUOUS PLAY to '1'. An additional programming of the clock and the start and stop time is not necessary.
- By means of an optional installed switch you can also switch the box to CONTINUOUS PLAY MODE without any need of entering the service program. Part number of this switch is 0034410. It has to be connected to P8 of the SCC unit.
- A more precise programming in conjunction with the internal clock and the start, stop and repeat time is possible if the digit CONTINUOUS PLAY is set to '0'. A correct programming of all these items is necessary.

**To program** press selection button 9 -hold down- and press selection button R. Release both buttons. Now enter the digit for CONTINUOUS PLAY and the REPEAT TIME with three digits.

To check the settings:  
Press button 9 again.

Random tracks will only be played in the time between start and stop time. The programming of this 'time window' is described as follows.

# Automatic random select (Playstimulator)

## Programming start and stop time

If start and stop time is programmed the jukebox only plays random tracks in this time period.

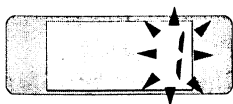

Press selection button 8. The display shows at first a flashing 1. This means 'start time'.



Then the time will be displayed, here 14.05 o'clock (2.05 p.m.).

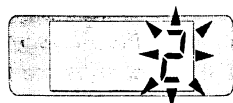

Press selection button 8 once again. The display shows now a flashing 2. This means 'stop time'.



Then the time will be displayed, here 18.30 o'clock (6.30 p.m.).

### IMPORTANT:

You can not program the Playstimulator over 24.00 o'clock (e.g. 23.00 to 2.00 o'clock) !

To reprogram press selection button 8 - hold - and press selection button R. Release both buttons. The digital display goes dark. Enter the start and stop time with eight digits.

Example: The jukebox should play random tracks from 09.00 in the morning to 17.00 in the afternoon.

Enter:

0 - 9 - 0 - 0 - 1 - 7 - 0 - 0

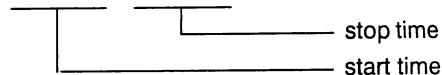

Then press selection button R.

The display shows 2 \_ \_ \_ (service program, level 2).

To check the start time:

Press selection button 8.

To check the stop time:

Press selection button 8 again.

## Exit the service program:

1. Set the slide switch 'SERVICE' at the SCC unit to OFF.
2. Press 'LT' button.

The changer starts an initialisation run. After this the jukebox is ready to operate.

## If the Playstimulator does not work:

Check if:

- the clock is set correctly ?
- start and stop time is programmed?
- repeat time is set correctly (not 0)?
- BGM play mode is disabled (ref. to next chapter).
- credits are still in memory.

# Back Ground Music (BGM)

## Amplifier F91

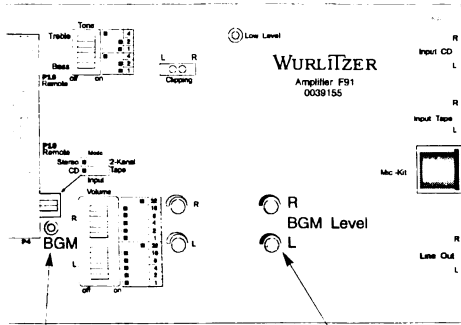

BGM light emitting diode (yellow), indicates whether BGM is active.

## Amplifier I84

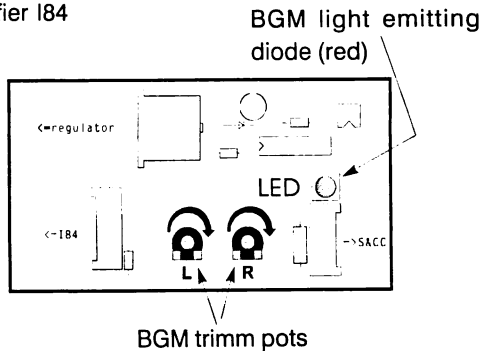

BGM trimm pots



Example:  
5 CDs reserved for BGM  
repeat time 10 min.

If BGM is programmed and activated a random track from the CDs declared for BGM will be played. The time between the last selected played track and the first BGM track is programmable between 1 and 98 minutes. This time is also the repeat time between two BGM tracks.

The volume by BGM reproduction is reduced compared to the normal volume. It is adjustable with the two BGM pots (RH channel / LH channel) on the F91 amplifier or on the BGM level adapter (if an I84 amp is installed). BGM mode is active when the according LED lights. Once the BGM mode is activated it is not possible to operate the Playstimulator.

If a selection is made by means of coin insertion the track being played will be interrupted immediately. Two intervals can be programmed for each weekday.

To enable BGM (service program, level 3) :

1. Set the slide switch 'SERVICE' at the SCC-unit to ON.
2. Press 'LT' button.
3. Press selection button R -hold down- and press selection button 0 than release both buttons.
4. Press selection button 3. Service level 3 is reached. Display is: 3 \_ \_ .

## Number of BGM CDs and BGM repeat time

Press selection button 7, the display shows e.g.:

repeat time between the single BGM tracks (10 min.)

BGM-continuous play = 99

BGM OFF = 00

number of BGM CDs; disabled for Playstimulator!

**To program** press selection button 7 -hold down- and press selection button R. Release both buttons. The display goes dark. Enter the number of CDs and the repeat time by means of the selection buttons with 8 digits.

# Back Ground Music (BGM)



## Start position for BGM CDs and configuration

Press button 8. The start position of the BGM CDs is displayed in the left two digits. The RH digit indicates the actual BGM mode.

BGM mode

not used, always 0

start position of BGM CDs

You can determine the digit for the BGM mode as follows:

BGM mode	selection
You want to select BGM CDs by coin insertion too:	yes -> 0; no -> 1
You want that the jukebox plays BGM-CDs also if credit still exists:	yes -> 2; no -> 0
BGM start position over 100:	yes -> 4; no -> 0

Select the desired features and add the according code numbers. Enter the sum of the code numbers as the mode digit.

Example:

BGM-CDs not selectable by coin insertion . . . = 1

BGM-CDs should not be played at still existing credits . . . . . = 0

BGM start position over 100 . . . . . = 4

Mode number . . . . . = 5

**To program** press selection button 8 - hold - and press selection button R. The digital display goes dark. Enter start position followed by a '0' and the BGM mode with 4 digits!

BGM

# Back Ground Music (BGM)

## Table for weekdays:

<b>0 = Sunday</b>	<b>4 = Thursday</b>
<b>1 = Monday</b>	<b>5 = Friday</b>
<b>2 = Tuesday</b>	<b>6 = Saturday</b>
<b>3 = Wednesday</b>	

## BGM time zones at different weekdays

You can program each weekday differently with two intervals per day. The following steps are the same for the buttons 1 to 6 in service level 3 according to the table for weekdays.

1. Press button 0, the display shows flashing:



0 (LH) = Sunday  
1 means start time one,



then the time will be displayed,  
here 9.00 o'clock.

2. Press selection button 0 again, the display shows flashing:



0 (LH) = Sunday  
2 means stop time one,



then the time will be displayed,  
here 12.30 o'clock.

3. Press selection button 0 again, the display shows flashing:



0 (LH) = Sunday  
3 means start time two,



then the time will be displayed,  
here 20.00 o'clock.

4. Press selection button 0 again, the display shows flashing:



0 (LH) = Sunday  
4 means stop time two,

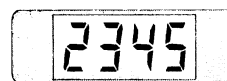

then the time will be displayed,  
here 23.45 o'clock.

## Back Ground Music (BGM)

---

**To program** press selection button 0 (or button 1 - 6 depending on the weekday to be programmed), hold it and press selection button R. The digital display goes dark. Enter the two time zones in four blocks containing four digits per block one after the other (16 digits).

### Examples:

The jukebox should play BGM on Tuesday from 9.30 to 11.45 and from 17.00 to 19.55. To program press selection button 2 - hold - and press selection button R. The digital display goes dark. Then enter 0-9-3-0-1-1-4-5-1-7-0-0-1-9-5-5.

If the jukebox should play BGM on Wednesday from 17.00 to 19.55 only, then program on selection button 3 as described: 1-7-0-0-1-9-5-5-0-0-0-0-0-0-0-0. The second time zone has to be filled with zeros. Also this programming is possible: 0-0-0-0-0-0-0-0-1-7-0-0-1-9-5-5.

**Repeat this procedure until all weekdays are programmed (selection buttons 0 to 6).**

Meaning of the digits to be entered in the example.

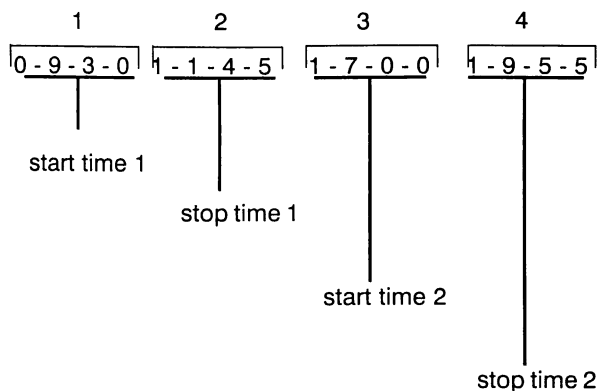

### Exit the service program:

1. Set the slide switch 'SERVICE' at the SCC unit to OFF.
2. Press 'LT' button.

The changer starts an initialisation run. After this the jukebox is ready to operate.

## Further programming options

---

### Number of tracks played successively on the same disc

*The display shows the maximum number of tracks played successively from the same disc if more tracks had been selected. Presetted value = 04 tracks, i.e. after four tracks from this CD it will be taken back to the magazine, and the next CD stored in the selection memory will be played. If selections for the previous CD still exist, they will be played later.*

*This option to limit the tracks played from one CD is more useful for operators. For individual use this value can be set up to 99.*

To change this value (service program, level 2) :

1. Set the slide switch 'SERVICE' at the SCC-unit to ON.
2. Press 'LT' button.
3. Press selection button R -hold down- and press selection button 0 than release both buttons.
4. Press selection button 2. Service level 2 is reached.  
Display is: 2\_ \_ \_.
5. Press selection button 3, the display shows e.g.:

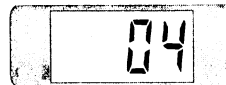

04 is factory pre-setting for number of tracks played successively on the same disc.

**To program** press selection button 3 - hold - and press selection button R. The digital display goes dark. Enter the desired setting by means of the selection buttons with two digits.

**If you set this value to 01 all selections will be played in selection order.**

To check the settings:  
Press selection button 3 again.

### Exit the service program:

1. Set the slide switch 'SERVICE' at the SCC unit to OFF.
  2. Press 'LT' button.
- The changer starts an initialisation run. After this the jukebox is ready to operate.

## Further programming options

---

### Selective disabling of tracks

*You can disable up to maximum 25 different tracks of different CDs. If somebody selects a disabled track the digital display flashes. This shows that this track is not selectable.*

To disable tracks (service program level 2):

1. Set the slide switch 'SERVICE' at the SCC-unit to ON.
2. Press 'LT' button.
3. Press selection button R -hold down- and press selection button 0 than release both buttons.
4. Press selection button 2. Service level 2 is reached. Display is: 2\_ \_ \_.
5. Press selection button 4 the display shows e.g.:

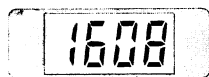

————— track number

————— CD number

Each operation of selection button 4 indicates the next disabled track, maximum 25 tracks.

After having reached the last disabled track, the first one is indicated again. If the display shows 0000 after the first button operation no track is disabled.

#### To program:

- a. Press selection button 4 - hold - and press selection button R. The digital display goes dark
- b. Enter at first the number of the CD to be disabled followed by the track (total four digits).
- c. To disable the next CD/track, press selection button 4 as often as display shows 0 0 0 0 .
- d. Press selection button 4 again - hold - and press selection button R. The digital display goes dark. Then enter CD and track to disable.
- e. Continue programming for the next track with step c.

**To enable a disabled track: When a track is indicated, press button 4 - hold - and press selection button R and enter first the number of the CD followed by 0 0. To enable all disabled tracks enter 0 0 0 0 (4 times 0).**



## Further programming options

---

### Selection and credit memory reset by power off:

*The function memory reset will cancel remaining credits and selections by power OFF of the jukebox.*

To enable this function (service program level 1):

1. Set the slide switch 'SERVICE' at the SCC-unit to ON.
2. Press 'LT' button.
3. Press selection button R -hold down- and press selection button 0 than release both buttons.
4. Press selection button 1. Service level 1 is reached. Display is: 1\_ \_ \_.
5. Press selection button 9 the display shows e.g.:



----- digit for albumplay

----- digit for memory reset  
by power off

*This function has to be programmed with "Albumplay" (ref. to chapt. Track selection). A programmed 0 disables the function, a 1 enables it.*

**You can also reset the selection and credit memory by pressing the button "LT" on the Selection & Credit Computer.**

Press selection button 9 - hold - and press selection button R. The digital display goes dark. Enter the desired setting by means of the selection buttons with 2 digits.

To check, press selection button 9 again.

### Exit the service program:

1. Set the slide switch 'SERVICE' at the SCC unit to OFF.
2. Press 'LT' button.

The changer starts an initialisation run. After this the jukebox is ready to operate.

## Player and CD cleaning

---

*Dust, fingerprints or other dirt on the disc surface can cause skipping, jumping or sticking problems. Because of this never touch the surface of a disc! However it is rather easy to remove nicotine, dust or fingerprints.*

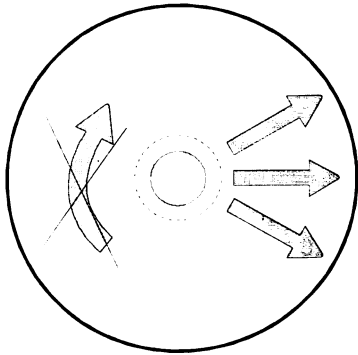

### **Nicotine, dust, fingerprints:**

Dust can be removed with a lintfree soft cloth. If necessary, remove heavy dirt or fingerprints with a moistened soft cloth soaked in a solution of water and a detergent. Never use record cleaning sprays or anti static sprays! Furthermore, do not use other types of cleaners containing benzene, thinner or other solvents. These liquids will cause damage to the surface of discs. Move the cloth from the inside towards the outside and not in circular motion.

### **Removing scratches:**

Use a soft cloth and a soft polish .

### **Laser lens cleaning:**

Smoke and dust soils the lens. It can be cleaned with a cue-tip soaked in a detergent (i.e. "B04" from KONICA). Place the tip on the lens and press down carefully.

#### **Caution!**

The whole laser unit is very sensitive!

- Move the cue-tip only in the direction shown in the picture (perp. to the sledge direction).
- Do not scratch the special treated surface of the lense.
- The cleaning solution must not run into the focus unit.

Keep away metal parts from the lens unit. A strong magnet is located underneath the lens. It attracts also smallest metal parts and so can block the complete unit.

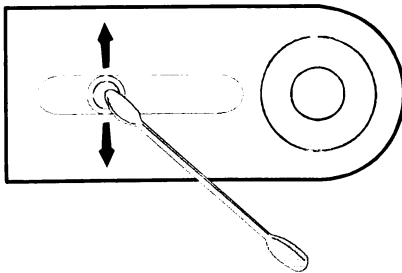

## Technical data

---

<b>Power supply</b>	110 - 240 Volt
<b>Power consumption with amplifier F91</b>	in standby: 146 Watts maximum: 540 Watts
<b>Power consumption with amplifier I84</b>	in standby: 146 Watts maximum: 205 Watts
<b>Dimensions</b>	Height: 151,0 cm Width: 79,6 cm Depth: 62,2 cm
<b>Weight</b>	137,0 kg
<b>Power output with amplifier F91</b>	2 x 170 Watts rms
<b>Power output with amplifier I84</b>	2 x 60 Watts rms

# Declaration of conformity - Konformitätserklärung

---

**Product Description:****Geräteart:****Jukebox / Musikbox****Model No.:****Typenbezeichnung:****Rave On****Directives Complied With:**

73/23/EEC

Low Voltage Directive

**Angewandte EG-Richtlinien:**

Niederspannungsrichtlinie

89/336/EEC

EMC Directive

Elektromagnetische Verträglichkeit

**Standards Used:****Technische Vorschriften:**

EN 50081-1

Electromagnetic Compatibility

Generic Emissions Requirements

Elektromagnetische Verträglichkeit

Fachgrundnorm Störaussendung

EN 50082-1

Electromagnetic Compatibility

Generic Immunity Requirements

Elektromagnetische Verträglichkeit

Fachgrundnorm Störfestigkeit

EN 60335-1

Safety Of Household And Similar

Electrical Appliances

Sicherheit Elektrischer Geräte Für Den

Hausgebrauch Und Ähnliche Zwecke

EN 60335-75

Safety Of Household And Similar

Electrical Appliances

Sicherheit Elektrischer Geräte Für Den

Hausgebrauch Und Ähnliche Zwecke

EN 55022

Limits And Methods Of Measurement Of Radio

Interference Characteristics Of Information

Technology Equipment.

Grenzwerte Und Meßverfahren Für Funkstörungen

Von Informationstechnischen Einrichtungen

**Signature****Unterschrift****Print Name****Gedruckter Name****Jürgen Obermeier****Position****Position****Chief Engineer / Technischer Leiter****Date****Datum****2nd January 1997 / 02. Januar 1997**

# Index

---

## A

albumplay 13  
amplifier F91 14  
amplifier I84 17  
automatic loudness controller I84 17

## B

Back Ground Music (BGM) 24  
bass and treble, pre-settings F91 16  
battery type for infrared remote control F91 15  
battery type for infrared remote control I84 18  
BGM number of CD's and BGM repeat time 24  
BGM start position for CD's and configuration 25  
BGM time zones at different weekdays 26  
button CANCEL, F91 13  
button CANCEL, I84 18  
button HIGH, I84 18  
button LOW, I84 18  
button LT 9  
button MODE, F91 14  
button MUTE, F91 14  
button MUTE, I84 18  
button OPTION, I84 18  
button PRESET, F91 14  
button R 12  
buttons F91, meanings 14  
buttons I84, meanings 18

## C

CD covers, insertion 8  
CD handling precautions 7  
CDs, cleaning 31  
CDs, insertion 7  
CDs, position 6  
clock setting 19  
coin operation 10  
continuous play mode 22  
control terminal F91 13, 14  
control terminal I84 13, 17

## D

date setting 19  
declaration of conformity 33  
denomination label 10  
disabling of tracks 29  
display flashes 12

## E

electrostatic discharges 4  
exit the serviceprogram 9

## F

free play 10

## I

infrared remote control F91 15  
infrared remote control I84 18

## J

jumper in GP and BS 10

## K

keys 5

## L

label 7  
laser beam 4  
laser diode 4  
laser lens cleaning 31

## M

magazine 7  
memory reset by power off 30

## N

number of CDs in the magazine 9  
number of tracks played successively on the same  
disc 28

# Index

---

## P

player, cleaning 31  
playstimulator 21  
playstimulator does not work 23  
power on 6  
prism page system 8

## R

repeat time, playstimulator 21  
row BS 10  
row GP 10

## S

SCC-unit 9  
scratches, removal 31  
Selection & Credit Computer 9  
selection and credit memory reset 30  
shipping guards 5  
slide switch „Stereo/2-Kanal“, I84 17  
start and stop time, programming 23  
switch SERVICE 9

## T

technical data 32  
test credit 11  
title cards, insertion 8  
track selection 12  
treble and bass control I84 17

## U

unlocking 5

## V

volume control I84 17  
volume, pre-settings F91 16

## W

weekday setting 20

## Y

year setting 20

## **GERMANY**

Deutsche Wurlitzer GmbH  
Niederdorf 5  
D - 32351 Stemwede - Levern  
Phone: (0 57 45) 28 - 0  
Fax: (0 57 45) 2 82 20

## **GREAT BRITAIN**

Deutsche Wurlitzer U.K.  
6, Devonshire Court  
Victoria Road, Feltham  
Middlesex, TW13 7LU  
Phone: (0181) 867 0224  
Fax: (0181) 867 0227

Deith Leisure Ltd.  
Unit 2, Industrial Estate  
Leigh Close, New Malden  
Surrey KT3 3NL  
Phone: (0813) 36 1222  
Fax: (0813) 36 1487

## **USA**

Wurlitzer Jukebox Company  
235 Moonachie Road  
Moonachie, NJ 07074  
Phone: (201) 807 2616  
Fax: (201) 807 9543  
Web Site: <http://www.wurlitzer-jukebox.com>  
Email: [bubbles@wurlitzer-jukebox.com](mailto:bubbles@wurlitzer-jukebox.com)

## **AUSTRALIA**

Wurlitzer Australia Pty. Ltd.  
77 Allingham Street  
Bankstown N.S.W. 2200  
Phone: (02) 9791 0922  
Fax: (02) 9791 0683

## **NEW ZEALAND**

Wurlitzer Pty. Ltd.  
Unit 1, 83 Springs Road  
East Tamaki, Auckland  
P.O. Box 58 - 616 Greenmount  
Phone: (09) 27 46 010  
Fax: (09) 27 44 888