

# JOOJST

## DRAWING SET

FOR SERVICE . . .  
NOTE NEW TOLL-FREE  
TELEPHONE NUMBERS:

800-621-1253

IN ILLINOIS CALL:  
800-572-1324

*Williams*<sup>®</sup>   
**ELECTRONICS, INC.**

3401 N. California Ave.  
Chicago, IL 60618

Cable Address: WILCOIN, CHICAGO  
(312) 267-2240

## CONTENTS

<b>Interboard Wiring Diagram</b> .....	<b>1</b>
<b>CPU Board Assembly Drawing</b> .....	<b>2</b>
<b>CPU Board Logic Diagram (Sheet 1 of 2)</b> .....	<b>3</b>
<b>CPU Board Logic Diagram (Sheet 2 of 2)</b> .....	<b>4</b>
<b>Interface Board Assembly and Logic Diagram</b> .....	<b>5</b>
<b>ROM Board Assembly Drawing</b> .....	<b>6</b>
<b>ROM Board Logic Diagram</b> .....	<b>7</b>
<b>Power Supply Board Assembly Drawing</b> .....	<b>8</b>
<b>Power Supply Board Schematic Diagram</b> .....	<b>9</b>
<b>Power Wiring Diagram</b> .....	<b>10</b>
<b>Cabinet Wiring Diagram</b> .....	<b>11</b>
<b>D8224 Sound Board Assembly Drawing</b> .....	<b>12</b>
<b>D8224 Sound Board Schematic Drawing</b> .....	<b>13</b>

# INTERBOARD WIRING

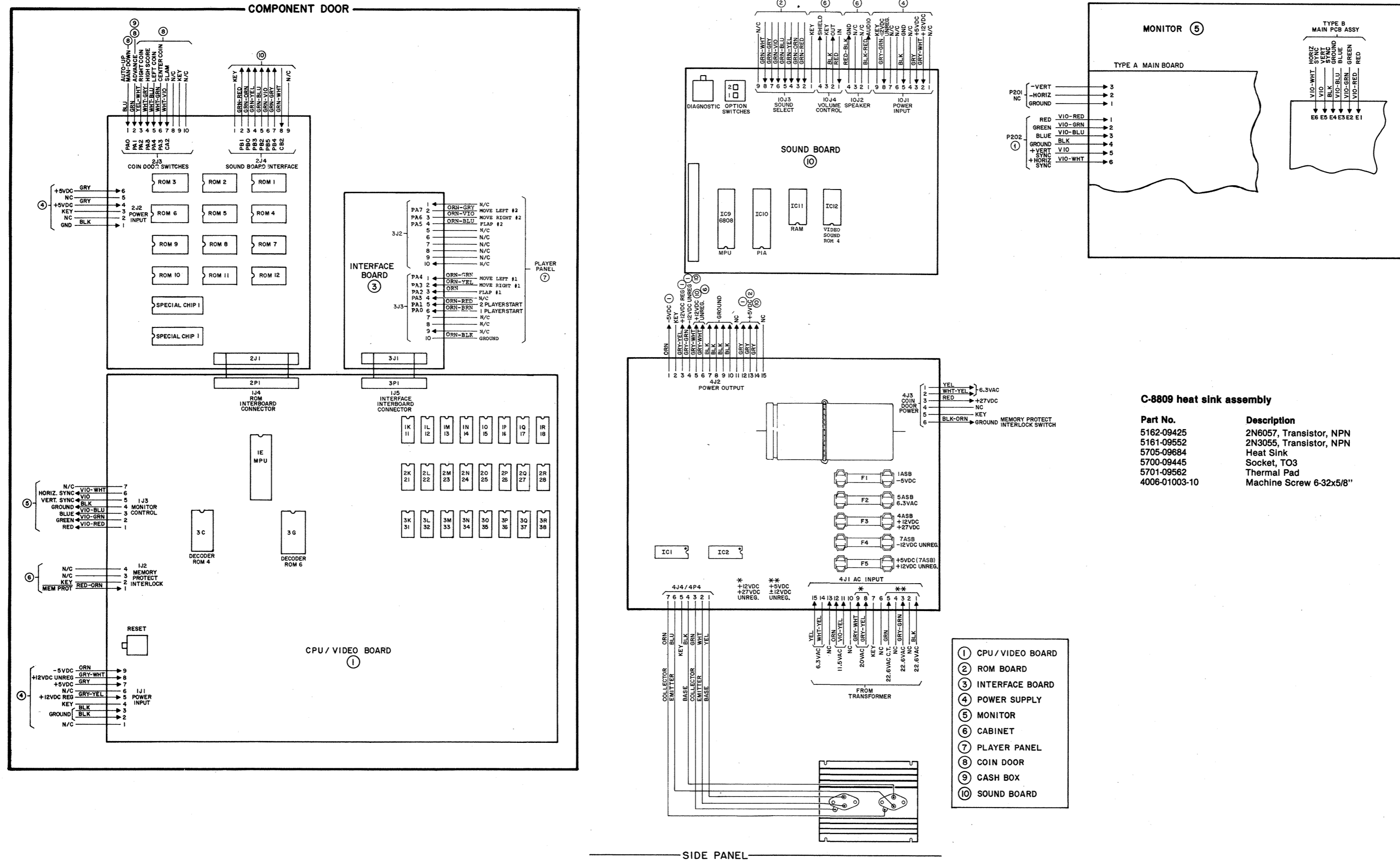

### C-8809 heat sink assembly

Part No.	Description
5162-09425	2N6057, Transistor, NPN
5161-09552	2N3055, Transistor, NPN
5705-09684	Heat Sink
5700-09445	Socket, TO3
5701-09562	Thermal Pad
4006-01003-10	Machine Screw 6-32x5/8"

- ① CPU/VIDEO BOARD
- ② ROM BOARD
- ③ INTERFACE BOARD
- ④ POWER SUPPLY
- ⑤ MONITOR
- ⑥ CABINET
- ⑦ PLAYER PANEL
- ⑧ COIN DOOR
- ⑨ CASH BOX
- ⑩ SOUND BOARD

ITEM NO.	PART NO.	PART DESIGNATION	DESCRIPTION	REQ'D. NO.
74	5791-09497-00	IJ3	7 PIN HEADER 09-65-1071	1
75	5791-09021-00	IJ1	9 PIN HEADER 09-65-1091	1
76	5019-09669-00	SR1	RESISTOR, 1K OHM 10 PIN SIP	1
77	5010-09534-00	W1, W2, W3	RESISTOR, C.F. 0 OHM 1/4 WATT	3
78	5340-09689-00	IC	5114 1K X 4 CMOS STATIC RAM	1
	5340-09647-00		6514 1K X 4 CMOS STATIC RAM	0
	5281-09483-00		74LS163 16 X 4 RAM	0
	5280-09425-00		7489 16 X 4 RAM	0
	5281-09716-00		74LS189 16 X 4 RAM	0
	5281-09715-00		74LS289 16 X 4 RAM	2
	5282-09711-00		74LS289 16 X 4 RAM	0
80	5441-09371-00	SW1	PUSH BUTTON SW. SPST	0
	5441-09312-00		PUSH BUTTON SW. DPT MOM.	1
81	16-8850-26		LABEL PCB ASSY I.D.	1
82				
83	5019-09786-00	SR2	SIP 4.7K $\Omega$ , 5R 6 PIN 5%125 W/R@70°C	1
84	5281-09856-00	1H, 3H, 4H	OCTAL LATCH 74LS373	3
85				
47	5010-09035-00	R64	RESISTOR, C.F. 47K OHM 5% 1/4W.	1
48	5551-09882-00	L3	COIL, 4.7MH, 3A	1
49	5010-09001-00	R2, R21, R24	RESISTOR, C.F. 330 OHM 5% 1/4W.	3
50	5010-09039-00	R56	RESISTOR, C.F. 10 OHM 5% 1/4W.	1
51	5043-09491-00	C89, C93	CAPACITOR, AXIAL 22 PFD. 1K V. $\pm$ 10%	2
52	5043-09492-00	C88	CAPACITOR, AXIAL 100 PFD. 50 V. $\pm$ 10%	1
53	5040-09545-00	C84	CAPACITOR, AXIAL 22 MFD. 10 V. $\pm$ 20%	1
54	5043-09065-00	C94 THRU C97	CAPACITOR, AXIAL 470 PFD. 50 V. XTR $\pm$ 20%	4
55	5043-09996-00	SEE NOTE #3	CAPACITOR, AXIAL .1 MFD. 50 V. $\pm$ 20%	85
56	5040-09421-00	C81, C82, C83	CAPACITOR, RADIAL 100 MFD. 25 V. $\pm$ 50-10%	3
57	5075-09059-00	ZR2	IN5990A 3.9 V. ZENER DIODE	1
58	5075-09018-00	ZR1	IN5996A 6.8 V. ZENER DIODE	1
59	5070-09019-00	D1, D2, D3, D4, D5, D6, D7, D8	IN4148 DIODE, SILICON	8
60	5070-09266-00	D9	IN5817 DIODE, SILICON	1
61	5160-09338-00	Q5, Q6, Q7, Q8, Q9, Q10, Q11, Q13	2N4401, TO-92 TRANSISTOR, NPN	8
62	5190-09016-00	Q1, Q2, Q3, Q4, Q12	2N4403, TO-92 TRANSISTOR, PNP.	5
63	5520-09495-00	CR1	12 MHZ CRYSTAL	1
64	5093-09845-00	C98-C105	CAPACITOR, AXIAL 1000 PFD 50V $\pm$ 20%	8
65	5880-09022-00	B1, B2, B3	BATTERY ALKALINE 1.5V. (AA)	3
66	5881-09021-00		BATTERY HOLDER *171	1
67	5700-09628-00		14-PIN IC SOCKET	0
68	5700-09006-00		16-PIN IC SOCKET	24
69	5700-09004-00		24-PIN IC SOCKET	2
70	5700-09085-00		40-PIN IC SOCKET	1
71	5791-09437-00	IJ5	20 PIN RIBBON CABLE HEADER	1
72	5791-09349-00	IJ4	40 PIN RIBBON CABLE HEADER	1
73	5791-09028-00	IJ2	4 PIN HEADER 09-65-1041	1

NOTES:

- 4116: 1K, 1L, 1M, 1N, 1O, 1P, 1Q, 1R, 2K, 2L, 2M, 2N, 2O, 2P, 2Q, 2R, 3K, 3L, 3M, 3N, 3O, 3P, 3Q, 3R
- 4.7K 4 RESISTOR: R26, R27, R28, R29, R32, R33, R35, R36, R37, R38, R39, R41, R50, R51, R52, R66, R67, R68, R69, R70, R71, R75, R84, R76, R77, R78
- 1 MFD. CAPACITORS: C1, C2, C3, C4, C5, C6, C7, C8, C9, C10, C11, C12, C13, C14, C15, C16, C17, C18, C19, C20, C21, C22, C23, C24, C25, C26, C27, C28, C29, C30, C31, C32, C33, C34, C35, C36, C37, C38, C39, C40, C41, C42, C43, C44, C45, C46, C47, C48, C49, C50, C51, C52, C53, C54, C55, C56, C57, C58, C59, C60, C61, C62, C63, C64, C65, C66, C67, C68, C69, C70, C71, C72, C73, C74, C75, C76, C77, C78, C79, C80, C86, C87, C90, C91, C92

4. FOR SCHEMATIC REFER TO 16-8809

BILL OF MATERIAL				
ITEM NO.	PART NO.	PART DESIGNATION	DESCRIPTION	REQ'D. NO.
1	5710-09656-00		BARE P.C. BOARD	1
2	5280-09073-00	4B	7400 QUAD 2-INPUT NAND	1
3	5280-08948-00	5H	7402 QUAD 2-INPUT NOR	1
4	5281-09215-00	TJ	74LS04 HEX. INVERTER	1
5	5280-09013-00	5A, 5K	7404 HEX. INVERTER	2
6	5280-09073-00	6F	7408 HEX. INVERTER	1
7	5280-09011-00	4L, 4M, 6I	7410 TRIPLE 3-INPUT NAND	3
8	5280-09475-00	3A, 6J	7411 TRIPLE 3-INPUT AND	2
9	5280-09530-00	5B	7420 DUAL 4-INPUT NAND	1
10	5280-09476-00	4C	7421 DUAL 4-INPUT AND	1
11	5280-09477-00	6E, 6G	7432 QUAD 2-INPUT OR	2
12	5280-09478-00	4D, 4K, 6K, 6C, 7F, 7G	7474 DUAL D-TYPE FLIP-FLOP	6
13	5280-09479-00	4A, 5J	7486 QUAD 2-INPUT EX-OR	2
14	5281-09480-00	7K	74LS107 DUAL J-K FLIP-FLOP	1
15	5281-09532-00	5G	74LS133 13-INPUT NAND	1
16	5281-09246-00	4G, 6H	74LS139 DUAL 2 to 4 LINE DECODER	2
17	5280-09481-00	3D, 3E, 4E, 4F	74LS53 DUAL 4 to 1 DATA INVERT.	4
18	5280-09468-00	1I, 1J, 2I, 2J, 3I, 3J, 4I, 4J	74166 8-BIT SHIFT REGISTER	8
19				
20	5281-09308-00	1G	74LS245 OCTAL BUS TRANSCEIVER	1
21	5281-09485-00	2C, 2H	74LS257 QUAD DATA MUX.	2
22	5370-08989-00	1D, 2D, 2G, 3E	8T97 HEX. TS BUFFER	0
	5281-09585-00		74LS367 HEX. BUS DRIVER	4
23	5281-09486-00	1A,	74LS374 OCTAL D-TYPE FLIP-FLOP	1
24	A-5342-09821	3C	UNIVERSAL VERT. DECODER ROM G	1
25	A-5342-09694	3G	UNIVERSAL HORIZ. DECODER ROM 4	1
26	5551-09848-00	L1, L2, L4	COIL, 2.0MH, .5A	3
27	5281-09533-00	5I	74LS393 DUAL 4-BIT BIN. COUNTER	1
28	5340-09488-00	SEE NOTE #1	4116 (450 ns ACCESS) 16 K X 1 DYNAMIC RAM	24
29	5070-04258-00	D10	IN4001 DIODE	1
30	5280-09489-00	5C, 5D, 5E, 5F	9316 4-BIT BIN. COUNTER	4
31	5400-09490-00	1E	6809E MICROPROCESSOR	1
32	5010-09548-00	R10, R12, R14	RESISTOR, C.F. 68 OHM 2% 1/4W.	3
33	5010-09036-00	R65	RESISTOR, C.F. 100 OHM 5% 1/4W.	1
34	5010-09187-00	R4, R6, R7, R16, R19, R25	RESISTOR, C.F. 150 OHM 5% 1/4W.	6
35	5010-09508-00	R11, R13, R15	RESISTOR, C.F. 270 OHM 2% 1/4W.	3
36	5010-09416-00	R18	RESISTOR, C.F. 470 OHM 5% 1/4W.	1
37	5010-08992-00	R1, R20, R23	RESISTOR, C.F. 560 OHM 5% 1/4W.	3
38	5010-09358-00	R42, R52, R77, R48, R54, R74	RESISTOR, C.F. 1K OHM 5% 1/4W.	8
39	5010-09314-00	R3, R22	RESISTOR, C.F. 1.2K OHM 5% 1/4W.	2
40	5010-08998-00	R89, R72, R73	RESISTOR, C.F. 2.2K OHM 5% 1/4W.	3
41	5010-08997-00	R60, R63	RESISTOR, C.F. 2.7K OHM 5% 1/4W.	2
42	5010-08983-00	R30, R31, R40, R44, R55	RESISTOR, C.F. 3.3K OHM 5% 1/4W.	5
43	5010-08991-00	SEE NOTE #2	RESISTOR, C.F. 4.7K OHM 5% 1/4W.	1
44	5010-09034-00	R49, R46, R53	RESISTOR, C.F. 10K OHM 5% 1/4W.	3
45	5010-08174-00	R47, R55, R57, R62	RESISTOR, C.F. 22K OHM 5% 1/4W.	4
46	5010-09118-00	R61	RESISTOR, C.F. 33K OHM 5% 1/4W.	1

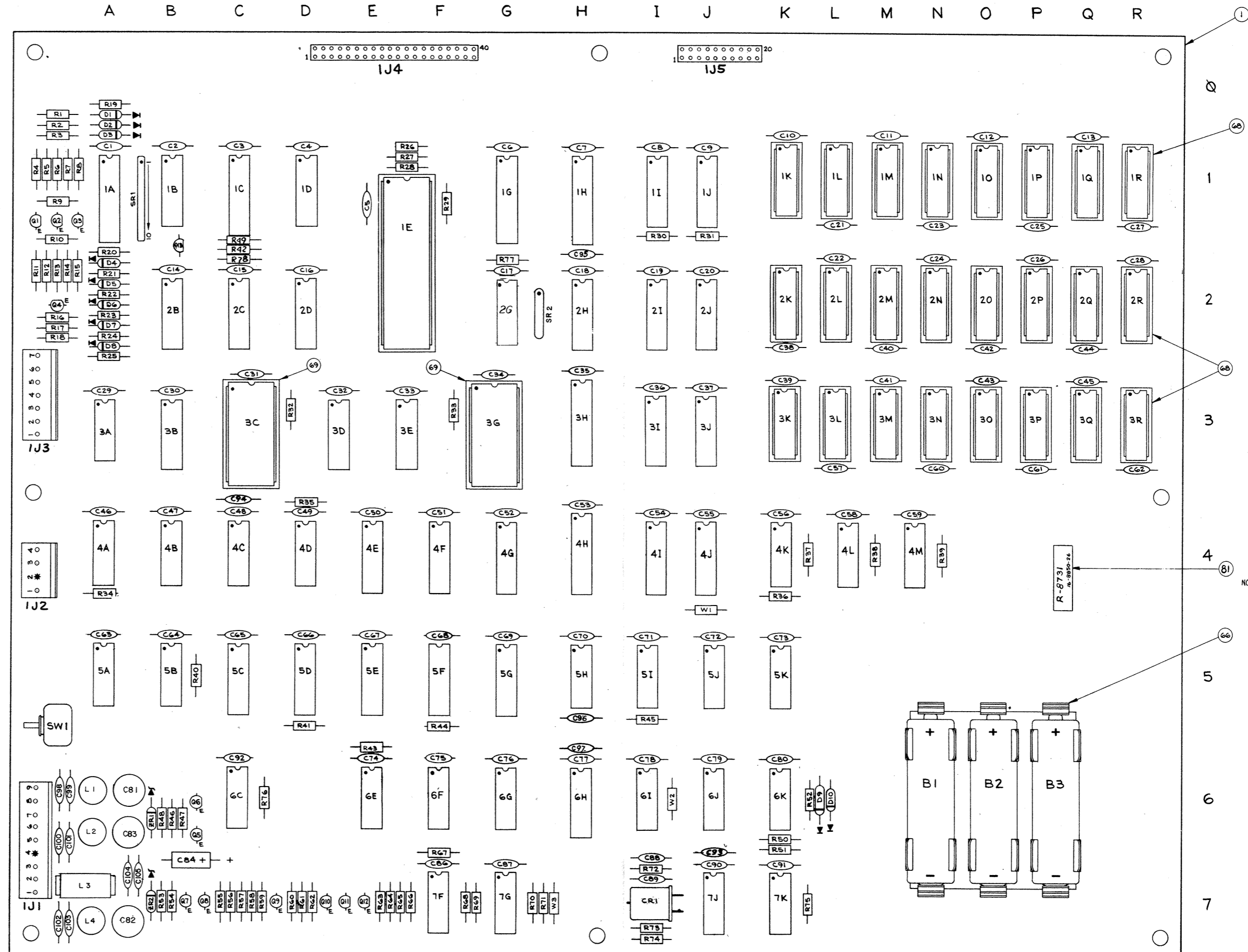

NOTE: LABEL LOCATION IS APPROXIMATE.

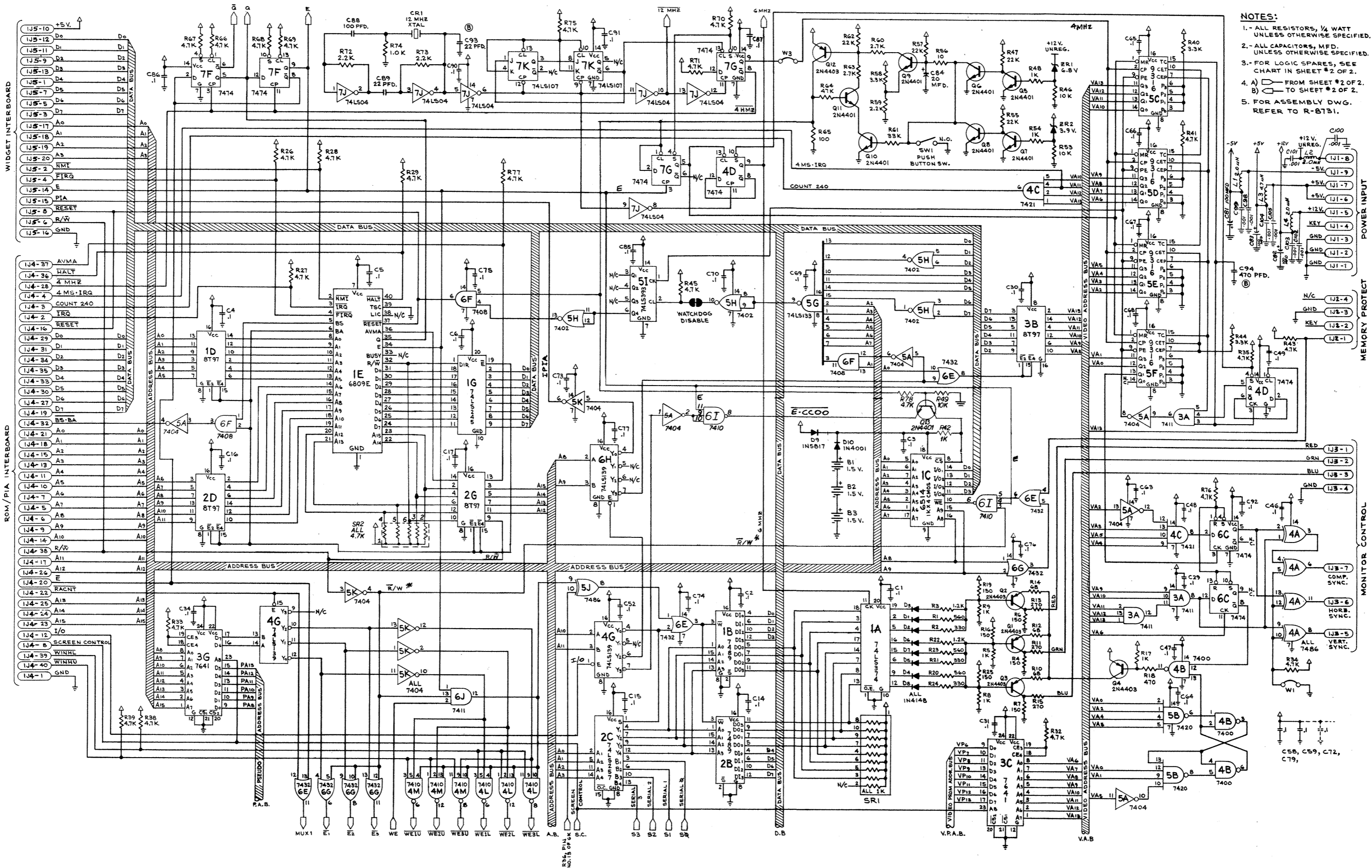

**NOTES:**

1. ALL RESISTORS, 1/4 WATT UNLESS OTHERWISE SPECIFIED.
2. ALL CAPACITORS, MFD. UNLESS OTHERWISE SPECIFIED.
3. FOR LOGIC SPARES, SEE CHART IN SHEET #2 OF 2.
4. A) FROM SHEET #2 OF 2. B) TO SHEET #2 OF 2.
5. FOR ASSEMBLY DWG. REFER TO R-8731.

R-8731 CPU Board Logic Diagram  
(Sheet 1 of 2)

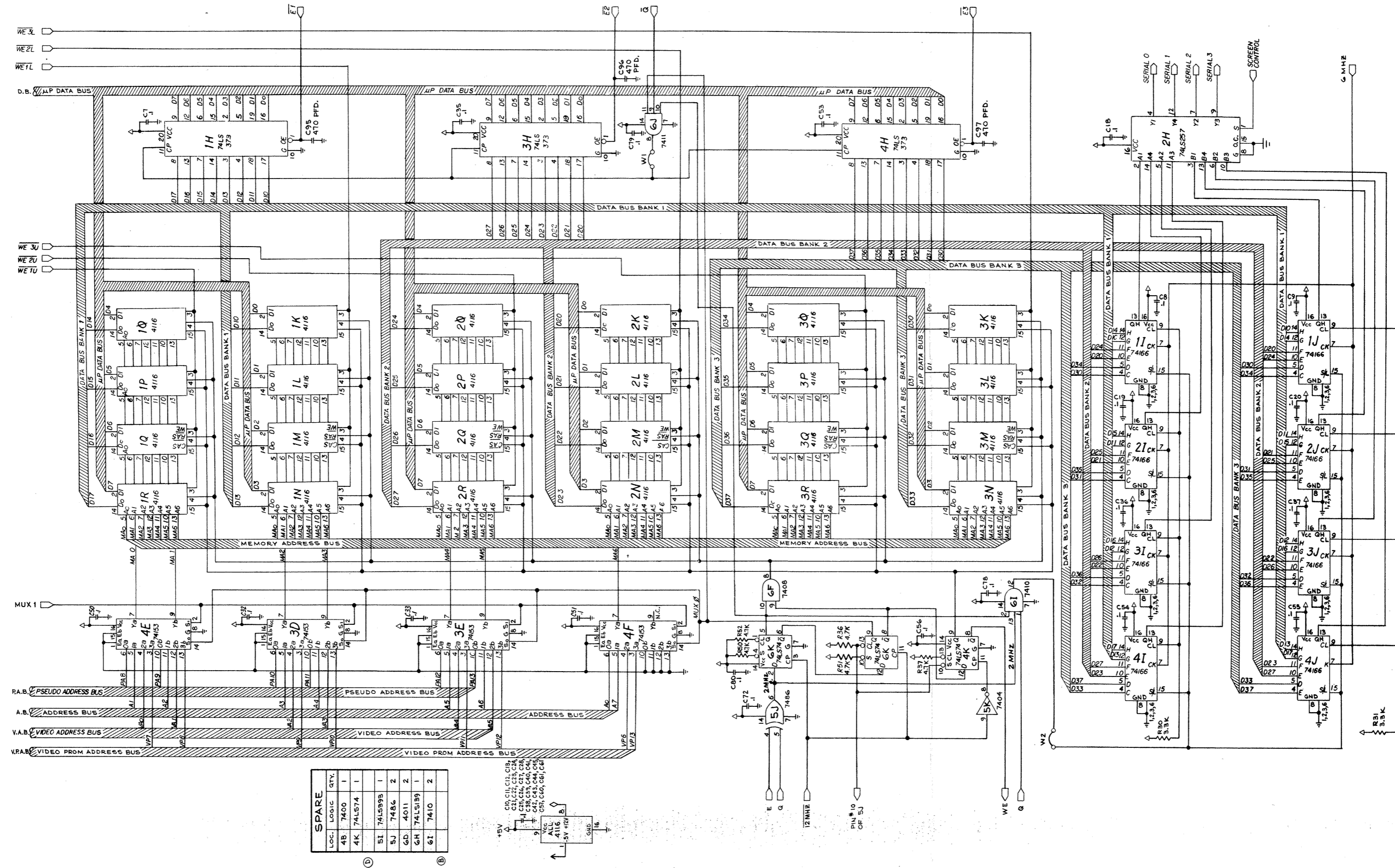

SPARE		
LOC.	LOGIC	QTY.
4B	7400	1
4K	74LS74	1
5I	74LS93	1
5J	7486	2
6D	4011	2
6H	74LS139	1
6I	7410	2

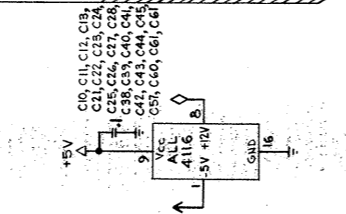

ITEM NO.	PART NO.	PART DESIGNATION	DESCRIPTION	NO. REQ'D.
1	5772-09680-00		BARE P.C. BOARD	1
2	5430-08972-00	IC2	6821 PIA	1
3	5310-08975-00	IC5, IC6, IC7	4049 CMOS HEX INVERTOR	3
4	5280-09013-00	IC1	7404 HEX INVERTER	1
5	5281-09485-00	IC3, IC4	74LS257 QUAD DATA MULTIPLEXER	2
6	5019-09362-00	SR1, SR2	4.7K OHM 9 RES. 10 PIN SIP	2
7	5010-09358-00	R2 THRU R19	RESISTOR, C.F. 1K OHM 5% 1/4 WATT	18
8	5010-08991-00	R1	RESISTOR, C.F. 4.7K OHM 5% 1/4 WATT	1
9	5010-09534-00	W1	RESISTOR, C.F. 0 OHM 1/4 WATT	1
10	5043-09065-00	C9 THRU C26	CAPACITOR, CERAMIC DISC. 470 PFD. 50 V. XTR 220%	18
11	5040-09421-00	C8	CAPACITOR, ELECT. RADIAL .100 MFD. 25 VOLT, 950-10%	1
12	5043-08980-00	C1 THRU C7	CAPACITOR, CERAMIC DISC. .01 MFD. 50 V. +80-20%	7
13	5795-09540-00	P1	20 PIN RIBBON CABLE ASSY.	1
14	5791-09444-00	3J2, 3J3	10 PIN HEADER 09-65-1101	2

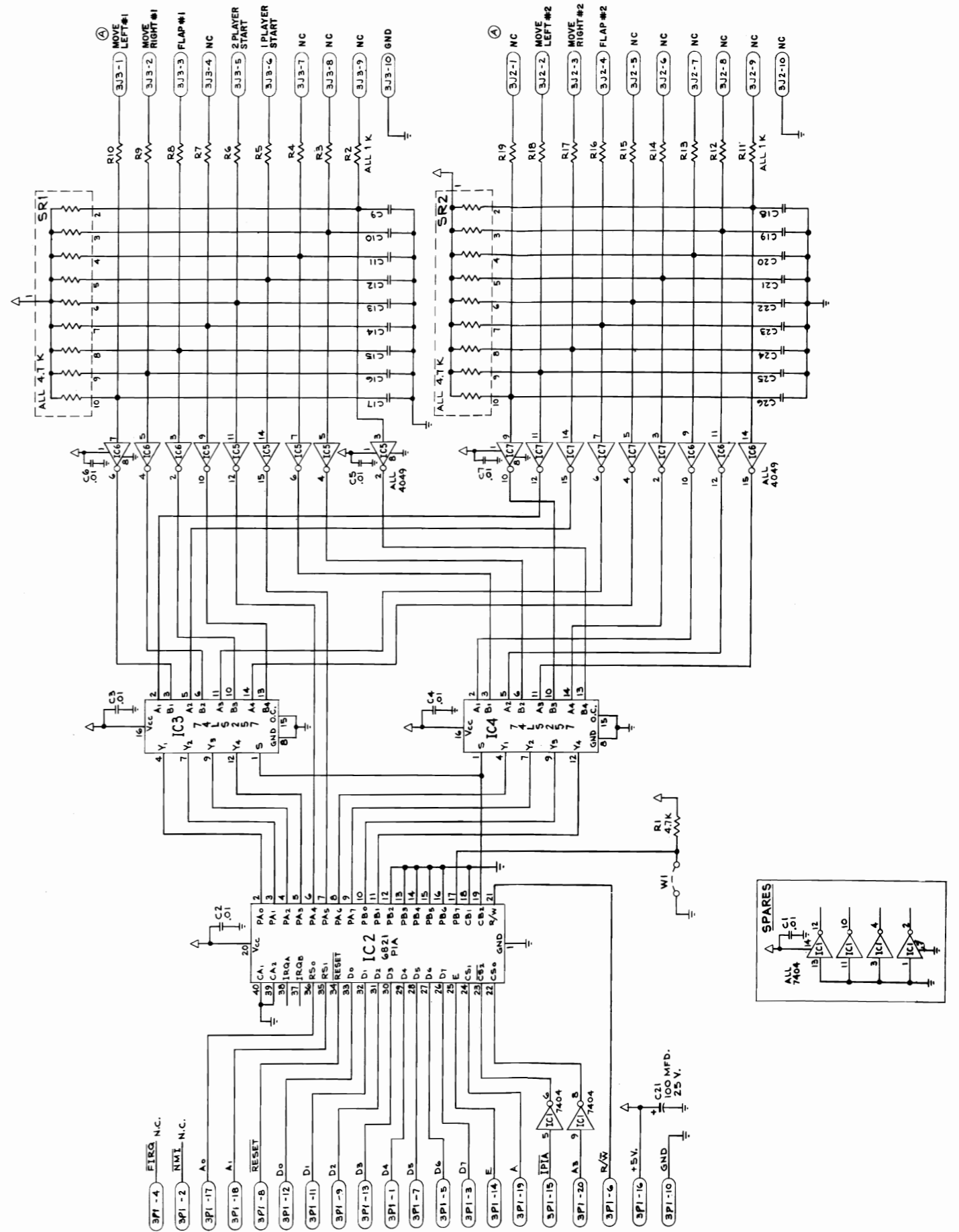
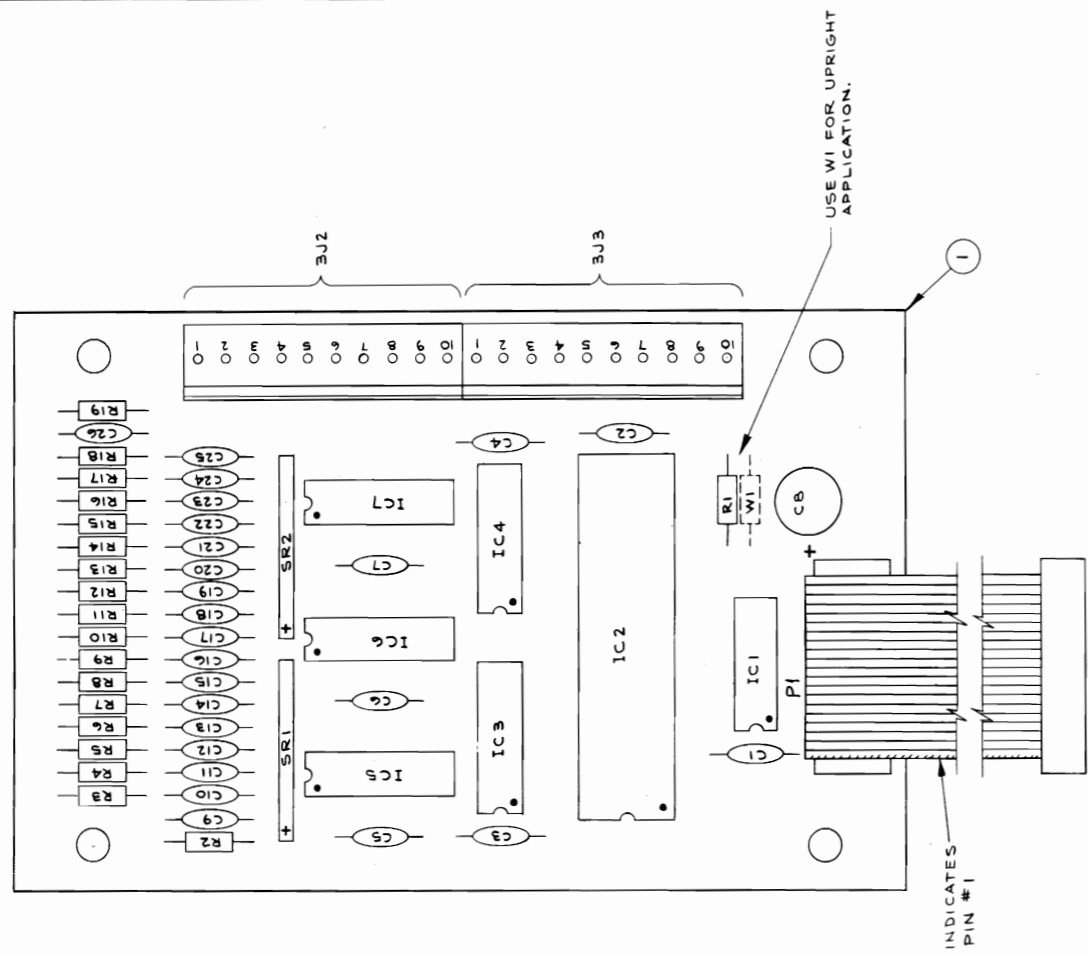

C-8783 Interface Board Assembly and Logic Diagram

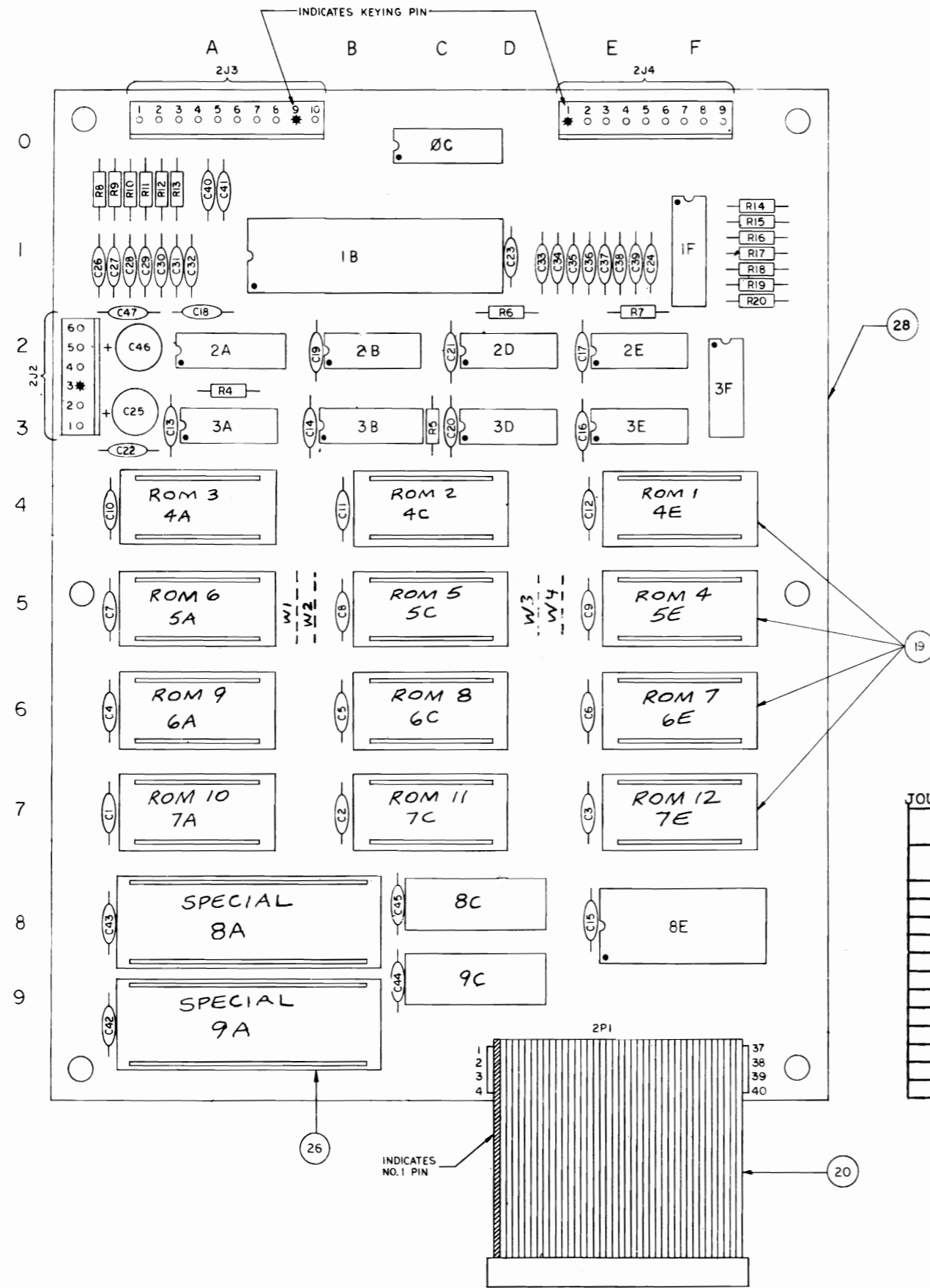

JOUST

CHIP CODE	ROM #	PART #
4E	ROM 1	A-5343-09961A
4C	ROM 2	A-5343-09962A
4A	ROM 3	A-5343-09963A
5E	ROM 4	A-5343-09964A
5C	ROM 5	A-5343-09965A
5A	ROM 6	A-5343-09966A
6E	ROM 7	A-5343-09967A
6C	ROM 8	A-5343-09968A
6A	ROM 9	A-5343-09969A
7A	ROM 10	A-5343-09970A
7C	ROM 11	A-5343-09971A
7E	ROM 12	A-5343-09972A
JUMPER		W2, W4

BILL OF MATERIALS				
ITEM NO.	PART NO.	PART DESIGNATION	DESCRIPTION	REQ'D NO.
1	5771-09840-00		BARE PC. BOARD	1
2	5280-09407-00	1F	7447BCD TO 7SEG LED DISPLAY	1
3	5280-09478-00	2D, 3A	7474 DUAL-D TYPE FLIP-FLOP	2
4	5281-09246-00	3B	74LS139 DUAL 2 TO 4 LINE DECODER	1
5	5280-09530-00	2B	7420 DUAL 4-INPUT NAND	1
6	5280-09475-00	3D	7411 TRIPLE 3 INPUT AND	1
7	5280-09013-00	3E	7404 HEX INVERTERS	1
8	5280-09551-00	2E	DUAL 4 INPUT 7425 NOR GATE WITH STROBE	1
9	5280-09010-00	8E	74154 4 TO 16 LINE DEC. / DEMULT.	1
10	5430-08972-00	1B	MC 6821 PIA	1
11	5019-09239-00	ØC	4.7K 15 RES 16 PIN DIP PACK	1
12	5010-09187-00	R14 THRU R20	RESISTOR C.F. 150 OHM 5% 1/4 W	7
13	5010-08991-00	R4 THRU R7	RESISTOR C.F. 4.7K OHM 5% 1/4W	4
14	5671-09411-00	3F	MAN 72A 7SEG LED DISPLAY	1
15	5043-08980-00	C1-C21, C23, C24, C42-45	CAP. CERAMIC .01 MFD 50V +80-20%	27
16	5040-09421-00	C25, C46	CAP ELEC 100 MFD. 25V RAD +50%-10%	2
17	5043-08996-00	C22, C47	CAP CERAMIC .1 MFD. 50V ±20%	2
18	5043-09065-00	C26 THRU C41	CAP CERAMIC 470 PFD. 50V AXIAL +/-20%	16
19	5700-09004-00		24-PIN IC. SOCKET	12
20	5795-09611-00	2P1	40 PIN RIBBON CABLE ASSY 5"	1
21	5791-09038-00	2J2	HEADER, 6 PIN, 09-65-1061	1
22	5791-09444-00	2J3	10 PIN MALE CONN 09-65-1101	1
23	5791-09027-00	2J4	9 PIN CONN 09-65-1091	1
24	5310-08975	2A	4049 INVERTING HEX BUF.	1
25	5010-09358-00	R8 THRU R13	RESISTOR C.F. 1K OHM 5% 1/4 W	6
26	5700-08985-00		40-PIN IC. SOCKET	2
28	D-9192		ROM/PIA BD. SUB-ASSEMBLY	1
29	SEE CHART	4A THRU 7E SEE CHART	GAME ROM ASSEMBLY	AS REQ'D
30	5010-09534-00	W1 THRU W4 SEE CHART	RESISTOR C.F. 0 OHM 1/4 WATT	AS REQ'D
31	5410-09866-00	8A, 9A	FULL CUSTOM I.C.	2
32	5281-09308-00	8C	I.C., 74LS245 OCTAL BUS / LINE DR / LINE RCVR	1



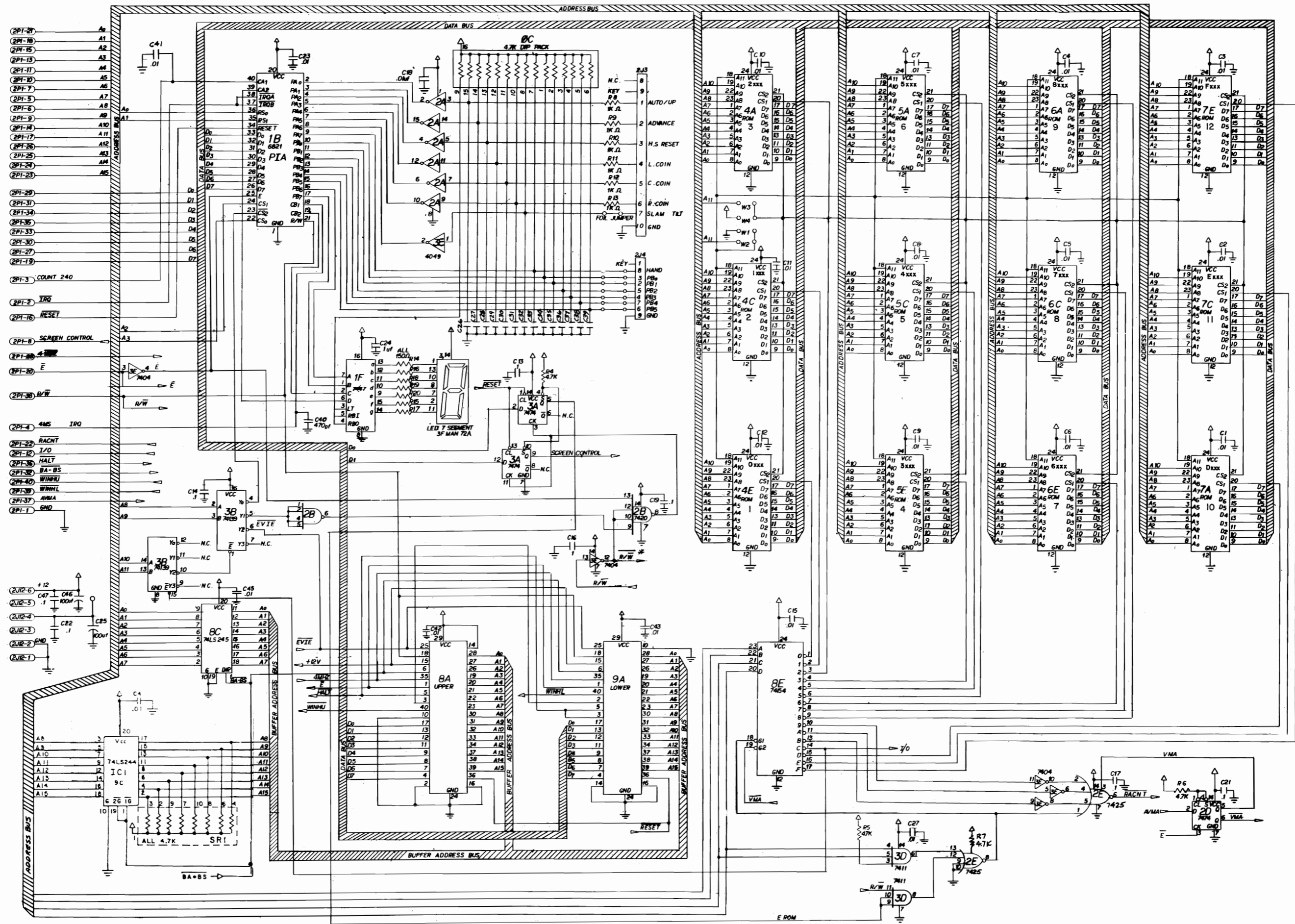

D-9144 ROM Board Logic Diagram

# BILL OF MATERIAL

ITEM NO.	PART NO.	PART DESIGNATION	DESCRIPTION	REQ'D NO.
1	5773-09679-00		BARE P.C. BOARD	1
2	5010-09085-00	R23	RESISTOR, 1.5K 5%, 1/4W	1
3	5010-09541-00	R13, R15	RESISTOR, 2.7K 2%, 1/4W	2
4	5010-09508-00	R21	RESISTOR, 870Ω 2%, 1/4W	1
5	5010-09428-00	R20	RESISTOR, 1.5K 2%, 1/4W	1
6	5010-09509-00	R16	RESISTOR, 1.1K 2%, 1/4W	1
7	5010-09510-00	R7	RESISTOR, 12K 2%, 1/4W	1
8	5010-09914-00	R4	RESISTOR, 1.2K 5%, 1/4W	1
9	5010-09916-00	R1, R14	RESISTOR, 470Ω 5%, 1/4W	2
10	5013-09542-00	R11	RESISTOR, 7.32K 1%, 1/4W	1
11	5013-09927-00	R12	RESISTOR, 4.99K 1%, 1/4W	1
12	5013-09926-00	R25	RESISTOR, 2.15K 1%, 1/4W	1
13	5012-09429-00	R3	RESISTOR, .12Ω 5%, 5W	1
14	5012-09512-00	R2	RESISTOR, .27Ω 5%, 5W	1
15	5012-09037-00	R27	RESISTOR, 0.4Ω 5%, 3W	1
16	5013-09665-00	R26	RESISTOR, 5.11K 1%, 1/4W	1
17	5010-09434-00	R6, R18	RESISTOR, C.F. 22Ω ±5% 1/4W	2
18	5010-09036-00	R5, R9, R17, R22	RESISTOR, C.F. 100Ω ±5% 1/4W	4
19	5010-09039-00	R8, R19	RESISTOR, C.F. 10Ω ±5% 1/4W	2
20	5010-09534-00	W1	RESISTOR, 0Ω	1
21	5043-08996-00	C6, C7	CAPACITOR, 0.1μF CERAMIC +80% -20% 50V	2
22	5040-09921-00	C2, C16	CAPACITOR, 100MFD, 25V RADIAL +50% -10%	2
23	5040-09422-00	C15	CAPACITOR, 97 MFD, 50V RADIAL +50% -10%	1
24	5040-09920-00	C3	CAPACITOR, 1000MFD, 25V RADIAL +75% -10%	1
25	5040-09919-00	C10	CAPACITOR, 18,000MFD 20V AXIAL +75% -10%	1
26	5040-09423-00	C5	CAPACITOR, 330 MFD 10V RADIAL +50% -10%	1
27	5040-09504-00	C14	CAPACITOR, 4700MFD 35V RADIAL +50% -10%	1
28	5043-09446-00	C1, C4 & C12	CAPACITOR, .1MFD, 50V AXIAL 25V -20 +80%	3
29	5043-08065-00	C9	CAPACITOR, 470 PFD 50V AXIAL XTR ±10%	1
30	5043-09492-00	C8	CAPACITOR, 100 PFD 50V AXIAL SEL ±5%	1
31	5040-09506-00	C13	CAPACITOR, 220MFD 16V RADIAL +50% -10%	1
32	5040-09493-00	C11	CAPACITOR, 22MFD 10V RADIAL +50% -10%	1
33	5070-06258-00	D1, D2 & D3	DIODE, 1N4001	3
34	5075-09406-00	ZR1	ZENER, 1N5234 ±5% (6.2V)	1
35	5075-09662-00	ZR2	ZENER, 1N5299 ±5% (14V)	1
36	5190-09430-00	Q3, Q4	TRANSISTOR, MPS 455	2
37	5130-09661-00	Q1, Q2	SCR 8 AMP, 100V	2
38	5250-09515-00	Q5	VOLTAGE REGULATOR, T905	1
39	5460-09424-00	IC1, IC2	VOLTAGE REGULATOR, 723	2
40	5100-09890-00	BR1	BRIDGE RECTIFIER, 35 AMP, 200V	1
41	5100-09513-00	BR2	BRIDGE RECTIFIER, 4.0A, 50V	1
42	5100-09544-00	BR3	BRIDGE RECTIFIER, 1.0A, 50V	1
43	5671-09018-00	LED1, LED2, LED3	LED, RED	3
44	5824-09298-00	TP1 - TP6	TERMINAL #1502-1 (TEST POINT)	4

(A)

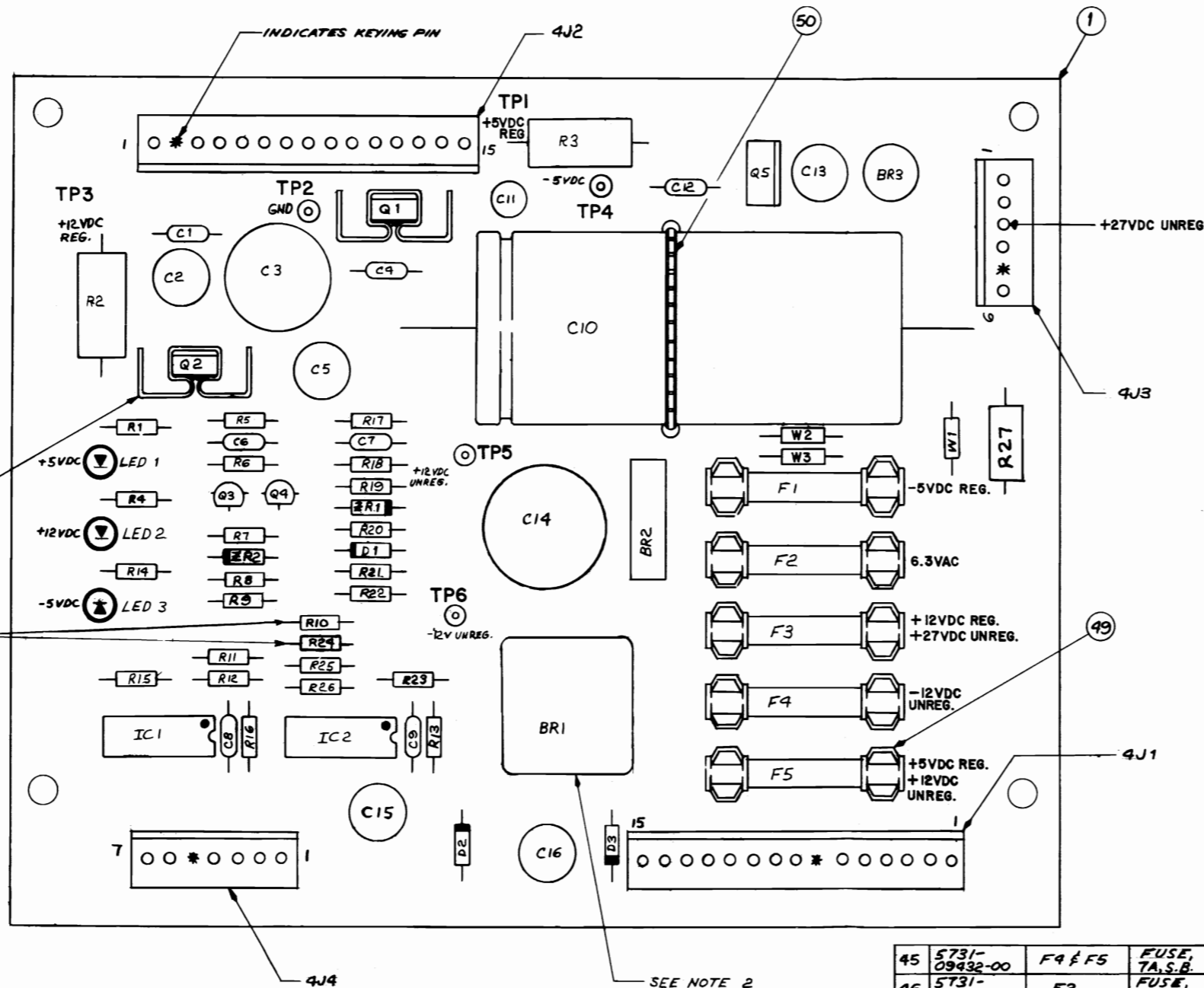

SEE NOTE 1

SEE NOTE 2

**NOTES:**

1. REMOVE R24 IF +5VDC IS GREATER THAN 5.25 VDC, REMOVE R10 IF +5VDC IS LESS THAN 4.75 VDC.
2. BR1 MUST BE MOUNTED 1/8" ABOVE SURFACE OF BOARD.
3. FOR SCHEMATIC REFER TO 16-8811.

45	5731-09432-00	F4 & F5	FUSE, TA, S.B.	2
46	5731-06314-00	F3	FUSE, 9A, S.B., 250V	1
47	5731-06569-00	F1	FUSE, 1A, S.B., 250V	1
48	5731-09651-00	F2	FUSE, 5A, S.B., 250V	1
49	5732-09178-00		FUSEHOLDER,	10
50	03-T520		TIE WRAP	1
51	5791-09074-00	4J1 & 4J2	HEADER, 15 PIN 09-65-1051	2
52	5791-09038-00	4J3	HEADER, 6 PIN 09-65-1061	1
53	5791-09497-00	4J4	HEADER, 7 PIN 09-65-1071	1
54	5705-09663-00		HEAT SINK	2
	5706-09688-00		HEAT SINK	0
55	5010-09682-00	R10	RESISTOR C.F. 51K ±5% 1/4W	1
56	5010-09324-00	R24	RESISTOR C.F. 27K ±5% 1/4W	1
ITEM NO.	PART NO.	PART DESIGNATION	DESCRIPTION	REQ'D NO.

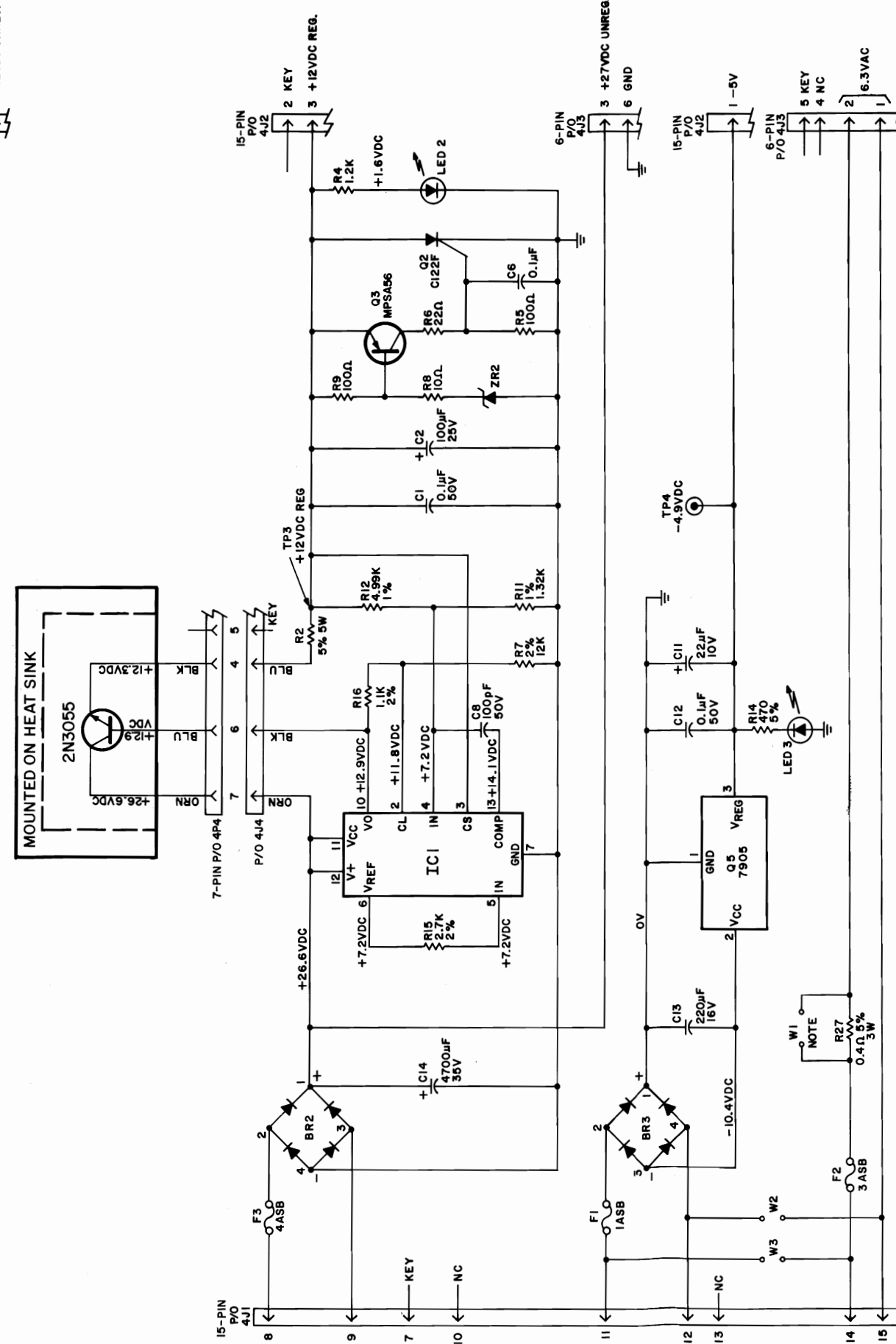
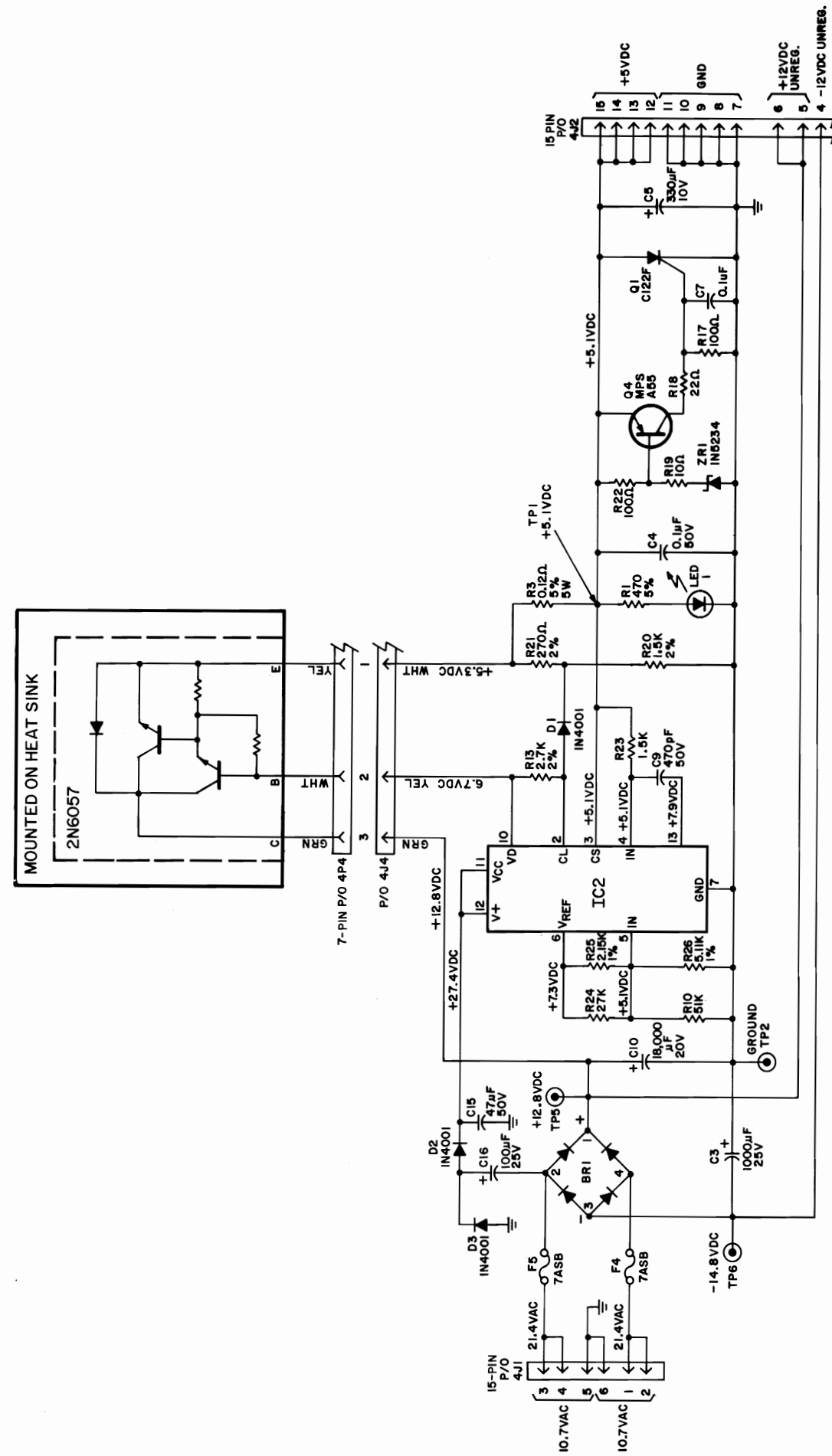

NOTE: JUMPERS W1, W2 & W3 ARE ALL N.C. IN JOUST-UPRIGHT GAMES. THESE GAMES USE POWER TRANSFORMER #5610-09668 WITH A 12.5VCT SECONDARY, ALLOWING 6.3V FOR GENERAL ILLUMINATION.

D-8784 Power Supply Board Schematic Diagram

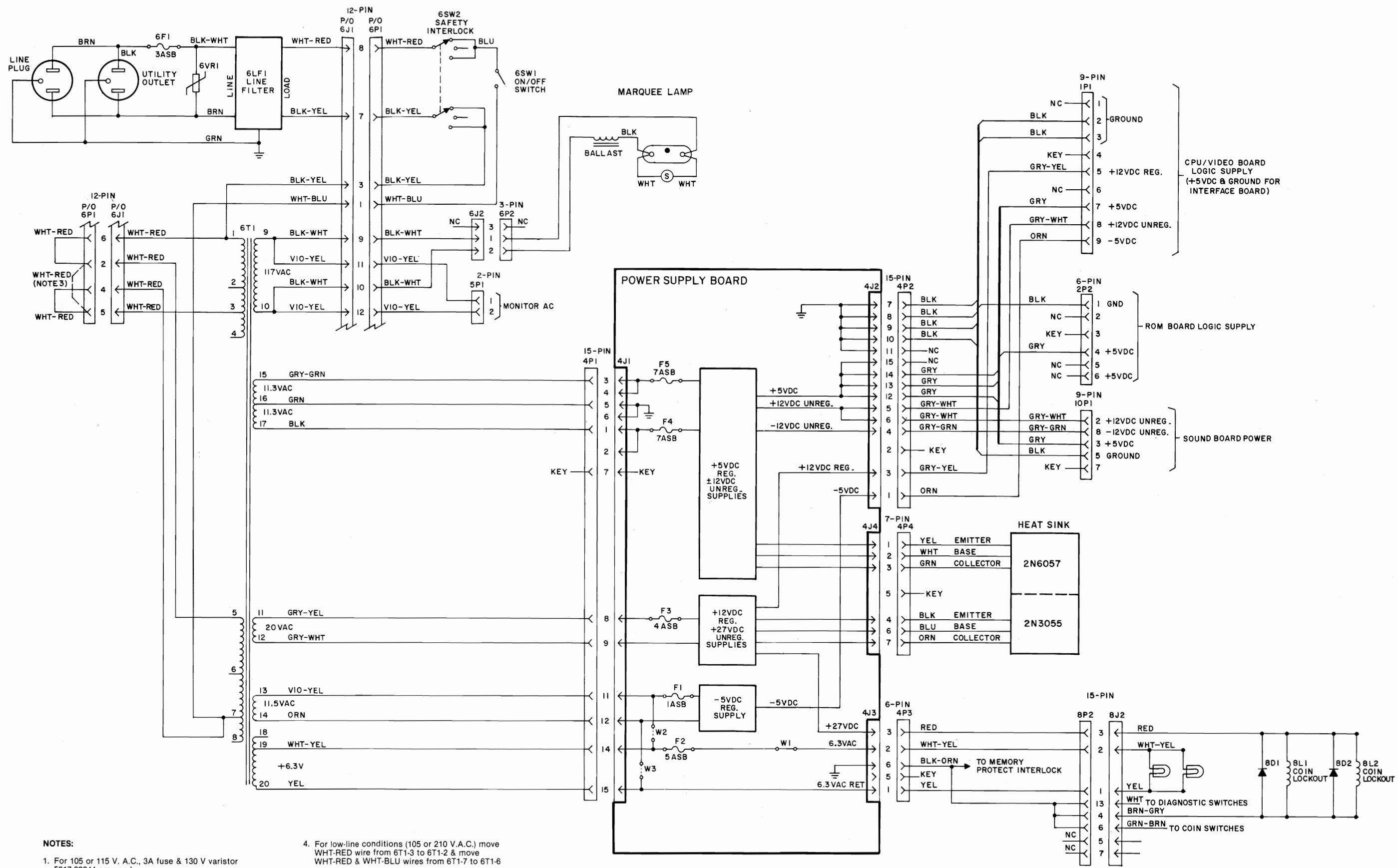

- NOTES:**
1. For 105 or 115 V. A.C., 3A fuse & 130 V varistor 5017-09044 are used.
  2. For 210 or 235 V.A.C., 1A fuse & 275V varistor 5017-09063 are used.
  3. Jumper wires on 6PI shown with solid lines are connected for 117 V.A.C. operation. Only the one shown with a dashed line is connected for 220 V.A.C. operation.

4. For low-line conditions (105 or 210 V.A.C.) move WHT-RED wire from 6T1-3 to 6T1-2 & move WHT-RED & WHT-BLU wires from 6T1-7 to 6T1-6
5. For high line conditions (135 or 240 VAC) move WHT-RED wire from 6T1-3 to 6T1-4 and move WHT-RED & WHT-BLU wires from 6T1-7 to 6T1-8

# CABINET WIRING

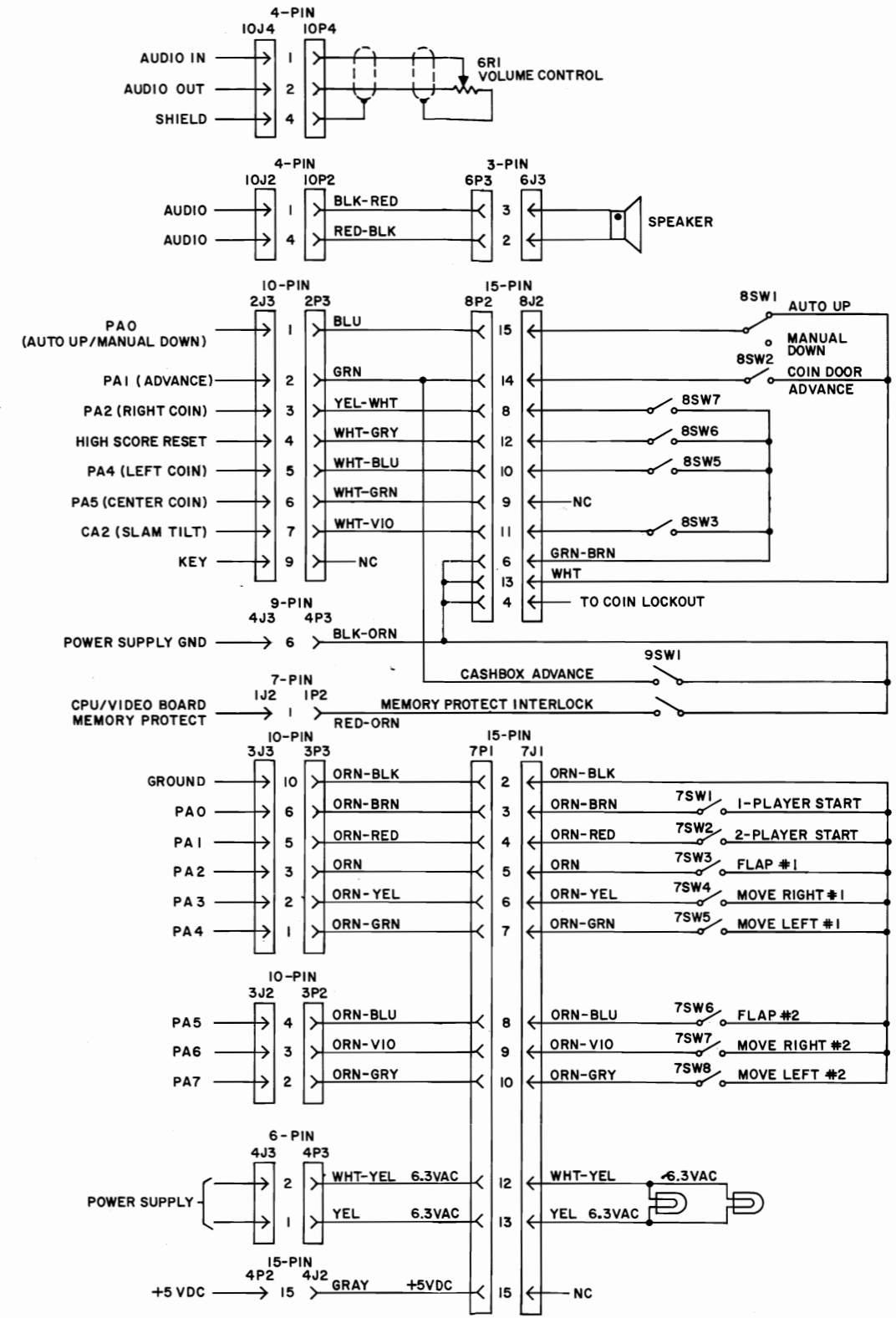

BILL OF MATERIAL

ITEM NO.	PART NO.	PART DESIGNATION	DESCRIPTION	REQ'D. NO.
1	01-2 01-146-6		BARE P.C. BOARD REV F	1
2	5370-09156-00	IC1	TDA 2002 V AUDIO AMPLIFIER	1
3	5280-09012-00	IC2	7442 BCD-DEC DECODER	1
4	5280-09073-00	IC3	7400 QUAD 2 INPUT NAND	1
5	5280-08973	IC4	7408 QUAD 2 INP. AND GATE	1
6	5310-09153-00	IC5	4050 BUFFER	1
7	5310-09154-00	IC6	4068 8 INPUT NAND GATE	1
8	5310-08971-00	IC7	4069 HEX INVERTER	1
9	5250-09157-00	IC8	7805 5 VOLT REG. W/TO 220 CASE	1
10	5430-08972-00	IC10	6821 P.I.A.	1
11	5340-09003-00	IC11	6810 RAM	1
12	5371-09152-00	IC13	1408 D/A CONVERTER	1
13	5160-08938-00	Q2, Q3, Q4	2N4401 NPN TRANSISTOR	3
14				
15	5075-09018-00	ZR1	1N5996A 6.8V ZENER DIODE	1
16				
17	5100-09357-00	BR1	MDA 200/3N253	1
18	5100-09158-00		BRIDGE RECTIFIER	0
19	5520-09020-00	Y1	3.58 Mhz CRYSTAL	1
20	5010-08991-00	R1,R18,R19,R21,R22, R27,R30,R31, R32	RESISTOR, FC, 4.7K OHM, 5% 1/4 WATT	9
21	5010-09036-00	R2 thru R10	RESISTOR, FC, 100 OHM, 5% 1/4W	9
22	5010-09358-00	R12,R15,R28,R36,R38	RESISTOR, FC, 1K OHM, 5% 1/4W	5
23	5010-09181-00	R14	RESISTOR, FC, 1 OHM, 10% 1/2 WATT	1
24	5010-09161-00	R16	RESISTOR, FC, 2.2 OHM, 5% 1/4 WATT	1
25	5010-09361-00	R17	RESISTOR, FC, 220 OHM, 5% 1/2 WATT	1
26	5010-08983-00	R23, R24, R26	RESISTOR, FC, 3.3K OHM, 5% 1/4 WATT	3
27	5010-09179-00	R25	RESISTOR, FC, 3.3M OHM, 5% 1/4 WATT	1
28	5010-09035-00	R29	RESISTOR, FC, 47K OHM, 5% 1/4 WATT	1
29	5010-09034-00	R33, R35, R37	RESISTOR, FC, 10K OHM, 5% 1/4 WATT	3
30	5010-09039-00	R34	RESISTOR, FC, 10 OHM, 5% 1/4 WATT	1
31	5043-08980-00	C1, C16 thru C23, C31	CAPACITOR, CER. .01 MFD. 50V. +80%, -20%	10
32	5043-09065-00	C2 thru C10	CAPACITOR, CER. 470 PFD. 50V. +20%	9
33	5043-09345-00	C11	CAPACITOR, CER. .001 MFD. +20% 100V.	1
34	5040-09365-00	C12, C30, C36	CAPACITOR, ELECT. 1 MFD. 63V. -10 +50%	3
35	5043-08996-00	C13, C24, C35	CAPACITOR, CER. .1 MFD. 50V. +20%	3
36	5040-09165-00	C14	CAPACITOR, ELECT. 1,000 MFD. 16V. +20%	1
37	5040-09164-00	C15	CAPACITOR, ELECT. 470 MFD. 10V. +20%	1
38	5040-08986-00	C25	CAPACITOR, ELECT. 100 MFD. 10V. +20%	1
39	5040-08893-00	C26	CAPACITOR, ELECT. 1,000 MFD. 25V. +20%	1
40	5040-09376-00	C27	CAPACITOR, ELECT. 4700 MFD. 16V. +20%	1
41	5043-09180-00	C28	CAPACITOR, CER. 47 PFD. 1K V. +20%	1
42	5040-09343-00	C29	CAPACITOR, ELECT. 10 MFD. 20V	1
43	5043-09169-00	C32, C33	CAPACITOR, CER. DISC, 27 PFD. 1KV. +10%	2
44	5041-09163-00	C34	CAPACITOR, TANTALUM 2.2 MFD. 15V. +20%	1
45	5041-09031-00	C37	CAPACITOR, TANTALUM 1 MFD. 25V. +20%	1
46	5641-09658-00	SW1	MOMENTARY SWITCH SPDT	1
47	5645-09330-00	DS1	2 STD, DIP SWITCH	1
48	5731-06314-00	F1, F2	4 AMP SLOW BLOW FUSE	2
49	5732-09178-00		FUSEHOLDER	4
50	5705-09172-00		HEAT SINK THERMALLOY #6072B	1
51	5705-09173-00		HEAT SINK THERMALLOY #6071B	1
52	5705-09199-00		HEAT SINK THERMALLOY #6030	1
53	5700-09004-00		24 PIN SOCKET	1
54	5700-08985-00		40 PIN SOCKET	1
55	5791-09027-00	10J1, 10J3	9 PIN MALE CONNECTOR 09-65-1091	2
56	5791-09028-00	10J2, 10J4	4 PIN MALE CONNECTOR 09-65-1041	2
57				
58	4006-01003-06		6-32x3/8" P-PH-S	3
59	4406-01117-00		6-32 HEX NUT	3
60	5010-09534-00		0 OHM RESISTOR	A/R
61	5824-09248-00	TP1 THR TP4	TERMINAL #1502-1	4
62	5010-09363-00	R11	RESISTOR, FC, 5.6K OHM 5% 1/4 WATT	1
63				
64	5019-09362-00	SR1	RESISTOR, 4.7K OHM 10 PIN SIP	1
65	03-7520-1		TIE WRAP	1
66	4703-00007-00		#6 EXT. LOCKWASHER	3
67	20-9229		THERMAL COMPOUND	.01

NOTES:

1. USE THERMAL COMPOUND BETWEEN IC1 AND IC8, AND HEAT SINKS.

2. CAUTION: AVOID STATIC DISCHARGE DAMAGE TO MOS LOGIC.

3. SYMBOLS SHOWN ON COMPONENTS ARE FOR REFERENCE ONLY.

DO NOT SCREEN OR STAMP.

4. OBSERVE INDEX MARK OF ALL INTEGRATED CIRCUITS;

DIODES D1, D2, AND ZR1;

CAPACITORS C12, C14, C15, C25, C26, C27;

CONNECTORS 10J1, 10J2, 10J4, 10J3, 10J5;

POSITION OF TRANSISTORS Q1, Q2, Q3, Q4.

5. JUMPERS

- W3) W2)
- W4) W6)
- W5) IN W9) OUT
- W10) W11)
- W12)
- W13)

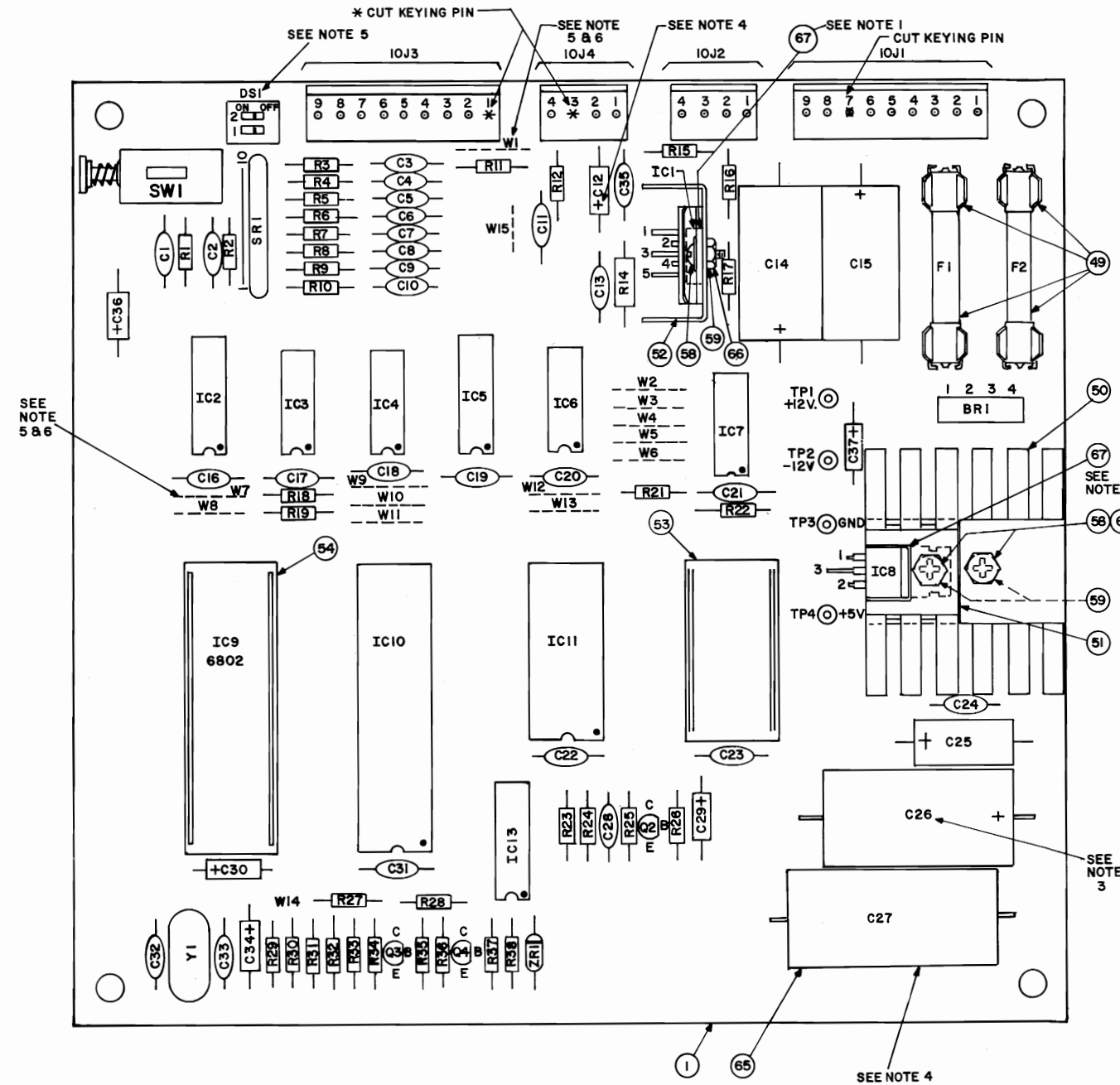

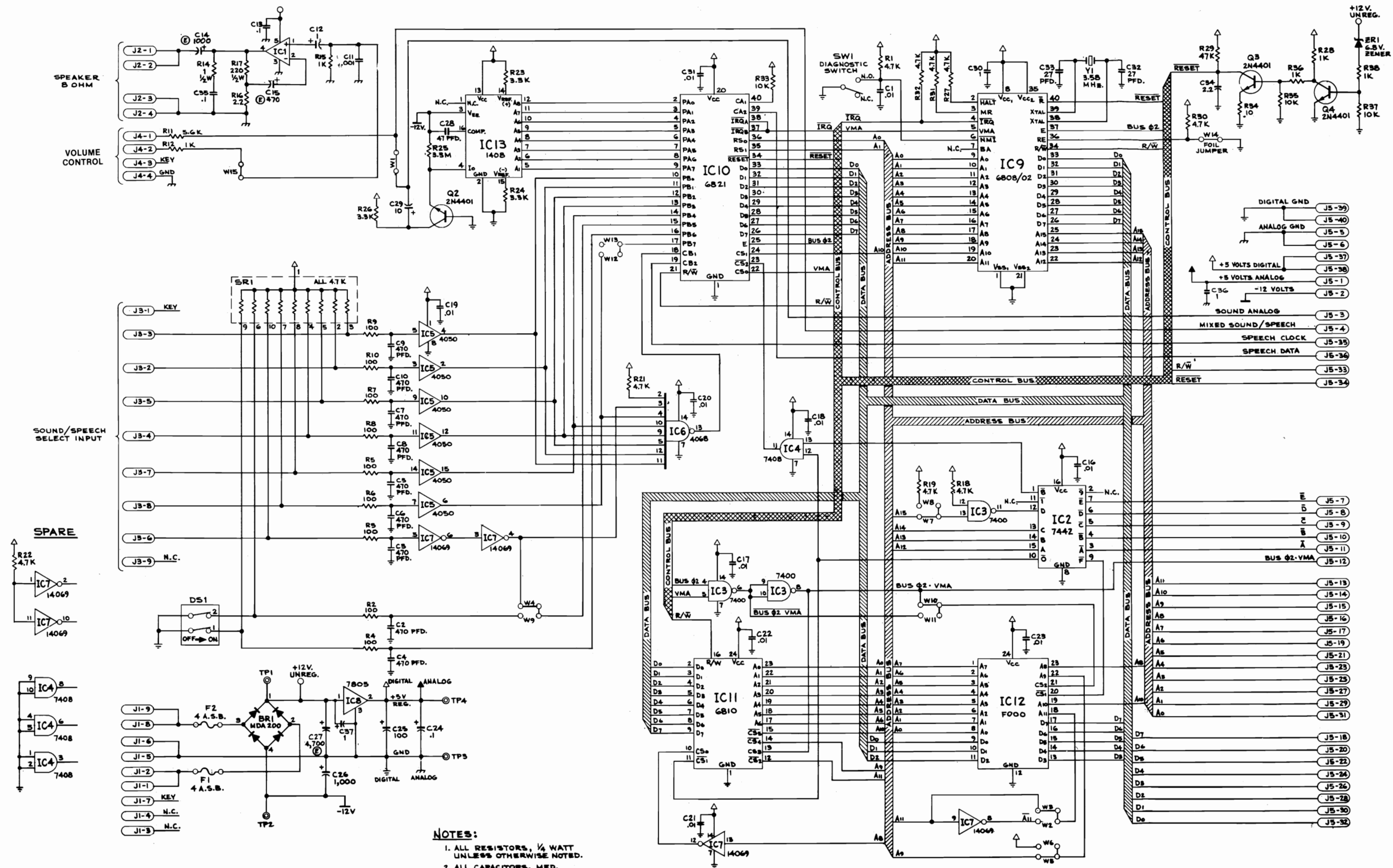

**NOTES:**  
 1. ALL RESISTORS, 1/4 WATT UNLESS OTHERWISE NOTED.  
 2. ALL CAPACITORS, MFD. UNLESS OTHERWISE NOTED.