

# **namco**<sup>®</sup>

## **TIME CRISIS 2 D1Xe**

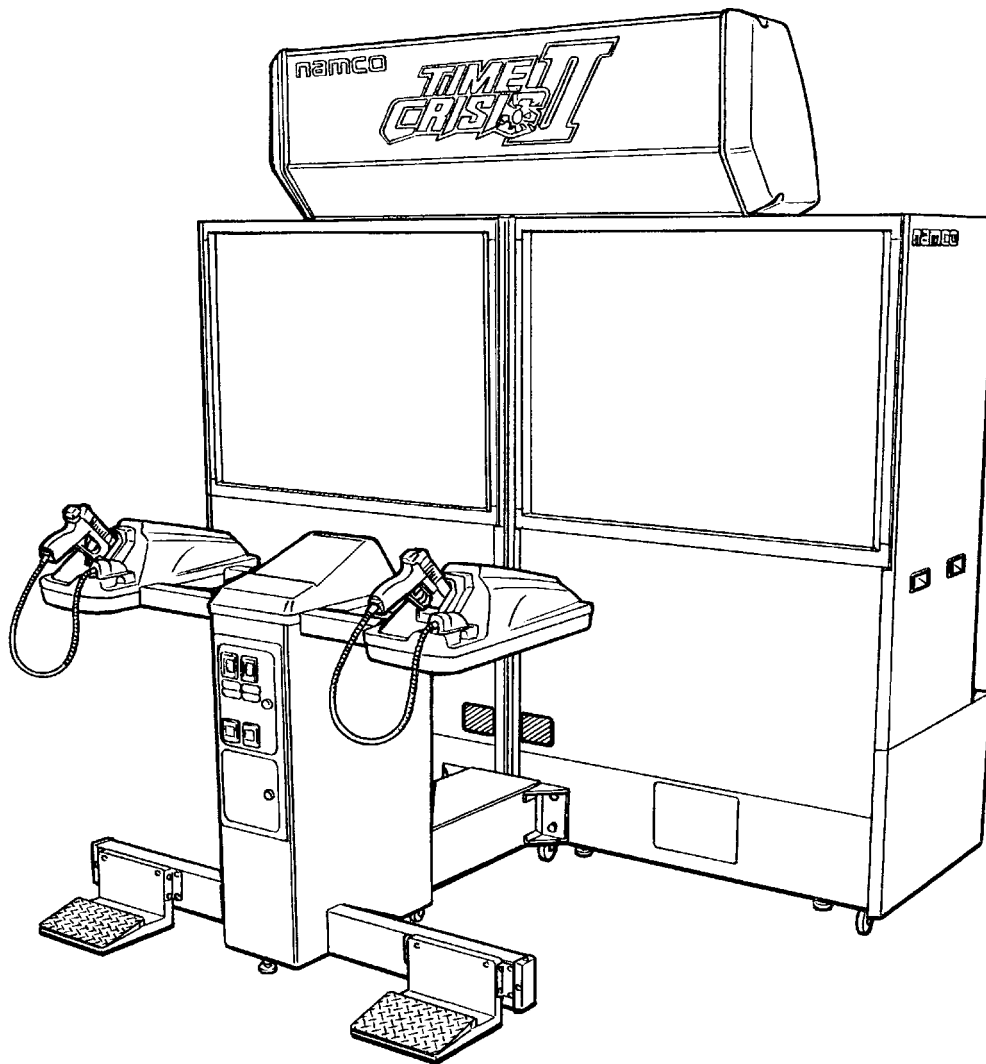

## **Operators Manual**

IT IS THE RESPONSIBILITY OF THE OPERATOR TO MAINTAIN CUSTOMER SAFETY AT ALL TIMES, AND IT IS IMPERATIVE THAT THE DETAILS SET OUT IN THIS MANUAL ARE FOLLOWED PRECISELY.



## PORTABLE APPLIANCE TESTING

### Please Note:

During testing of the machine with a portable appliance tester the insulation test will show a failure due to the fitting of two VDRs between Live/Earth and Neutral/Earth.

These components have been fitted to safeguard against high voltage surges that may occur on the mains supply to the machine and to comply with the EMC regulations.

To conduct an insulation test on this machine, the VDRs must be isolated from the circuit first.

Ensure that the VDRs are reconnected after the insulation test has been completed and before the machine is placed back into service.

The VDRs used have been specified and tested as safety critical components.



No part of this publication may be reproduced by any mechanical, photographic or electronic process, or in the form of phonographic recording, nor may it be stored in a retrieval system, transmitted or otherwise copied for private or public use, without permission from **NAMCO EUROPE LIMITED**.

While the information contained in this manual is given in good faith and was accurate at the time of printing, NAMCO EUROPE LIMITED reserve the right to make changes and alterations without notice.

This machine has been manufactured in accordance with European Community Directives, and has been tested and complies with the Directives 89/336/EEC and 72/23/EEC by the application of EN55014-1, EN55014-2, EN60335-1 and EN60335-2-82 (draft) standards (see front of manual) and as such bears the CE marking. Any changes or modifications to this machine must be in accordance with the European Directives. Any unauthorised changes to this product, may contravene such Directives.

Under some conditions of extreme external interference, e.g. radio transmissions, electrostatic discharge or mains borne transients, some degradation of performance may occur. However the machine will recover normal performance once the source of the interference has ceased or been removed.

Following abnormally high surges on the mains supply, the video monitor may need to be manually reset by turning the machine OFF and back ON.

Note:-

If the game processor resets due to an interruption or reduction of the mains voltage any credits established may be lost.

This game is not a machine as defined by the Machinery Directive 89/392/EEC

## SAFETY WARNING

In order to use this machine safely, be sure to read this Operators Manual carefully before installation, adjustment or use of this machine.

Whenever the owner of this machine entrusts dis-assembly, installation, adjustment or routine maintenance to another person, the owner should ensure that that person read the appropriate precautions and relevant sections of this manual before starting work.

**In order that no accidents occur when the machine is in operation, strictly follow the notes on safety as described below.**



This manual along with the Installation Manual (where applicable) form an integral part of the equipment and must be available to the operating and service personnel at all times.

This machine is for indoor use only and should only be used for the purpose intended.









Namco Ltd. bears no responsibility for accidents, injury or damage resulting from unauthorized changes to, or improper use of this machine.

## SAFETY NOTES

The following safety notes are used throughout this manual. Familiarize yourself with each of these notes and its meaning before installing, servicing or making adjustments to this machine.

- WARNING**  **Warning denotes a hazard that could result in injury or death. Do not proceed beyond a warning note until the indicated conditions are fully understood and met.**
- CAUTION**  Caution denotes a hazard that could result in damage to the machine. Do not proceed beyond a warning note until the indicated conditions are fully understood and met.

## GENERAL SAFETY CONSIDERATIONS

-  **Only operate this machine after checking that it has been installed correctly and in accordance with the manual.**
-  **If there is an error or problem with the machine, operation must be stopped immediately and the problem rectified before any further use.**
-  **Installation, service, adjustment or routine maintenance should be carried out by suitably qualified persons only.**
-  **For continued protection against fire hazard, replace fuses with the same type and rating. The use of other fuses or material is prohibited.**
-  **The power supply inside the monitor will remain hot and have areas of high voltage even though the machine has been turned OFF, and there is the possibility of burns or electric shock. Be careful not to touch these areas.**
-  **To prevent possible electric shock due to failure, this machine MUST be fitted with a securely connected EARTHED plug.**
-  **If at any time the mains supply lead becomes damaged, it must be replaced immediately.**
-  **Do not turn the power switch ON until the machine has been installed correctly.**
-  Before connecting the machine to the mains supply, ensure that the machine is set for the correct voltage and that the correct fuses are fitted.

## NOTES ON INSTALLATION

- ⚠ **NEVER** turn the power to the machine ON until installation has been completed.
- ⚠ In order to prevent possible electric shocks, be sure that the machine is connected to the mains with a securely connected earthed plug.
- ⚠ So that customers are not injured by the movement of the machine, ensure that there is as least 500mm separation between other machines or walls.
- ⓘ In order to avoid damage to the machine due to mis-operation, ensure that the voltage of the mains supply is 230volts AC.

Note: If the location of this machine has a polished floor, it is recommended that rubber pads are fitted under the level adjusters to prevent the machine sliding on the floor.

Note: In order to gain access to the Power Supply and CPU assemblies, make sure that the rear of the machine is separated from a wall or other machine by at least 500mm.

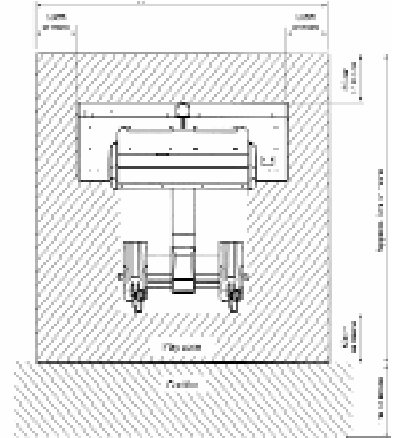

## MOVING THE MACHINE

- ⚠ This machine is fitted with castors to make it easier to move. Take care when moving the machine on an inclined surface.
- ⚠ The Header Assembly has a forward centre of gravity, so it is important that at least two people are used to fit or remove the Header Assembly.
- ⚠ The fitting position of the Header Assembly is high, and it is important that a means of reaching the height safely, without stretching, is available. (e.g. Steps, Step Stool etc.)
- ⚠ The overall height of the machine, with the Header Assembly fitted, is 2310mm. Take care of any overhead obstructions. (e.g. Light Fittings, Electric Cables etc.)
- ⚠ When moving the game, ensure that the game is dis-assembled into 3 parts: Monitor Assy, Ride Assy and Header Assy.

## REMOVING AND REPLACING PARTS

- ⚠ Adjustments or maintenance on this machine should be carried out by suitably qualified personnel only.
- ⚠ Do not make any alteration to this machine without prior approval. Doing so could cause unforeseeable danger.
- ⚠ Only parts specified by Namco Europe Ltd should be used when replacing or repairing parts. (Including screws).
- ⚠ Ensure that the power to the machine is turned OFF before commencing any maintenance work. (Trouble shooting, repairs etc.)
- ⚠ If performing work not described in this manual, be sure to contact your distributor for instructions, as no responsibility will be accepted for damage or injury.
- ⚠ Parts of the Power Supply and Monitor remain hot and carry high voltage even after switching OFF and could cause burns or electric shock. Take care not to touch these parts accidentally.
- ⚠ Make sure that the machine is switched OFF before connecting or disconnecting any plugs or connectors.
- ⚠ When removing the mains connector from the machine, or the mains plug from the wall outlet, always grasp the plug and not the cable.



Dieses Dokument darf in keiner Weise vervielfältigt werden. Jegliche Tonaufnahmen sowie die Speicherung auf Datenträger (Suchsysteme), die Weitergabe oder sonstiges Kopieren für den gewerblichen und privaten Gebrauch sind untersagt und bedürfen der vorherigen Genehmigung durch NAMCO EUROPE LIMITED.

Die Informationen in diesem Handbuch entsprechen den Tatsachen bei Drucklegung. NAMCO EUROPE LIMITED behält sich jedoch das Recht zu Änderungen ohne vorherige Bekanntgabe vor.

Dieses Gerät trägt das CE-Zeichen und wurde gemäß den EU-Richtlinien produziert. Es erfüllt die Richtlinien 89/336/EEC und 72/23/EEC und Standards EN 55014, EN55104 und EN60335-1 (s. Deckblatt des Handbuchs). Alle Veränderungen an diesem Gerät müssen in Übereinstimmung mit den EU-Richtlinien erfolgen. Nicht genehmigte Veränderungen an diesem Gerät verstoßen gegen diese Richtlinien.

Extreme äußere Störungen, wie z.B. durch Radiobetrieb, elektrostatische Entladung oder zeitweilige Netzschwankungen können zu einer Leistungsminderung führen. Sobald diese Faktoren jedoch ausgeschaltet oder beseitigt wurden, erreicht das Gerät seine normale Leistung.

Achtung! Falls der Spielprozessor auf Grund von Netzunterbrechungen oder Abnahme der Netzspannung aussetzt, kann es zum Verlust von Spielkrediten kommen.

Dieses Gerät fällt nicht unter die Maschinen-Richtlinie 89/392/EEC

## SICHERHEITSHINWEISE

Um einen ordnungsgemäßen Betrieb dieses Gerätes zu gewährleisten, muß vor Aufstellung, Inbetriebnahme und Gebrauch das Handbuch sorgfältig gelesen werden.

Sobald der Besitzer dieses Gerätes die Demontage, Aufstellung, Inbetriebnahme oder den Service einer anderen Person überträgt, muß er sicherstellen, daß diese Person vor Arbeitsbeginn die nötigen Sicherheitshinweise und die dazugehörigen Kapitel des Handbuchs liest und versteht.

Um jegliche Unfälle während des Betriebes zu vermeiden, müssen obige Hinweise strikt befolgt werden.

Dieses Handbuch sowie das spezielle Geräte-Handbuch (wenn vorhanden) gehören zum Gerät und müssen dem Betreiber und Wartungspersonal stets zugänglich sein.

Dieses Gerät ist ausschließlich für den gewerblichen Gebrauch in geschlossenen Räumen bestimmt und darf nur dort betrieben werden.

NAMCO LTD. übernimmt keinerlei Haftung für Unfälle, Verletzungen oder Beschädigungen, die auf nicht genehmigte Veränderungen oder unsachgemäßen Betrieb des Gerätes zurückzuführen sind.











## SICHERHEITSHINWEISE

Folgende Sicherheitsbegriffe werden im gesamten Handbuch benutzt. Machen Sie sich daher bitte vor Inbetriebnahme, Wartung und Durchführung von Einstellungen am Gerät mit diesen Warnhinweisen vertraut.

**WARNUNG**  **WARNUNG bezeichnet eine Gefahrenquelle für Leib und Leben. Erscheint dieser Warnhinweis, darf erst weitergearbeitet werden, wenn die entsprechenden Erklärungen vollständig verstanden und befolgt wurden.**

**VORSICHT**  **VORSICHT bezeichnet eine Gefahrenquelle für die Beschädigung des Gerätes. Erscheint dieser Warnhinweis, darf erst weitergearbeitet werden, wenn die entsprechenden Erklärungen vollständig verstanden und befolgt wurden.**

## ALLGEMEINE SICHERHEITSHINWEISE

-  **Das Gerät darf nur betrieben werden, nachdem es vorschriftsmäßig und in Übereinstimmung mit dem Handbuch aufgestellt wurde.**
-  **Die Warnschilder müssen in gutem Zustand sein und ersetzt werden, wenn sie nicht mehr gut lesbar sind.**
-  **Bei Auftreten eines Fehlers oder Problems muß das Gerät sofort abgeschaltet werden und darf erst nach fachgerechter Behebung des Fehlers wieder in Betrieb genommen werden.**
-  **Aufstellung, Service, Einstellungen und Wartung dürfen nur von dafür qualifiziertem Fachpersonal durchgeführt werden.**
-  **Zur Vermeidung von Feuer, defekte Sicherungen nur durch vorgeschriebene Sicherungen ersetzen. Die Verwendung von andersartigen Sicherungen oder unterschiedlichem Material ist untersagt.**
-  **Das Netzteil im Monitor bleibt nach Ausschalten des Gerätes noch heiß und führt weiterhin Hochspannung. Daher besteht die Gefahr von Verbrennungen und Elektroschlägen. Diese Bereiche dürfen nicht berührt werden.**
-  **Zur Vermeidung von Elektroschlägen muß dieses Gerät mit einem ordnungsgemäß geerdeten Netzstecker versehen sein.**
-  **Bei Beschädigungen des Netzteiles muß dieses umgehend ersetzt werden.**
-  **Gerät erst nach abgeschlossener Aufstellung einschalten.**
-  **Vor Einstecken des Netzsteckers bitte sicherstellen, daß Netzspannung und Gerätespannung übereinstimmen, und die vorgeschriebenen Sicherungen verwendet wurden.**

## HINWEISE ZUR AUFSTELLUNG

- ⚠ **NIEMALS** das Gerät einschalten bevor die Aufstellung völlig abgeschlossen ist.
- ⚠ Zur Vermeidung von Elektroschlägen muß das Gerät mit einem ordnungsgemäß geerdetem Netzstecker an die Stromversorgung angeschlossen werden.
- ⚠ Um zu vermeiden, daß Kunden durch die Gerätebewegungen verletzt werden, muß ein Sicherheitsabstand zu anderen Geräten und Wänden von mindestens 50cm eingehalten werden.
- ⓘ Zur Vermeidung von Beschädigungen durch Fehlbetrieb am Gerät sicherstellen, daß die Netzspannung 230 Volt beträgt.

Hinweis: Ist das Gerät für einen Aufstellplatz mit glattem Fußboden bestimmt, müssen die Standbeine mit Gummipfättchen unterlegt werden, damit das Gerät fest steht und nicht auf dem Boden hin- und herrutscht.

Hinweis: Zu Reparaturzwecken am Netzteil und den CPU-Komponenten muß die Rückseite des Gerätes mindestens 50cm von anderen Geräten und der Wand entfernt sein.

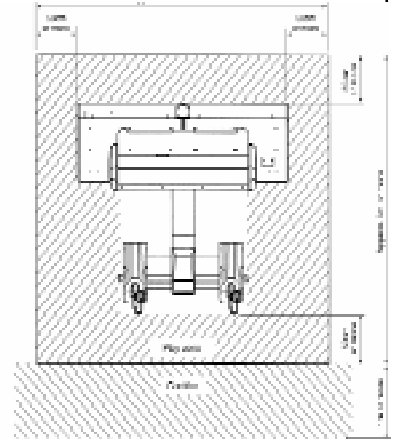

- ⚠ Zum leichteren Transport ist das Gerät mit Rollen ausgerüstet. Daher besondere Vorsicht auf abschüssigem Boden
- ⚠ Der Schwerpunkt des Aufsatzes liegt sehr weit vorn. Daher werden für den Ab- und Aufbau des Aufsatzes mindestens 2 Personen benötigt.
- ⚠ Der Aufsatz wird in großer Höhe montiert. Daher muß aus Sicherheitsgründen eine Steighilfe, wie z. B. eine Leiter, ein Tritt oder ähnliches, verwendet werden.
- ⚠ Die Gesamthöhe de Gerätes beträgt 2.31m. Daher Vorsicht bei tiefer hängenden Beleuchtungskörpern.
- ⚠ Für den Transport oder bei einem Platzwechsel Gerät in drei Teile zerlegen: Kopfteil, Vorderteil, und Fahreinheit

## AUS- UND EINBAU VON KOMPONENTEN UND TEILEN

- ⚠ **Aufstellung, Service, Einstellung und Wartung** dürfen nur von dafür qualifiziertem Fachpersonal durchgeführt werden.
- ⚠ Es dürfen keierlei Veränderungen ohne vorherige Genehmigung am Gerät vorgenommen werden. Zuwiderhandlungen stellen eine Gefahrenquelle dar.
- ⚠ Für die Repartur dürfen nur Originalersatzteile (incl. Schrauben) von NAMCO EUROPE LTD. verwendet werden.
- ⚠ Vor Beginn aller Wartungsarbeiten (Fehlersuche, Reparaturen etc.) muß der Netzstecker gezogen werden.
- ⚠ Bei Arbeiten, die nicht in diesem Handbuch beschrieben werden, muß vorher der Händler zu Rate gezogen werden, da sonst keinerlei Haftung bei Beschädigungen und Verletzungen übernommen wird.
- ⚠ Teile des Netzteiles und Bilschirmes bleiben nach Abschalten noch heiß und führen Hochspannung. Dies kann zu Verbrennungen oder einem Elektroschlag führen. Diese Teile dürfen nich berührt werden.
- ⚠ Vor der Montage oder dem Entfernen von Steckverbindungen und Steckern muß das Gerät ausgeschaltet werden.
- ⚠ Bei Ziehen des Gerätesteckers oder des Netzsteckers aus der Wandsteckdose stets den Stecker greifen und nicht das Kabel.



Denne udgivelse må ikke reproducere af nogen som helst mekanisk, fotografisk eller elektronisk proces eller i form af indspilning, den må heller ikke lagres i et eftersøgningssystem transmitteres eller kopieres til nogen form for offentlig benyttelse uden tilladelse fra **Namco Europe Limited**.

Da informationerne i denne manual er givet med god tro og var korrekt på udskivningstidspunktet, forbeholder Namco Europe Limited sig retten til, at foretage ændringer og forandringer uden varsel.

Denne maskine er frerstillet i overensstemmelse med Det Europæiske fællesskabs direktiver og er blevet testet og fuldstændt med direktiverne 89/336/EEC og 72/23/EEC standarder (se manualens forside) og som sådan bærer CE mærket. Enhver form for ændring eller modifikation af denne maskine skal være i overensstemmelse med Det Europæiske fællesskabs direktiver.

I tilfælde af forbigående ekstreme eksterne forstyrrelser, så som radio udsendelser, elektronisk afgivelse eller forstyrrelser på ledningsnettet, kan nedbrydning forekomme. Maskinen vil dog køre normalt så snart forstyrrelsen ophører eller bliver fjernet.

Bemærk:- Hvis spilleprocessoren resetter p.g.a. en forstyrrelse eller reduktion af hovedstrømmen kan de etablerede kreditter gå tabt.

Dette spil er ikke en maskine defineret af maskin direktivet 89/392/EEC -

## SIKKERHEDS ADVARSEL

For at betjene denne maskine sikkert, læs da denne brugemanual grundigt før installation, justering eller brug af maskinen.

Når som helst ejeren af denne maskine overlader demontering, installation, justeringer eller daglig vedligehold til en anden person, skal ejeren sikre sig at denne person læser de sikkerhedsregler og relevante punkter i denne manual før arbejdet begynder.

For at undgå ulykker når maskinen er i gang, følg nøje de sikkerhedsregler der er beskrevet herunder. Denne manual sammen med installations manualen er en uløselig del af udstyret og skal altid være til rådighed for det arbejdende og servicerende personale.

Denne maskine er kun til indendørs brug og bør kun bruges til det beregnede formål.

Namco Ltd. bærer intet ansvar for ulykker eller skader som er et resultat af uautoriserede ændringer eller fejlagtig brug af denne maskine.











## SIKKERHEDSREGLER

De følgende sikkerhedsregler er brugt helt igennem denne manual. Gør dig bekendt med hver enkelt af dem og meningen heraf før installation, servicering eller justering af denne maskine.

**ADVARSEL**  **Advarsel betegner en episode der kan resultere i skader eller død. Begiv dig ikke forbi et advarselsskilt før de indikerede betingelser er fuldstændig forstået.**

**FORSIGTIG**  **Forsigtig betegner en episode der kan resultere i ødelæggelse af maskinen. Begiv dig ikke forbi et advarselsskilt før de indikerede betingelser er fuldstændig forstået.**

## GENERELLE SIKKERHEDSOVERVEJELSER

-  **Betjen kun maskinen efter at have tjekket, at den er korrekt installeret og er i overensstemmelse med manualen.**
-  **Advarselsskiltene skal altid være i god stand og erstattes hvis de er slidt, så kunden tydeligt kan læse dem.**
-  **Hvis der er en fejl eller et problem med maskinen skal betjening straks stoppes, og problemet afhjælpes før yderligere brug.**
-  **Installations service, justeringer eller daglig vedligehold bør kun udføres af en kvalificeret person.**
-  **For fortsat beskyttelse mod brandfare, sikres at hoved sikringerne kun erstattes med samme type kapacitet. Brug af anden kapacitet eller materiale er forbudt.**
-  **Strømforsyningen inde i monitoren vil forblive varin og have områder med høj spænding selvom maskinen har været slukket og der er fare for brandskader eller elektrisk stød. Pas på med at røre disse områder.**
-  **For at undgå elektrisk stød p.g.a. en fejl skal denne maskine være forbundet med et sikkert jordstik.**
-  **Hvis hoved ledningerne på noget tidspunkt bliver beskadiget skal de strakt erstattes.**
-  **Tænd ikke for strømmen før maskinen er korrekt installeret.**
-  **Før tilslutning af maskinen til hovedstrømmen sikres, at maskinen er indstillet til den rette spænding.**



## PUNKTER OM INSTALLATION

- ⚠ Tænd aldrig for strømmen til maskinen før installation er fuldført.
- ⚠ For at undgå mulige elektriske stød sikres, at maskinen er forbundet til hovedstrømmen med sikkert monterede jordstik.
- ⚠ For at kunder ikke kommer til skade ved spillets bevægelser sikres, at der er mindst 50cm afstand til andre maskiner og vægge.
- ⓘ For at undgå skader på maskinen p.g.a. fejlbetjening sikres, at spændingen på hovedstrømmen er 230 volt AC.

BEMÆRK : Hvis denne maskine placeres på et poleret gulv, anbefales det at ligge gummimåtter under justeringsfødderne for at undgå at maskinen glider på gulvet.

BEMÆRK : For at få adgang til strømforsyningen og CPU justeringer sikres, at bagsiden af hoved kabinettet står adskilt fra andre maskiner eller væggen med mindst 50cm.

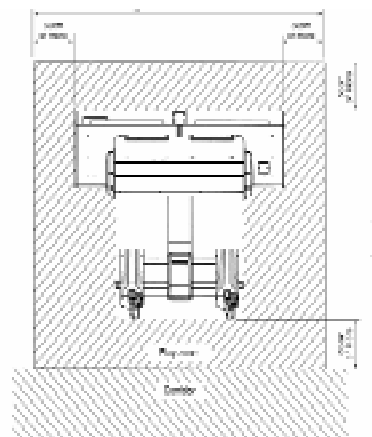

- ⚠ Maskinen er smurt med olie for at gøre den lettere bevægelig. Pas på når maskinen flyttes på en skrå overflade.
- ⚠ Hoved sektionens forreste center er meget tung, det er derfor vigtigt, at mindst 2 personer benyttes til at montere el. flytte hoved sektionen.
- ⚠ Monterins højden af hoved sektionen er meget høj og det er vigtigt, at have hjælpemidler til at nå sikkert uden at skulle strække sig. (fek.s. trapper, trappestole el. lign.).
- ⚠ Den fulde højde af hoved sektionen er 2.31 m. Pas på øvre forhindringer f.eks. lys inventar.
- ⚠ Når spillet skal flyttes eller bæres skal det sikres at den er demonteret i 3 dele: - Hoved sektion - Front sektion - Køre sektion

## AT FJERNE OG UDSKIFTE SEKTIONER OG DELE.

- ⚠ Justeringer eller vedligehold af denne maskine bør kun udføres af kvalificeret personale.
- ⚠ Skift ikke noget på maskinen uden godkendelse, det kan føre til uforudset fare.
- ⚠ Der bør kun bruges dele specificeret af Namco Europe Limited når der skiftes eller repareres dele (inklusive skruer).
- ⚠ Sørg for, at strømmen til maskinen er slukket før der foretages nogen form for arbejde (fejlfinding, reparation etc.)
- ⚠ Hvis der foretages arbejde der ikke er beskrevet i denne manual, kontakt da din leverandør for at få kyndig vejledning, da intet ansvar vil blive accepteret ved skader.
- ⚠ Dele af strømforsyningen og monitoren forbliver varme eller bærer høj spænding selv efter maskinen er slukket, det kan føre til forbrændinger eller elektriske stød. Pas på ikke at røre disse dele ved et uheld.
- ⚠ Læg mærke til at maskinen er slukket før samlinger eller stik tages ud eller sættes i.
- ⚠ Når hovedsamlingen fjernes fra maskinen eller hovedstikket fjernes fra væggen, tag da altid ved stikket, ikke ledningen.



No se permite la reproducción total ni parcial de esta publicación por ningún medio mecánico, fotográfico o electrónico, grabaciones fonográficas, ni su almacenamiento informático, su transmisión o su copia, ya sea para uso público o privado, sin permiso de NAMCO EUROPE LIMITED.

Si bien la información contenida en este manual se da de buena fe y es correcta en el momento de su impresión, NAMCO EUROPE LIMITED se reserva el derecho de hacer cambios y alteraciones sin previo aviso.

Esta máquina ha sido fabricada según las directrices de la Comunidad Europea, ha sido probada, y se ajusta a las directrices 89/336/EEC y 72/23/EEC, mediante la aplicación de los estándares EN65014, EN65104 y EN60335-1 (véase cubierta del manual) y por ende lleva el sello de la C.E. Cualquier cambio o modificación que se haga a esta máquina ha de ajustarse a las directrices de la Comunidad Europea. Cualquier cambio no autorizado hecho al producto pudiera contravenir estas directrices.

Bajo ciertas condiciones de extrema interferencia externa, p. ej. transmisiones de radio, descargas electrostáticas u oscilaciones de la red eléctrica puede tener lugar un descenso del rendimiento. No obstante, la máquina recuperará su rendimiento normal una vez que la fuente de interferencias sea retirada o cese de producirlas.

Nota: Si el procesador de juegos se reinicializa a causa de caídas o interrupciones en la alimentación eléctrica, se perderán todos los créditos.

Este juego no se ajusta a la definición de máquina de la Normativa de Maquinaria 89/392/EEC

## AVISOS DE SEGURIDAD.

Para utilizar esta máquina con seguridad, lea cuidadosamente este Manual de Operador antes de proceder a la instalación, ajuste o uso de esta máquina.

Cada vez que el propietario de esta máquina confíe a terceros su desmontaje, instalación, ajuste o mantenimiento rutinario deberá asegurarse de que tales personas lean las precauciones adecuadas y las secciones relevantes de este manual antes de comenzar su trabajo.

Para que no ocurra accidente alguno mientras la máquina se encuentre en funcionamiento, siga estrictamente las notas de seguridad tal como más adelante se describen.

Este manual, junto con el Manual de Instalación (cuando proceda), forma parte integral del equipo y debe estar a disposición del personal de mantenimiento y operación en todo momento.

Esta máquina es únicamente para ser usada en interiores, y sólo debe usarse para aquello para lo que ha sido creada. Namco Ltd. queda exenta de cualquier responsabilidad por accidentes, heridas o daños causados por cambios no autorizados o uso indebido de esta máquina.











## NOTAS DE SEGURIDAD.

En este manual se usan las notas siguientes. Familiarícese con cada una de ellas y su significado antes de instalar, revisar, o hacer ajustes en esta máquina.

**AVISO.**  **Aviso señala un riesgo que puede ocasionar lesiones o la muerte. Tras ver esta nota, no continúe hasta entender completamente y cumplir las condiciones exigidas.**

**PRECAUCIÓN.**  **Precaución señala un riesgo que puede ocasionar daños a la máquina. Tras ver esta nota, no continúe hasta entender completamente y cumplir las condiciones exigidas.**

## CONSIDERACIONES GENERALES DE SEGURIDAD.

-  **Opere sólo con esta máquina tras comprobar que ha sido instalada correctamente y de acuerdo con este manual.**
-  **Las notas de aviso deben mantenerse siempre en buen estado y reemplazarse si estuvieran desgastadas para que los usuarios puedan leerlas con claridad.**
-  **Si hubiera algún error o problema con la máquina, debe interrumpirse su operación inmediatamente, y subsanar el problema antes de volver a usarla.**
-  **Las revisiones de instalación, los ajustes, y el mantenimiento rutinario deberán llevarse a cabo sólo por personal cualificado.**
-  **Para asegurar una continua protección contra riesgo de incendios, asegúrese de que los fusibles eléctricos sean reemplazados solamente por otros del mismo tipo y especificaciones. El uso de otros fusibles o material está prohibido.**
-  **La fuente de alimentación del monitor se mantiene caliente, y tiene zonas de alto voltaje incluso cuando la máquina ha sido desconectada, existiendo el riesgo de quemaduras y descargas eléctricas. Tenga cuidado de no tocar estas zonas.**
-  **Para evitar posibles descargas eléctricas por cortes, esta máquina debe estar provista de un enchufe debidamente conectado, con TOMA DE TIERRA.**
-  **Si en cualquier momento el cable de alimentación se dañara, deberá ser reemplazado inmediatamente.**
-  **No encienda el interruptor de la máquina hasta que ésta haya sido correctamente instalada.**
-  **Antes de enchufar la máquina a la red eléctrica, asegúrese de que la máquina está preparada para el voltaje correcto, y de que se usan los fusibles adecuados.**

## NOTAS DE INSTALACIÓN.

- ⚠ **JAMÁS ENCIENDA** la máquina antes de haber completado la instalación.
- ⚠ **Para evitar posibles descargas eléctricas**, asegúrese de que la máquina está conectada a la red con un enchufe provisto de toma de tierra.
- ⚠ **Para que los usuarios no sufran lesiones debido al movimiento del juego**, asegúrese de que hay al menos 500 mm de separación entre éste y otras máquinas o las paredes.
- ⓘ Para evitar daños a la máquina causados por operación incorrecta, asegúrese de que el voltaje de la red es de 230 voltios, corriente alterna.

Notas : Si el lugar donde se instalará la máquina tiene un piso pulido, se recomienda colocar tacos de goma bajo los ajustadores de nivel para evitar que la máquina se deslice por el suelo.

Notas : Para acceder a las unidades de Fuente de Alimentación y CPU, asegúrese de que la parte trasera del mueble principal está separada de muros u otras máquinas al menos 500 mm.

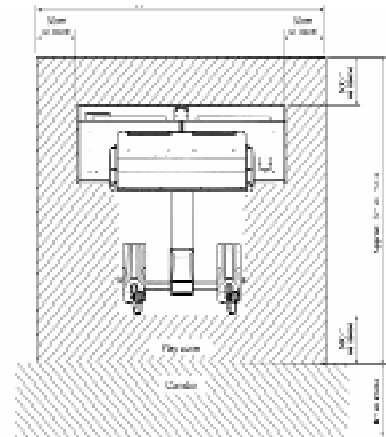

- ⚠ **El juego tiene ruedecitas para hacer más fácil su traslado. Tenga cuidado al mover la máquina en una superficie inclinada.**
- ⚠ **La Unidad de Igualación tiene el centro de gravedad desplazado hacia adelante. Es importante que su montaje y desmontaje se haga por al menos dos personas.**
- ⚠ **La posición de la Unidad de Igualación es bastante alta, y es importante que haya un medio de alcanzar su altura con seguridad, sin estirarse (p. ej. una escalera, un taburete, etc.)**
- ⚠ **La altura total de la Unidad principal es de 2.31 m. Tenga cuidado de que no haya obstáculos p. ej. luces.**
- ⚠ **Cuando traslade o mueva el juego, asegúrese de que éste haya sido desmontado en 3 partes: Unidad de Igualación, Unidad Frontal, y Unidad de Juego.**

## RETIRAR Y REEMPLAZAR PARTES Y UNIDADES.

- ⚠ **Las revisiones de instalación, los ajustes, y el mantenimiento rutinario deberán llevarse a cabo sólo por personal cualificado.**
- ⚠ **No realice alteraciones en esta máquina sin aprobación previa. De hacerlo así, pueden causar peligros imprevisibles.**
- ⚠ **Sólo deben usarse las partes especificadas por Namco Europe Ltd. para reparaciones o reemplazos (incluidos los tornillos).**
- ⚠ **Asegúrese de que la máquina está desconectada antes de comenzar cualquier trabajo de mantenimiento (reparaciones, resolución de problemas, etc.)**
- ⚠ **Al realizar trabajos no descritos en este manual, póngase en contacto con su distribuidor para recibir instrucciones. Se declina cualquier responsabilidad por daños o lesiones.**
- ⚠ **Hay partes de la fuente de alimentación y del monitor que se mantienen calientes o almacenan alto voltaje incluso tras desconectar la máquina, y pueden producir quemaduras o descargas eléctricas. Tenga cuidado de no tocar accidentalmente estas partes.**
- ⚠ **Asegúrese de que la máquina está apagada antes de conectar o desconectar cualquier enchufe o conector.**
- ⚠ **Al retirar el conector principal de la máquina, o la clavija de alimentación del enchufe de la red, agarre siempre la clavija y no el cable.**



Aucun élément de cette publication ne sera reproduit, ni par procédé mécanique, photographique ou électronique, ni par un moyen d'enregistrement phonographique. Ces informations ne seront ni stockées grâce à un procédé de récupération, ni transmises ou autrement copiées pour un usage public ou privé, sans l'autorisation de **NAMCO EUROPE LIMITED**.

Malgré le fait que les informations contenues dans ce manuel soient données de bonne foi et étaient actualisées au moment de leur impression, NAMCO EUROPE LIMITED se réserve le droit de procéder à des changements ou à des modifications sans avis préliminaire.

Ce jeu a été fabriqué en respect des normes de la Communauté Européenne, après avoir été testé il répond aux normes 89/336/EEC et 72/23/EEC, en application des standards EN55014, EN55104 et EN60335-1 (voir la couverture du manuel), et comme tel il comporte l'autocollant de conformité avec les normes de la Communauté Européenne. Tout changement non autorisé sur ce produit pourrait contrevenir à ces normes.

Sous certaines conditions extrêmes d'interférence externe, par exemple des transmissions radio, des décharges électrostatiques ou bien de interférences passagères sur le réseau, certaines dégradations ou anomalies peuvent se produire. Le jeu retrouvera cependant son état normal de fonctionnement lorsque la cause de ces anomalies aura cessé ou se trouvera déplacée.

Note:-

Si le processeur du jeu se reprogramme suite à une interruption ou une réduction de l'alimentation, les crédits qu'il aurait pu contenir peuvent se trouver perdus.

Ce jeu n'est pas une machine, telle que définie par la norme sur les machines 89/392/EEC

## MESURES DE SECURITE

Afin d'utiliser ce jeu en toute sécurité, bien lire ce manuel d'utilisation avant de procéder à son installation, son réglage ou son exploitation.

Si le propriétaire de ce jeu en confie la démontage, l'installation, le réglage ou la maintenance habituelle à une autre personne, il devra s'assurer que cette personne ait lu les conseils d'utilisation et les passages du manuel se rapportant à ce thème, avant qu'elle ne commence son travail.

Afin d'éviter tout accident pendant la durée d'exploitation de ce jeu, se conformer strictement aux conseils de sécurité décrits à la suite.

Ce manuel ainsi que le manuel d'installation du jeu (là où nécessaire) font partie des éléments nécessaires à l'installation de la machine et doivent être mis à la disposition de l'utilisateur et du personnel de maintenance à tout moment.

Ce jeu est uniquement destiné à un usage intérieur et devra être utilisé comme tel.

Namco Ltd. ne sera aucunement tenu responsable en cas d'accidents, de blessure ou de dommage quelconque résultant de modifications non autorisées ou d'usage impropre du jeu.

### REMARQUES SUR LA SECURITE

Les termes de sécurité détaillés à la suite seront utilisés tout au long de la lecture de ce manuel. Il convient de vous familiariser avec chacun de ces termes ainsi que leur signification avant de procéder à l'installation, à la maintenance ou au réglage du jeu.











**AVERTISSEMENT** 

Ce terme annonce un danger qui pourrait éventuellement avoir des conséquences dommageables ou mortelles. **Ne pas passer outre ce signal jusqu'à ce que les conditions indiquées soient entièrement comprises et effectuées.**

**ATTENTION** 

Ce terme indique qu'un danger menace la machine. **Ne pas passer outre ce signal jusqu'à ce que les conditions indiquées soient entièrement comprises et effectuées.**

### CONSIGNES GENERALES DE SECURITE

-  **Allumer l'appareil seulement après avoir vérifié qu'il a été correctement installé, et que les instructions du manuel ont été respectées.**
-  **Les notes de mise en garde doivent constamment demeurer en bon état et être remplacées en cas de disparition, afin que le client puisse les lire clairement.**
-  **S'il y a une erreur ou un problème avec la machine, l'utilisation doit être immédiatement interrompue et le problème résolu avant toute nouvelle utilisation.**
-  **L'installation, le service, le réglage, ou la maintenance doivent être effectués uniquement par les personnes qualifiées.**
-  **Afin d'éviter un éventuel incendie, s'assurer que les fusibles soient remplacés par le même type de fusibles et au bon voltage. L'utilisation d'autres sortes de fusibles ou autres matériels est interdite.**
-  **L'alimentation à l'intérieur du moniteur reste chaude et comporte des zones de haute tension même si la machine est éteinte. Il existe donc un risque de brûlure ou d'électrocution. Attention à ne pas toucher ces endroits.**
-  **Pour prévenir une éventuelle électrocution due à un défaut matériel, ce jeu DOIT être muni d'une prise de TERRE connectée en toute sécurité**
-  **Si à tout moment les fils électriques sont endommagés, il faut les remplacer immédiatement**
-  **Ne pas mettre le jeu en mode de fonctionnement avant qu'il n'ait été correctement installé.**
-  Avant de connecter la machine au réseau, s'assurer que la machine est installée sous la bonne tension et que les fusibles correspondent.

## NOTES D'INSTALLATION



**NE JAMAIS** mettre le jeu en marche avant que l'installation ne soit complètement effectuée.



Afin de prévenir une éventuelle électrocution, s'assurer que la machine est connectée au réseau avec une prise de terre reliée selon les normes de sécurité.



Afin que les clients ne soient pas blessés par les mouvements du jeu, s'assurer qu'il existe au moins 500 mm de séparation avec les autres jeux ou les murs.



Afin d'éviter que la machine ne soit abîmée suite à une mauvaise opération, s'assurer que la tension sur le réseau principal soit de 230 volts AC.

Note: Si l'endroit où doit être installée la machine à un sol poli, il est recommandé de poser des tampons feutrés sous les vérins pour éviter que le jeu ne glisse sur le sol

Note: Afin de faciliter l'accès aux CPU et à l'alimentation, s'assurer qu'il y a un espace d'au moins 500 mm entre l'arrière du meuble et le mur ou tout autre jeu.

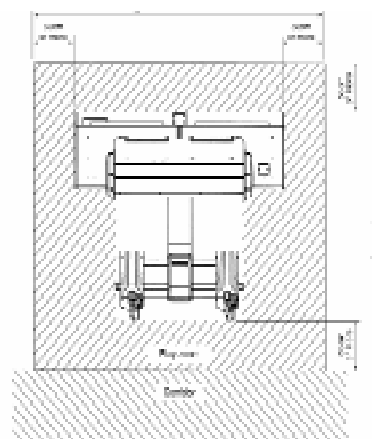

Le jeu est fourni avec des roulettes pour une meilleure mobilité. Prendre garde quand la machine est déplacée sur une surface inclinée.



Le centre de gravité de la partie supérieure du jeu est situé sur l'avant, il est donc indispensable que deux personnes au moins soient employées pour installer ou déplacer la partie supérieure.



L'installation de la partie supérieure du jeu s'effectue en hauteur, il est donc important d'utiliser un élévateur quelconque pour en effectuer le montage.



La hauteur totale de l'assemblage principal est de 2310 mm, prendre garde aux encombrements de la partie supérieure (ex : illuminations du bandeau).



Quand le jeu est déplacé ou transporté, s'assurer qu'il est séparé en 3 parties: l'assemblage du haut (le bandeau), l'assemblage de devant (la cabine), l'assemblage mobile.

## DEPLACER ET REMPLACER LES UNITES ET LES PIECES DETACHEES.



L'installation, le service, le réglage, ou la maintenance doivent être effectués uniquement par les personnes qualifiées.



Ne pas apporter de modifications sur cette machine sans autorisation préalable, faute de quoi cela pourrait entraîner un danger.



Seules les pièces détachées Namco Europe Ltd. doivent être utilisées pour le remplacement ou la réparation de pièces (y compris les vis)



S'assurer que l'interrupteur soit sur OFF avant de commencer tout travail de maintenance (localisation d'une panne, réparations, etc.)



Si dans ce manuel il manque une information pour réaliser un quelconque travail, contacter votre distributeur, car aucune responsabilité ne sera acceptée en cas de dommage ou de blessure.



Les pièces de l'alimentation et du moniteur restent chaudes, à tension élevée même lorsque la machine est hors tension, elle pourrait occasionner des brûlures ou des électrocutions. Attention de ne pas toucher ces endroits accidentellement.



S'assurer que la machine soit hors tension avant de brancher ou débrancher toute prise ou connecteur.



Lorsque l'on manipule la prise au réseau de la machine, ou lorsque les prises principales doivent être débranchées, saisir toujours la prise, et non le câble.



Κανένα μέρος αυτής της έκδοσης δεν μπορεί να αναπαραχθεί με οποιοδήποτε μηχανικό ,φωτογραφικό ή ηλεκτρονικό μέσο , ή με μορφή φωνητικής ηχογράφησης και ούτε να αποθηκευτεί με επανορθωτικό σύστημα , να μεταδοθεί ή να αντιγραφεί για δημόσια ή ιδιωτική χρήση , χωρίς την άδεια της NAMCO EUROPE LIMITED.

Καθώς αυτές οι πληροφορίες σε αυτό το εγχειρίδιο έχουν δοθεί με καλή πίστη και ακριβώς την ώρα της τύπωσης , η εταιρεία NAMCO EUROPE LIMITED κρατάει το δικαίωμα να κάνει οποιεσδήποτε αλλαγές χωρίς ειδοποίηση.

Τα μηχανήματα έχουν κατασκευαστεί σύμφωνα με τους όρους της Ευρωπαϊκής Κοινότητας , και έχουν ελεγχθεί σύμφωνα με τους νόμους 89/336/EOK και 72/23/EOK με την αίτηση των EN55014 , EN55104 και EN60335-1 στάνταρτς (δες μπροστά στο εγχειρίδιο) και όλα έχουν το CE σήμα . Οποιαδήποτε αλλαγή ή μετατροπή σε αυτό το μηχάνημα πρέπει να είναι σύμφωνα με τους όρους της Ευρωπαϊκής Κοινότητας. Οποιοσδήποτε αλλαγές χωρίς άδεια σε αυτό το προϊόν μπορεί να παραβεί αυτούς τους όρους.

Σε κάποιες περιπτώσεις υπερβολικής εξωτερικής παρεμβολής ,π.χ. ραδιοφωνικές μεταδόσεις , ηλεκτροστατικές μεταβολές ή παροδικές εμβολές , μπορεί να παρουσιαστούν κάποιες αθλιότητες στην παρουσίαση . Πάντως το μηχάνημα θα επανέλθει στην φυσιολογική παρουσίαση εφ όσον η πηγή της παρεμβολής σταματήσει ή απομακρυνθεί .

Σημείωση : Εάν γίνει reset στον processor του μηχανήματος κατά τη διάρκεια της κύριας παροχής , πόντοι που έχουν κερδηθεί μπορεί να χαθούν.

Αυτό το παιχνίδι δεν είναι μηχάνημα όπως προσδιορίζεται από τους όρους Μηχανημάτων 89/392/EOK .

## ΟΔΗΓΙΕΣ ΑΣΦΑΛΕΙΑΣ

Για την ασφαλή χρήση του μηχανήματος , πρέπει να διαβάσεις το εγχειρίδιο χρήσης προσεκτικά πριν την εγκατάσταση ,τοποθέτηση ή χρήση του μηχανήματος.

Οποιοδήποτε ο ιδιοκτήτης αυτού του μηχανήματος ζητάει από κάποιο πρόσωπο να εγκαταστήσει , να κάνει οποιαδήποτε αλλαγή ή έλεγχο ρουτίνας στο μηχάνημα , πρέπει να είναι σίγουρος ότι έχει διαβάσει τις οδηγίες αυτού του εγχειριδίου πριν να αρχίσει να δουλεύει .

Προς αποφυγήν οποιουδήποτε ατυχήματος κατά την λειτουργία του μηχανήματος , αυστηρώς ακολουθούνται οι οδηγίες ασφάλειας όπως δίνονται παρακάτω .

Αυτό το εγχειρίδιο σε συνδυασμό με το εγχειρίδιο εγκατάστασης (όπου διατίθεται) αποτελεί ένα ολοκληρωμένο μέρος των παροχών και πρέπει να είναι διαθέσιμο για την λειτουργία και το service οποιαδήποτε στιγμή.

Αυτό το μηχάνημα είναι για χρήση μόνο σε εσωτερικό χώρο και θα πρέπει να χρησιμοποιείται μόνο για τους λόγους για τους οποίους κατασκευάστηκε.

Η εταιρεία NAMCO Ltd δεν φέρει καμία ευθύνη για ατυχήματα , πληγές ή καταστροφές που μπορεί να προκληθούν από αλλαγές χωρίς άδεια σε ή εισαγωγές αυτού του μηχανήματος.











## ΣΗΜΕΙΩΣΕΙΣ ΑΣΦΑΛΕΙΑΣ

Οι ακόλουθες σημειώσεις ασφάλειας χρησιμοποιούνται μέσω αυτού του εγχειριδίου . Διάβασε αυτές προσεκτικά για να γίνει κατανοητό το νόημά τους πριν την εγκατάσταση , σέρβις ή οποιαδήποτε αλλαγή γίνεται στο μηχάνημα.

**ΠΡΟΕΙΔΟΠΟΙΗΣΗ**  Η προειδοποίηση αφορά κίνδυνο ο οποίος μπορεί να είναι λόγος θανάτου . Να μην προχωρήσεις σε οποιαδήποτε κίνηση μέχρι αυτοί οι όροι γίνουν κατανοητοί.

**ΠΡΟΣΟΧΗ**  Η προσοχή αφορά κίνδυνο ο οποίος μπορεί να προκαλέσει πρόβλημα στο μηχάνημα . Να μην προχωρήσεις σε οποιαδήποτε κίνηση μέχρι αυτοί οι όροι γίνουν κατανοητοί.

## ΕΞΕΤΑΣΗ ΓΕΝΙΚΗΣ ΑΣΦΑΛΕΙΑΣ

-  Αφού έχει κατανοηθεί αυτό το εγχειρίδιο , μόνο τότε να λειτουργήσει το μηχάνημα ή να γίνει έλεγχος εφ όσον έχει γίνει η εγκατάσταση.
-  Οι προειδοποιήσεις πρέπει να μένουν καθαρές και σε καλή κατάσταση ώστε ο πελάτης να τις διαβάζει καθαρά.
-  Εάν υπάρχει λάθος ή πρόβλημα με το μηχάνημα , η λειτουργία πρέπει να σταματάει αμέσως και να διορθώνεται το λάθος πριν οποιαδήποτε άλλη χρήση.
-  Εγκατάσταση , μετατροπή ή έλεγχος ρουτίνας μπορεί να γίνεται μόνο από εξουσιοδοτημένα άτομα .
-  Για συνεχή προστασία από φωτιά , πρέπει οι ασφάλειες να αντικαθιστούνται με ίδιου τύπου .Η χρήση άλλων ασφαλειών ή αντικειμένων απαγορεύεται.
-  Το τροφοδοτικό στο εσωτερικό του μηχανήματος θα παραμείνει ζεστό και υπάρχουν περιοχές με υψηλή τάση παρ'όλο που το μηχάνημα δεν δουλεύει , και υπάρχει η πιθανότητα ηλεκτρικού σοκ . Προσοχή να μην ακουμπήσεις αυτές τις περιοχές.
-  Για την αποφυγή ηλεκτρικών σοκ λόγω βλάβης , το μηχάνημα ΠΡΕΠΕΙ να έχει πρώτα ενωθεί με γείωση.
-  Εάν κάποια στιγμή καταστραφεί η κύρια παροχή , πρέπει να αντικατασταθεί αμέσως.
-  Να μην ανάψει το μηχάνημα (switch ON) μέχρι να έχει εγκατασταθεί σωστά και πλήρως.
-  Πριν την παροχή ρεύματος στο μηχάνημα , να είσαι σίγουρος ότι τα voltage και όλες οι ασφάλειες είναι σωστά ενωμένα και τοποθετημένα.

## ΣΗΜΕΙΩΣΕΙΣ ΓΙΑ ΤΗΝ ΕΓΚΑΤΑΣΤΑΣΗ

- ⚠ **ΠΟΤΕ να μην ανάβει το μηχάνημα εάν δεν έχει ολοκληρωθεί η εγκατάσταση.**
- ⚠ **Για την αποφυγή ηλεκτρικών σοκ πρέπει το μηχάνημα να έχει γειωθεί.**
- ⚠ **Για την αποφυγή κινδύνου σε κάποιον παίκτη , πρέπει το μηχάνημα να έχει απόσταση τουλάχιστον 500mm από άλλο μηχάνημα ή τοίχο.**
- ⓘ **Για την αποφυγή βλάβης στο μηχάνημα λόγω λάθος λειτουργίας , πρέπει η παροχή να είναι 230volt AC..**

**ΣΗΜΕΙΩΣΗ:** Εάν το πάτωμα στο οποίο είναι τοποθετημένο το μηχάνημα γλιστράει, είναι καλό να μπει ένα κομμάτι μοκέτας για αποφυγή μετακίνησης του μηχανήματος εν ώρα λειτουργίας του.

**ΣΗΜΕΙΩΣΗ:** Για την εύκολη πρόσβαση στην κυρίως παροχή ή το CPU πρέπει η πίσω πόρτα του μηχανήματος να απέχει τουλάχιστον 500mm από τον τοίχο ή άλλο μηχάνημα.

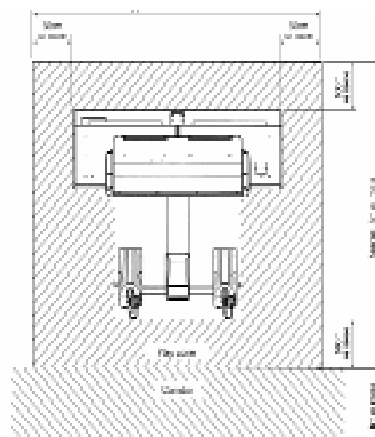

- ⚠ **Το μηχάνημα είναι εφοδιασμένο με καρούλια για την εύκολη μετακίνησή του.**
- ⚠ **Το επάνω μέρος του μηχανήματος έχει επιπλέον βάρος γιατί χρειάζονται δύο για την μεταφορά.**
- ⚠ **Η κεφαλή (καπάκι) του μηχανήματος είναι πολύ ψηλή και γιατί χρειάζεται προσοχή στην τοποθέτησή του , να μην χτυπήσει ή καταστραφεί.**
- ⚠ **Το συνολικό ύψος της κεφαλής είναι 2310mm . Φρόντισε να μην χτυπήσει σε λάμπες κ.λ.π.**
- ⚠ **Όταν μετακινείται το μηχάνημα , πρέπει να είναι σε 3 μέρη : Κεφαλή (καπάκι), Μπροστά μέρος (οθόνες), Κάθισμα**

## ΑΠΟΜΑΚΡΥΝΣΗ ΚΑΙ ΑΝΤΙΚΑΤΑΣΤΑΣΗ ΜΕΡΩΝ - ΑΝΤΑΛΛΑΚΤΙΚΩΝ

- ⚠ **Εγκατάσταση , μετατροπή ή έλεγχος ρουτίνας μπορεί να γίνεται μόνο από εξουσιοδοτημένα άτομα .**
- ⚠ **Δεν πρέπει να γίνονται μετατροπές στα μηχανήματα χωρίς έγκριση . Μπορεί να προκληθεί απρόβλεπτος κίνδυνος.**
- ⚠ **Μόνο μέρη που διευκρινίζονται από την εταιρεία NAMCO EUROPE Ltd μπορούν να χρησιμοποιηθούν για αντικατάσταση ή επιδιόρθωση. (συμπεριλαμβάνονται και οι βίδες)**
- ⚠ **Να είναι σίγουρα κλειστό το ρεύμα πριν οποιαδήποτε δουλειά στο μηχάνημα.**
- ⚠ **Εάν γίνει κάποια δουλειά στο μηχάνημα χωρίς να διευκρινίζεται στο εγχειρίδιο , να επικοινωνήσεις με τον αντιπρόσωπο για οδηγίες γιατί καμία ευθύνη δεν φέρουμε για καταστροφές ή βλάβες.**
- ⚠ **Μέρη του τροφοδοτικού ή του μόνιτορ παραμένουν ζεστά ή έχουν υψηλή τάση ακόμα και όταν σβήσει το μηχάνημα και μπορούν να προκαλέσουν κάψιμο ή ηλεκτροσόκ. Γιαυτό δεν πρέπει να έρχονται σε επαφή με χέρια .**
- ⚠ **Το μηχάνημα πρέπει να είναι σβηστό κατά την σύνδεση ή αποσύνδεση πρίζας ή κονέκτορα.**
- ⚠ **Κατά την απομάκρυνση των κεντρικών κονέκτορ από το μηχάνημα ή της κυρίας πρίζας , πρέπει να πιάνουμε το πλαστικό μέρος και όχι το καλώδιο.**



Nessuna parte di questa pubblicazione può essere riprodotta con processo meccanico, fotografico o elettronico, nè sotto forma di registrazione fonografica, nè può essere memorizzata in un sistema di salvataggio, trasmessa o in altro modo copiata per uso pubblico o privato, senza l'autorizzazione di **NAMCO EUROPE LIMITED**.

Le informazioni contenute in questo manuale sono state date in buona fede ed erano accurate al momento della pubblicazione. Tuttavia NAMCO EUROPE LIMITED, si riserva il diritto di apporre cambiamenti e variazioni senza alcun preavviso.

Questo apparecchio è stato costruito in conformità alle Direttive della Comunità Europea, ed è stato provato e soddisfa le Direttive 89/336/EEC e 72/23/EEC per l'applicazione degli standards delle norme EN55014, EN55104 e EN60335-1 (vedi fronte del manuale), e per questo porta il marchio CE. Qualsiasi cambiamento o modifica di questo apparecchio deve essere in conformità con le Direttive della Comunità Europea.

In caso di condizioni di estrema interferenza dall'esterno, per esempio trasmissioni radio, scariche elettrostatiche o transistori sulla linea, può verificarsi un decadimento delle prestazioni. Comunque l'apparecchio ritornerà al rendimento normale quando la sorgente dell'interferenza avrà cessato di emettere o sarà stata rimossa.

Nota bene: se il processore del gioco "resetta" a causa di una interruzione o diminuzione del voltaggio di linea, un eventuale credito, già concesso, può essere annullato.

Questo gioco non è una macchina così come viene definita dalla Direttiva Macchine 89/392/EEC.

## AVVERTENZE PER LA SICUREZZA

Allo scopo di usare questo apparecchio in sicurezza, leggere questo Manuale dell'operatore attentamente prima dell'installazione, regolazione o uso di questa macchina.

Tutte le volte che il proprietario di questo apparecchio affida lo smontaggio, l'installazione, la regolazione o la manutenzione ordinaria ad un'altra persona, il proprietario stesso deve assicurarsi che quella persona legga le precauzioni necessarie e i paragrafi importanti di questo manuale prima di iniziare a lavorare.

**Perchè non succeda alcun incidente quando la macchina è operante, seguire rigorosamente le note sulla sicurezza come specificato più avanti.**

Questo manuale insieme con il manuale di installazione (dove si può applicare) forma una parte integrante dell'apparecchio e deve essere disponibile sempre al personale operante e di servizio.

Questa macchina deve essere usata solo in interni e deve essere usata solo per gli scopi per cui è progettata.

Namco Europe Ltd non si assume responsabilità per incidenti, ferite o danni risultanti da cambiamenti non autorizzati o da uso improprio della macchina.

## NOTE PER LA SICUREZZA

Le seguenti note sulla sicurezza sono usate dal principio alla fine di questo manuale. Valutare attentamente ciascuna di queste note ed il loro significato prima di installare, fare assistenza o regolazioni su questa macchina.

**WARNING** ⚠ "Warning" evidenzia un rischio di ferita o di morte. Non procedere oltre una nota "Warning" finchè le avvertenze specificate non siano completamente capite e conosciute.

**CAUTION** ⚠ "Caution" evidenzia un rischio di danneggiare la macchina. Non procedere oltre una nota "Caution" finchè le avvertenze specificate non siano completamente capite e conosciute.

## CONSIDERAZIONI GENERALI SULLA SICUREZZA

- ⚠ **Mettere in funzione l'apparecchio solo dopo aver controllato che l'installazione sia stata effettuata correttamente ed in conformità alle istruzioni del manuale.**
- ⚠ **Gli avvisi "Warning" devono sempre essere conservati in buone condizioni e sostituiti se consumati, cosicchè il cliente li possa leggere chiaramente.**
- ⚠ **Se vi sono errori o problemi con la macchina, si deve interrompere il funzionamento immediatamente e risolvere il problema prima di ogni ulteriore uso.**
- ⚠ **L'installazione, l'assistenza, le regolazioni e la manutenzione ordinaria devono essere eseguite solo da persone idonee e qualificate.**
- ⚠ **Per una protezione costante contro il rischio di fuoco, assicurarsi che i fusibili sulle alimentazioni siano solo sostituiti con lo stesso tipo e caratteristiche. L'uso di altri fusibili o materiali è proibito.**
- ⚠ **L'alimentatore all'interno del monitor rimane caldo ed ha zone di alto voltaggio anche se la macchina è stata spenta, c'è quindi la possibilità di bruciate o scosse elettriche. Fare attenzione a non toccare queste zone.**
- ⚠ **Per prevenire possibili scosse elettriche dovute a difetti, questa macchina DEVE essere installata con un connettore sicuramente MESSO A TERRA.**
- ⚠ **In caso il cavo di alimentazione di rete risultasse danneggiato deve essere sostituito immediatamente.**
- ⚠ **Non accendere la macchina finchè la stessa non è stata installata completamente e correttamente.**
- ⚠ **Prima di collegare la macchina alla rete, assicurarsi che la macchina sia preparata per il voltaggio corretto e che siano inseriti i fusibili adatti.**



## NOTES D'INSTALLATION

 **NON ACCENDERE MAI** la macchina finchè l'installazione non è stata completata.

 **Allo scopo di prevenire possibili scosse elettriche, la macchina deve essere obbligatoriamente collegata alla rete con un connettore messo a terra con connessioni sicure.**

 **Perchè i clienti non siano feriti dal movimento del gioco, assicurarsi che ci siano almeno 500mm di distanza rispetto alle altre macchine o rispetto al muro.**

 Per evitare danni alla macchina durante la messa in opera, assicurarsi che il voltaggio della rete sia 230 volts AC.

Note: Il luogo di destinazione della macchina deve avere il pavimento liscio e si raccomanda di sistemare dei cuscinetti di gomma sotto i piedini di livellamento per prevenire lo scivolamento della macchina sul pavimento.

Note: Per garantire l'accesso all'alimentatore e alla scheda madre, assicurarsi che il retro del mobile principale sia separato dalla parete o da altre macchine di almeno 500mm.

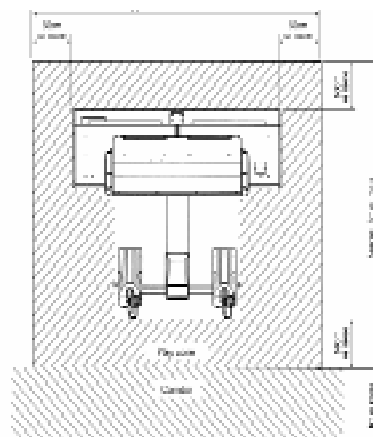

 **Il gioco è fornito di ruote per rendere più facile il suo spostamento. Fare attenzione quando si muove la macchina su una superficie inclinata.**

 **La testata ha il baricentro spostato in avanti, è perciò importante che ci siano almeno 2 persone per montare o smontare la testata stessa.**

 **La posizione di fissaggio della testata è molto alta, ed è importante che ci sia un mezzo disponibile per raggiungere tale altezza in sicurezza e senza allungamenti. (Ad esempio scalini, scale portatili etc.)**

 **L'altezza totale della parte principale è 2310mm, fare attenzione ad eventuali ostacoli sopra la testata ovvero ad eventuali installazioni di luci.**

 **Quando si muove o si trasporta il gioco assicurarsi che sia smantato in 3 parti: Testata, Parte frontale, Parte mobile**

## RIMOZIONE E SOSTITUZIONE DI GRUPPI E PARTI STACCATE

 **L'installazione, l'assistenza, le regolazioni e la manutenzione ordinaria devono essere eseguite solo da persone idonee e qualificate.**

 **Non apporre alcuna modifica alla macchina senza autorizzazione preventiva. Il fare questo può causare un pericolo non prevedibile.**

 **Quando si rimpiazza o si riparano delle parti (incluse le viti) si possono usare solo parti approvate dalla Namco Europe Ltd.**

 **Assicurarsi che la macchina sia SPENTA prima di incominciare qualsiasi lavoro di manutenzione (guasti, riparazioni etc.)**

 **Se state per iniziare un lavoro non descritto in questo manuale, contattate il vostro distributore per istruzioni poichè non si accetta alcuna responsabilità per danni o ferite.**

 **Parti dell'alimentatore e del monitor rimangono caldi o portano alta tensione anche dopo aver spento l'apparecchiatura e possono causare bruciate o scosse elettriche. Attenzione a non toccare queste parti accidentalmente.**

 **Assicurarsi che la macchina abbia l'interruttore nella posizione OFF prima di inserire o disinserire qualsiasi connettore o spina.**

 **Quando vengono rimossi i connettori principali dalla macchina oppure la spina dell'alimentazione dalla parete bisogna sempre afferrare il connettore e non il cavo.**



Ingen del av denne utgivelsen må reproduseres av noen mekaniske, fotografiske eller elektroniske prosesser, eller i form av fotografiske opptak, og ikke kan det lagres i et gjenvinnbart system, sendt eller kopiert for offentlig eller privat bruk, uten tillatelse fra NAMCO EUROPE LIMITED.

Da informasjonen i denne manualen er gitt i god tru og var korrekt da den ble utgitt, tillegger NAMCO EUROPE LIMITED seg retten til å lage forandringer uten varsel.

Denne maskinen er produsert i samsvar med direktiver framsatt av det Europeiske samfunn. Maskinen er testet og samsvarer med direktivene 89/336/EEC og 72/23/EEC med anvendelse av EN55014, EN55104 og EN60335-1 standarder (se i begynnelsen av manualen), og derfor bærer CE merket. Hvilken som helst forandring eller modifisering må skje etter direktivene satt av det Europeiske samfunn. Uautoriserte forandringer på dette produktet, kan motstride disse direktivene.

Under noen forhold av ekstreme ytre forstyrrelser, f.eks radio sendere, elektronisk utladning eller transiente spenninger, kan man regne med noe senket ytelse. Men maskinen vil oppnå normal ytelse når kilden til forstyrrelsene opphører eller er fysisk fjernet.

Merk:- Hvis spilllets prosessor resettes p.g.a et kutt eller reduksjon av hovedspenningen kan oppsparte kreditt på spillet forsvinne.

Dette spillet er ikke en maskin som er definert ved Maskin direktivet 89/392/EEC.

### Sikkerhets advarsel.

For å bruke denne maskinen uten noe form for fare, sørg for å lese denne manualen nøye før installasjon, justeringer eller bruk av maskinen.

Når eieren av denne maskinen overlater avmontering, installasjon, justering eller rutine vedlikehold til en annen person, skal eieren forsikre seg om at denne personen leser de passende forsiktighetsreglene og relevante deler av manualen før han starter på arbeidet.

For å forhindre at ulykker inntreffer når maskinen er i drift, følg strengt teksten om sikkerhet som beskrevet nedenfor.

Denne manualen sammen med installasjons manualen (hvor det er anvendelig) er en intrigert del av utstyret og må være tilgjengelig for drift- og servispersonell til alle tider.

Denne maskinen er bare for innendørs bruk og skal bare benyttes etter mente hensikter.

Namco Ltd. bærer intet ansvar ved ulykker, kvestelse eller skade som følger av uautoriserte forandringer, eller for uriktig bruk av maskinen.











### Sikkerhets beskjeder.

Følgende sikkerhets punkter er brukt ut denne manualen. Gjør deg kjent med disse punktene og deres mening før installasjon, service eller du utfører noen innstillinger på denne maskinen.





**ADVARSEL**  **Advarsel innebærer en risiko som kan føre til kvestelse eller død. Ikke fortsett utover advarslen før den er ordentlig forstått og motiltak er igangsatt.**

**FORSIKTIG**  Forsiktig innebærer en risiko som kan medføre skade på maskinen. Ikke fortsett utover advarslen før den er ordentlig forstått og motiltak er igangsatt.

### VANLIGE SIKKERHETSTILTAK

-  **Bruk bare denne maskinen etter å ha kontrollert at den er korrekt installert ifølge manualen.**
-  **Advarsel skiltene må bestandig holdes i skikket stand og eventuelt byttes ut hvis det oppstår skade på dem, slik at kunden uten vanskelighet kan lese dem.**
-  **Hvis det er en feil eller et problem med maskinen, må den straks settes ut av funksjon. Og må under ingen omstendigheter startes før problemet er rettet på.**
-  **Installasjon, service, justering eller rutine vedlikehold skal bare utføres av kvalifiserte personer.**
-  **For fortsatt beskyttelse mot brann, forsikre deg at hoved sikringen bare byttes ut med en av samme type og verdi. Bruk av andre sikringer eller materiale er forbudt.**
-  **Strømforsyningen inne i monitoren vill være varm og ha områder med høy spenning selv om maskinen har blitt slått av. og det er muligheter for skader og elektriske sjokk. Vær forsiktig så du ikke berører disse områdene.**
-  **For å forhindre mulige elektriske sjokk grunnet funksjonsfeil, må denne maskinen være ordentlig jordnet.**
-  **Hvis ledningen til hoved strømforsyningen skades må den straks byttes ut.**
-  **Ikke slå på maskinen før den er korrekt installert.**
-  **Før du kopler maskinen til strømmettet, forsikre deg om at maskinen innstilt for den korrekte spenningen og de riktige sikringene benyttes.**





## MERKNADER VED INSTALLASJON

-  Slå **ALDRI** på maskinens strømforsyning før installasjonen er fullført.
-  For å forhindre eventuelle elektriske sjokk, forsikre deg om at maskinen er koplet til et strømnnett med ordentlig jording.
-  For å forhindre at kundene blir skadet av spilllets bevegelige deler, forsikre deg om at det er minst 500mm avstand mellom andre maskiner eller vegger.
-  For å forhindre skade på maskinen p.g.a. feil bruk, sørg for at spenningen til hoved strømforsyningen er 230Volt AC.

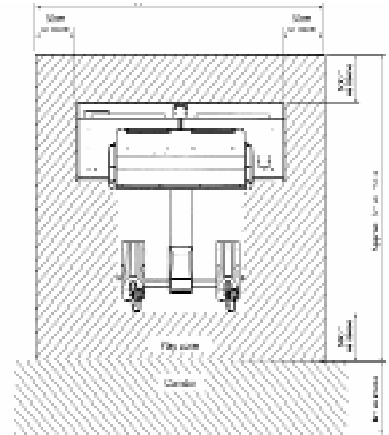







MERKNADER: Hvis plassen hvor spillet skal plasseres har polerte gulv anbefales det at du benytter gummi sko under nivå justeringene, for å forhindre at maskinen kan flytte på seg.

MERKNADER: For å få adgang til strømforsyningen og CPU-kort, forsikre deg om at bakparten av hoved kabinettet er skilt fra vegger eller andre maskiner med minst 500mm.



-  Spillet har montert hjul for å gjøre det lettere å flytte på. Hver forsiktig når det skal flyttes på en hellende overflate.
-  Hoved enheten i spillet har tyngdepunktet i fronten, så det er viktig at minst 2 personer blir brukt til å montere eller flytte denne enheten.
-  Monterings posisjonen til hoved enheten er veldig høy, og det er viktig at denne høyden nås sikkert, uten at man må strekke seg. Benytt deg av hjelpemiddel. (f.eks sto, krakk, gardintrapp osv)
-  Den totale høyden på hoved enheten er 2310mm. vær forsiktig med høye hindringer som f.eks lysrør.
-  Når spillet skal flyttes, forsikre deg om at spillet er delt i 3 deler: Topp enhet, Front enhet, Hoved enhe

## FJERNE OG UTSKIFTE ENHETER OG DELER.

-  Installasjon, service, justering eller rutine vedlikehold skal bare utføres av kvalifiserte personer.
-  Ikke lag noen forandringer på denne maskinen uten godkjenning. Dette kan medføre uforutsette farer.
-  Bare deler spesifisert av Namco Europe Ltd. skal benyttes ved utskifting eller reparasjon av deler (dette gjelder også skruer).
-  Forsikre deg om at strømmen er slått av før du påbegynner noe som helst vedlikeholdsarbeid (feilsøking, reparasjon osv.)
-  Hvis du utfører arbeid som ikke er beskrevet i denne manualen, ta kontakt med din distributør for instruksjon da ikke noe ansvar vill bli akseptert for skade på maskin eller på personer.
-  Deler av strømforsyningen og monitoren er fortsatt varm eller bærer høye spenninger selv etter strømmen er slått av og kan forårsake skader eller elektriske sjokk. Forsikre deg om at du ikke berører disse delene.
-  Forsikre deg om at maskinen er slått av før du kople sammen eller tar fra hverandre plugger eller koblinger.
-  Når du fjerner hoved koblignene fra maskinen, eller hoved pluggen fra støpselet, ta bestandig tak i pluggen og ikke ledningen.



Niets uit deze publikatie mag worden gereproduceerd door enig mechanisch, fotografisch of elektronisch proces, of in de vorm van een fonografische opname, noch mag het opgeslagen worden in een retrieval systeem, doorgezonden of anderszins gekopieerd voor publiek of privégebruik, zonder toestemming van Namco Europe Limited.

Ofschoon de informatie in deze handleiding in goed vertrouwen is gegeven en nauwkeurig was ten tijde van het drukken, houdt Namco zich het recht voor om veranderingen en aanpassingen te maken zonder bericht.

Deze machine is geproduceerd volgens Richtlijnen van de Europese Gemeenschap, en is getest en is in overeenstemming met de Richtlijnen 89/336/EEC en 72/23/EEC door de toepassing van de standaards EN55014, EN55104 en EN60335-1 (zie voorin de handleiding) en draagt als zodanig het CE-merk. Enige veranderingen of aanpassingen aan deze machine dienen in overeenstemming te zijn met de Richtlijnen van de Europese Gemeenschap. Enige ongeauthoriseerde veranderingen aan dit produkt kunnen in strijd zijn met deze Richtlijnen.

Onder sommige omstandigheden van extreme externe storingen, bijv. radiotransmissies, electrostatische ontladingen of pieken op het net, kan prestatieruggang optreden. De machine zal echter normaal presteren zodra de storingsbron gestopt of verwijderd is.

Let op: - als de spelprocessor reset a.g.v. een onderbreking of vermindering van de netstroom, dan kunnen opgebouwde credits verloren gaan.

Dit spel is niet een machine zoals omschreven in de Machinery Directive 89/392/EEC.

### Veiligheidsopmerkingen

Om deze machine veilig te kunnen gebruiken, dient vóór installatie, aanpassing of gebruik van deze machine, de Bedieningshandleiding zorgvuldig gelezen te worden.

Telkens wanneer de eigenaar van deze machine de demontage, installatie, aanpassing of routine-onderhoud toevertrouwd aan een andere persoon, dient de eigenaar er voor te zorgen dat deze persoon de juiste voorzorgsmaatregelen en relevante gedeeltes uit de handleiding leest voordat hij begint.

Om er voor te zorgen dat geen ongelukken gebeuren als de machine gebruikt wordt, dienen onderstaande veiligheidsaanwijzingen zorgvuldig opgevolgd te worden.

Deze handleiding maakt samen met de installatiehandleiding (waar van toepassing) een integraal deel uit van de apparatuur en moet te allen tijde ter beschikking staan van exploitatie- en onderhoudspersoneel.

Deze machine is alleen bedoeld voor gebruik binnenshuis en dient alleen gebruikt te worden voor bedoelde doeleinden.

Namco Ltd. is niet verantwoordelijk voor ongelukken, letsel of schade die voortkomt uit ongeoorloofde veranderingen aan of onjuist gebruik van deze machine.











### Veiligheidsopmerkingen

De volgende veiligheidsopmerkingen worden overal in deze handleiding gebruikt. Maak uzelf vertrouwd met deze opmerkingen en hun betekenis vóór installatie, het plegen van onderhoud of het aanbrengen van aanpassingen aan deze machine.

**WAARSCHUWING**  **Waarschuwing geeft een gevaar aan dat zou kunnen resulteren in letsel of de dood. Ga niet verder dan een waarschuwingsofmerking totdat de aangegeven omstandigheden volledig begrepen zijn en hieraan voldaan is.**

**VOORZICHTIG**  **Voorzichtig geeft een gevaar aan dat zou kunnen resulteren in schade aan de machine. Ga niet verder dan een voorzichtigheidsopmerking totdat de aangegeven omstandigheden volledig begrepen zijn en hieraan voldaan is**

### ALGEMENE VEILIGHEIDSOVERWEGINGEN

-  **Stel deze machine alleen in gebruik nadat gecontroleerd is of de machine correct en overeenkomstig de handleiding is geïnstalleerd.**
-  **De waarschuwingstickers dienen altijd in goede staat te worden gehouden en vervangen indien versleten, zodat de klant ze goed kan lezen.**
-  **Als zich een fout of probleem voordoet met de machine, dan dient de machine onmiddellijk stopgezet en het probleem verholpen te worden voordat de machine verder gebruikt wordt.**
-  **Installatie, service, aanpassingen of routine-onderhoud dient alleen uitgevoerd te worden door hierin bekwame personen.**
-  **Om blijvende bescherming tegen brandgevaar te garanderen, dient ervoor gezorgd te worden dat de netzekeringen alleen vervangen worden door zekeringen van hetzelfde type en dezelfde sterkte. het gebruik van andere zekeringen of ander materiaal is verboden.**
-  **De voeding in de monitor blijft warm en er kunnen componenten electrisch geladen blijven ondanks dat de machine UITgeschakeld is, waardoor er brandwonden of electrischee schokken kunnen worden opgelopen. Ben voorzichtig en raak deze delen niet aan.**
-  **Om mogelijke electrische schokken a.g.v. storingen te voorkomen, MOET deze machine voorzien zijn van een goed vastzittende aardstekker.**
-  **Mocht het netsnoer op enig moment beschadigd worden, dan moet deze onmiddellijk vervangen worden.**
-  **Zet de machine niet AAN totdat deze correct is geïnstalleerd.**
-  **Voordat de machine op het lichtnet wordt aangesloten, dient gecontroleerd te worden of de machine op het correcte voltage staat afgesteld en of de correcte zekeringen zijn aangebracht.**

## Opmerkingen aangaande Installatie

- ⚠ **Sluit de machine nooit aan op de stroomtoevoer totdat de installatie is voltooid.**
- ⚠ **Om mogelijke elektrische schokken te voorkomen, dient ervoor gezorgd te worden dat de machine middels een goed vastzittende aardstekker op het lichtnet is aangesloten.**
- ⚠ **Om ervoor te zorgen dat klanten niet gewond raken door de beweging van het spel, dient ervoor gezorgd te worden dat er minimaal 500mm ruimte is tussen andere machines of muren.**
- ⚠ **Om schade aan de machine door verkeerd gebruik te voorkomen, dient ervoor gezorgd te worden dat het voltage van het lichtnet 230volts AC bedraagt.**

**OPMERKING:** Als de machine op een gladde ondergrond wordt gebruikt, is het raadzaam rubber matjes onder de stelvoetjes te bevestigen om te voorkomen dat de machine over de vloer gaat glijden.

**OPMERKING:** Om toegang te krijgen tot de voeding- en de CPU-assemblies, dient ervoor gezorgd te worden dat de achterkant van het kabinet minimaal 500mm verwijderd is van de muur of andere machines.

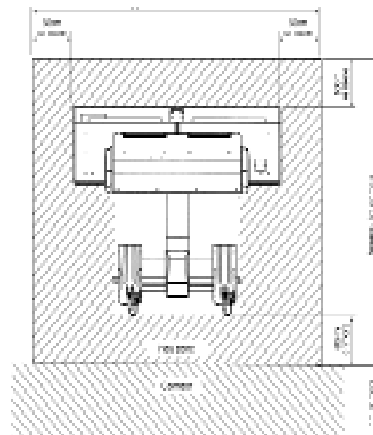

- ⚠ **Het spel is voorzien van wieltjes, waardoor het gemakkelijker is om te verplaatsen. Wees voorzichtig als de machine op een hellend vlak gereden wordt.**
- ⚠ **Het zwaartepunt van de Header Assembly ligt aan diens voorkant, waardoor het belangrijk is dat minimaal 2 personen de Header Assembly aanbrengen of verwijderen.**
- ⚠ **De Header Assembly moet op een hoge positie geplaatst worden en het is dus belangrijk dat deze hoogte veilig kan worden bereikt zonder veel te strekken. (bijv. middels een trap of een kruk)**
- ⚠ **De hoogte van het hoofdgedeelte is 2310mm: kijk dus uit voor obstakels zoals lampen.**
- ⚠ **Als de machine verplaatst of gedragen wordt, dient ervoor gezorgd te worden dat deze in 3 delen wordt afgebroken: Header Assembly, Front Assembly, Ride Assembly**

## Verwijderen en vervangen van Assemblies en onderdelen

- ⚠ **Installatie, service, aanpassingen of routine-onderhoud dient alleen uitgevoerd te worden door hierin bekwaame personen.**
- ⚠ **Maak geen veranderingen aan deze machine zonder goedkeuring vooraf. Dit kan onvoorzien gevaar opleveren.**
- ⚠ **Alleen onderdelen die door Namco Europe Ltd. zijn gespecificeerd dienen gebruikt te worden bij het vervangen of repareren van onderdelen (incl. schroeven).**
- ⚠ **Zorg ervoor dat de machine UITgeschakeld is voordat er enig onderhoudswerk wordt verricht (troubleshooting, reparaties etc.)**
- ⚠ **Bij het verrichten van werkzaamheden die niet in deze handleiding staan beschreven, dient voor instructies altijd contact opgenomen te worden met de verdeler aangezien geen verantwoording wordt genomen voor schade of letsel.**
- ⚠ **Delen van de voeding en de monitor blijven warm of behouden hoogspanning zelfs nadat de machine UITgeschakeld is en zouden verbrandingen of elektrische schokken kunnen veroorzaken. Ben voorzichtig en raak deze delen niet per ongeluk aan.**
- ⚠ **Zorg ervoor dat de machine is UITgeschakeld voordat pluggen of connectors ingestoken of uitgetrokken worden.**
- ⚠ **Als het netsnoer uit de machine of uit het stopcontact verwijderd wordt, dient altijd de stekker vastgepakt te worden en niet het snoer.**



Nenhuma parte desta publicação poderá ser reproduzida por processos mecanográficos, fotográficos, electrónicos ou ainda sob a forma de gravação sonora nem tão pouco poderá ser gravada através de sistemas informáticos transmissíveis ou de outra forma copiados para uso público ou privado sem autorização expressa da NAMCO EUROPA LIMITADA.

A informação contida neste manual foi fornecida de boa fé, sendo rigorosa na altura da sua publicação. A NAMCO EUROPA LIMITADA, reserva-se o direito de proceder a mudanças e alterações sem qualquer aviso prévio.

Esta máquina foi fabricada de acordo com as Directivas Comunitárias Europeias e tem sido testada em conformidade com as seguintes Directivas: 89/336/EEC e 72/23/EEC através dos requerimentos normativos, EN55014, EN55104 e EN60335-1 (ver capa frontal do manual) e como tal sustenta o certificado de marca de CE. Quaisquer alterações ou modificações efectuadas nesta máquina deverão ser em conformidade com as Directivas da Comunidade Europeia. Quaisquer alterações não autorizadas a este equipamento poderão infringir tais Directivas.

O funcionamento normal desta máquina, poderá ser afectado debaixo de algumas condições extremas de interferências externas tais como; transmissões via radio, descargas electrostáticas e passagens de corrente na rede de alimentação. Contudo o seu funcionamento normal será restabelecido logo que a fonte de interferências tenha cessado ou tenha sido neutralizada.

Nota :- Se o processador de jogo for inicializado devido a uma interrupção ou quebra da corrente principal, quaisquer créditos obtidos poderão desaparecer.

Este jogo por si só não constitui uma máquina tal como definido pelas Directivas de Maquinaria de 89/392/EEC8.

## AVISOS DE SEGURANÇA

Afim de usar esta máquina com segurança, certifique-se que lê este manual de operador atentamente antes de proceder à montagem e afinação ou uso da mesma.

Sempre que o proprietário desta máquina confiar a desmontagem, instalação, afinação ou manutenção preventiva da mesma a outra pessoa, deverá este assegurar - se que a pessoa em questão lê as precauções apropriadas e capítulos relevantes deste manual antes de iniciar o trabalho.

Afim de evitar qualquer tipo de acidente quando a máquina estiver em funcionamento, deverá seguir rigorosamente os procedimentos de segurança descritos abaixo.

Este manual juntamente com o manual de instalação (aonde aplicável), constituem parte integrante do equipamento e deverão estar sempre disponíveis ao operador e pessoal técnico de assistência.

Esta máquina destina-se a ser operada em espaços interiores apenas e a sua utilização deve circunscrever-se somente aos fins previstos.

A Namco Ltd. declina qualquer responsabilidade por acidentes, ferimentos ou danos resultantes de modificações não autorizadas ou uso indevido desta máquina.

## AVISOS DE SEGURANÇA

Os seguintes avisos de segurança são usados através de todo o manual. Familiarize-se com cada um destes avisos e respectivos significados antes de instalar, assistir ou efectuar qualquer afinação nesta máquina.

<b>PERIGO</b>		<b>Perigo revela uma situação anormal que poderá resultar em ferimentos ou morte. Não avance para além de um aviso de Perigo sem que todas as condições indicadas estejam completamente esclarecidas e resolvidas.</b>
<b>CAUTELA</b>		<b>Cautela revela uma situação anormal que poderá resultar em danos materiais para a máquina. Não avance para além de um aviso de Cautela sem que todas as condições indicadas estejam completamente esclarecidas e resolvidas.</b>

## AVISOS DE PERIGO

- Esta máquina só deverá ser colocada em funcionamento após ter sido verificado que se encontra instalada correctamente e de acordo com o manual de instruções.**
- Os avisos de perigo devem ser sempre mantidos em boas condições de leitura de forma a permitir uma leitura clara por parte do utilizador, caso se encontrem danificados deverão ser substituídos.**
- Caso esta máquina manifeste algum erro ou problema durante o seu funcionamento, deverá ser imediatamente parada até que o problema em questão seja rectificado.**
- A montagem, assistência e afinações ou manutenção de rotina desta máquina, deverão ser somente executadas por técnicos ou pessoas devidamente qualificadas para o efeito.**
- Afim de garantir uma protecção anti - fogo permanente nesta máquina, certifique-se que os fusíveis de protecção são sempre substituídos por fusíveis de igual valor ou calibre aos de origem. O uso de outro tipo de fusíveis ou material é proibido.**
- A fonte de alimentação do monitor encontrar-se-à quente, tendo zonas de alta voltagem, mesmo após a máquina ter sido desligada. Deste facto poderá resultar a ocorrência de queimaduras ou choques eléctricos. Seja cuidadoso para evitar contacto com estas zonas.**
- Esta máquina deve estar sempre equipada com uma ficha com circuito de protecção à Terra, afim de evitar possíveis choques eléctricos, caso surja uma falha no sistema.**
- Se a qualquer altura o cabo de alimentação principal ficar danificado, deverá ser imediatamente substituído.**
- Não ligar a máquina sem que esta tenha sido correctamente instalada.**
- Antes de ligar a máquina à tomada da rede de alimentação principal, certifique-se de que a máquina está preparada para a voltagem correspondente e de que também se encontra protegida com os fusíveis apropriados.**





Ingen del av denna publikation får reproduceras, varken fotografiskt, elektroniskt eller i någon form av ljudinspelning. Det får inte heller lagras i något återvinningssystem, översändas eller på annat sätt kopieras för offentlig eller privat användning, utan tillstånd från NAMCO EUROPE LIMITED.

Eftersom informationen i denna manual lämnas ut i god tro och var korrekt när den trycktes, reserverar sig NAMCO EUROPE LIMITED för ändringar.

Denna maskin har tillverkats enligt direktiv från europeiska unionen, är testad och uppfyller direktiven enligt 89/336EEC och 72/23/EEC med tillämpning av EN55014, EN55104 och EN60335-1 standard (se manualens framsida) och bär därmed också CE-märket. Varje förändring eller modifiering av denna maskin måste ske i överens-stämmelse med EU-direktiven. En förändring i denna produkt, som inte är auktoriserad, kan strida mot dessa direktiv.

Under vissa omständigheter när det gäller extrema externa störningar, t ex radiosändningar, elektrostatiska urladdningar eller nätburna strömstörningar, kan resultera i en något nedsatt funktion. Maskinen kommer dock att återgå till normal funktion, så snart störningen har upphört eller avlägsnats

OBS! Om spelprocessorn startar om till följd av ett avbrott eller reducering av strömmen kan registrerade krediter gå förlorade.

Detta spel är inte en maskin enligt definitionen i Maskindirektivet 89/392/EEC

## SÄKERHETS VARNING

För att maskinen ska kunna användas på ett säkert sätt, ska manualen läsas noggrant före installation, användning eller justering.

Om ägaren till maskinen anförtror någon annan person att montera isär, installera, justera maskinen eller utföra rutinunderhåll, ska ägaren försäkra sig om att denna person läser om försiktighetsåtgärder och tillämpliga delar av denna manual innan arbetet påbörjas.

För att förhindra att någon olycka händer när maskinen är igång, måste säkerhetspunkterna beskrivna nedan följas strikt.

Denna manual tillsammans med installationsmanualen (när tillämpligt) utgör en integrerad del av utrustningen och måste vara ständigt tillgänglig för operatörer och service personal.

Maskinen är avsedd för inomhusbruk och ska endast användas för detta ändamål.

Namco Ltd. bär inget ansvar för olyckor eller skador som orsakats av icke auktoriserade ändringar i maskinen eller felaktigt användande av densamma.

### SÄKERHETSANVISNINGAR

Säkerhetsanvisningarna nedan används genomgående i manualen. Gör dig förtrogen med varje anvisning och dess innebörd innan installation, service eller justeringar görs på denna maskin.

**WARNING** ⚠ "Varning" anger en fara som skulle kunna skada eller förorsaka dödsfall. Fortsätt inte vid en sådan varningsanvisning innan de påvisade förhållandena är förstådda och åtgärdade i sin helhet.

**OBSERVERA** ⓘ "OBSERVERA" anger en fara som skulle kunna förorsaka skada på maskinen. Fortsätt inte vid en sådan varningsanvisning innan de påvisade förhållandena är förstådda och åtgärdade i sin helhet.

## ALLMÄNNA SÄKERHETSBEAKTANDEN

- ⚠ **Sätt inte igång maskinen utan att ha kontrollerat att den är korrekt installerad och i överensstämmelse med manualen.**
- ⚠ **Varningsanvisningarna måste alltid hållas i gott skick och ersättas när de blir slitna, så att kunderna kan läsa dem tydligt.**
- ⚠ **Om det uppstår fel eller problem med maskinen, måste användningen stoppas omedelbart och problemet rättas till innan den åter används.**
- ⚠ **Installation, service, justeringar eller rutinunderhåll ska endast utföras av en för ändamålet kvalificerad person.**
- ⚠ **För kontinuerligt skydd mot brandfara, ska man försäkra sig om att huvudsäkringarna endast ersätts med samma typ och specifikationer. Användandet av andra säkringar eller material är förbjuden.**
- ⚠ **Strömförsörjningen inne i monitorn håller sig varm och har områden med hög spänning, även när maskinen stängts av och det finns risk för brännskada eller elektriska stötar. Var försiktig och vidrör aldrig sådana områden.**
- ⚠ **För att förhindra en eventuell elektrisk stöt förorsakad av fel, MÅSTE maskinen vara försedd med säkert ansluten JORDAD kontakt.**
- ⚠ **Om strömförsörjningskabeln på något sätt skadas, måste den bytas ut omedelbart.**
- ⚠ **Vrid inte strömbrytaren till ON innan maskinen är korrekt installerad.**
- ⓘ **Innan strömmen sätts på till maskinen, måste man försäkra sig om att den är inställd på rätt spänning och att rätt säkringar är isatta.**



## ATT BEAKTA VID INSTALLATION

- ⚠ Sätt aldrig på strömmen på maskinen innan installationen är klar.
- ⚠ För att förhindra elektriska chocker, försäkra dig om att maskinen kopplas till strömförsörjning med jordad kontakt
- ⚠ För att undvika skador av spelets rörelser, försäkra dig om att det finns ett avstånd på minst 500 mm till annan maskin eller vägg.
- ⓘ För att undvika skador på maskinen p g a felaktigt handhavande, försäkra dig om att strömstyrkan är 230 volt AC.

**OBSERVERA:** Om maskinen är placerad på ett polerat golv, rekommenderas att placera gummibrickor under nivåjusteringen för att förhindra att maskinen glider på golvet.

**OBSERVERA:** För att kunna komma åt strömförsörjningen och CPU, se till att baksidan av huvudkabinettet är placerat minst 500 mm från vägg eller annan maskin.

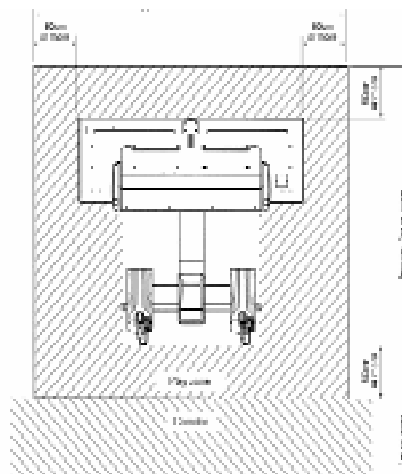

- ⚠ Spelet är försett med hjul för att underlätta förflyttningar. Var försiktig om spelet ska flyttas på en sluttande yta.
- ⚠ Toppskylten har tyngdpunkten framtill, därför är det viktigt att minst 2 personer sätter dit eller tar bort den.
- ⚠ Toppskyltens placering är mycket högt upp och det är viktigt att sådana hjälpmedel används så att man når upp utan att sträcka sig (t ex trappstege, pall osv).
- ⚠ Den totala höjden är 2310 mm, tänk på eventuella högt placerade hinder, t ex lampor.
- ⚠ Om spelet ska flyttas eller bäras, kontrollera att spelet är monterat isär i 3 delar: Toppskylt, Monitorenhet, Spelkontrollenhet

## ATT TA BORT ELLER BYTA UT ENHETER OCH DELAR

- ⚠ Justeringar och underhåll på denna maskin skall endast utföras av kvalificerad personal.
- ⚠ Gör inga ändringar på denna maskin utan ett godkännande i förväg. Detta kan förorsaka oförutsägbar fara.
- ⚠ Endast delar som är specificerade av Namco Europe Ltd. ska användas vid utbyten eller reparation av delar (inklusive skruvar).
- ⚠ Försäkra dig om att strömmen är avstängd innan underhållsarbete påbörjas (felsökning, reparationer etc.)
- ⚠ Om arbete ska utföras som inte är beskrivet i denna manual, är det viktigt att kontakta återförsäljaren för instruktioner eftersom inget ansvar accepteras för åverkan eller personskador.
- ⚠ Delar av strömförsörjningen och monitorn är varma och strömbärande även efter strömmen stängts av och kan orsaka brännskador eller elektriska stötar.
- ⚠ Försäkra dig om att maskinen är avstängd innan kontakter sätts i eller tas ur.
- ⚠ När kontakten tas ur maskinen eller ur väggen, ta alltid tag i kontakten och inte i sladden.



Tästä julkaisusta ei saa ottaa missään muodossa kopioita yksityis- tai julkiseen käyttöön ilman **NAMCO EUROPE LIMITED**:in lupaa.

Tässä ohjekirjassa olevat tiedot pitävät julkaisuhetkellä paikkansa. NAMCO EUROPE LIMITED:illä on kuitenkin oikeus muutoksiin ilman erillistä ilmoitusta.

Tämä laite on valmistettu EC direktiivien mukaisesti. Se on testattu ja todettu noudattavan seuraavia direktiivejä: 89/336/EEC ja 72/23/EEC (EN55014, EN55104 ja EN 60335-1 standardit). Näin ollen tämä laite on varustettu CE-merkinnällä. Kaikki tähän laitteeseen kohdistetut muutokset on tehtävä EC- direktiivien mukaisesti. Mikä tahansa valtuuttamattoman huoltomiehen tekemä muutos voi olla direktiivien vastainen.

Laitteen toiminta voi häiriintyä määrättyissä olosuhteissa, jotka johtuvat äärimmäisistä ulkoisista sähköhäiriöistä, kuten radiolähetyks, elektrostaattinen purkaus tai vahavirrasta syntyneet häiriöt. Toiminta normalisoituu kuitenkin heti, kun ulkoinen sähköhäiriö on poistettu.

Huom.- Jos peliprosessori resetoituu sähkökatkoksen tai vastaavan johdosta, voivat kaikki pelivaraukset hävitä.

Tämä laite ei ole 89/392/EEC direktiivien mukainen kone.

## Turvallisuusvaroitukset

Tämän laitteen turvallinen käyttö edellyttää käyttöohjekirjan huolellista lukemista ennen laitteen asennusta, säätöä tai käyttöä.

Jos tämän laitteen omistaja antaa jollekin toiselle osapuolelle tehtäväksi purkaa, asentaa, säätää tai muuten huoltaa laitetta, on omistajan varmistettava siitä, että toinen osapuoli on lukenut ja ymmärtänyt käyttöohjekirjan oleelliset osat ennen työhön ryhtymistä.

**Turvallisuusohjeita on seurattava tarkoin vahinkojen välttämiseksi laitteen ollessa käytössä .**

Tämä ohje sekä mahdollinen asennusohje muodostavat laitteiston oleellisen osan ja on siksi aina oltava huolto- ja käyttöhenkilökunnan käytettävissä.

Tämä laite on tarkoitettu vain sisätilakäyttöön. Sitä ei saa käyttää muihin tarkoituksiin.

Namco Ltd ei vastaa niistä onnettomuuksista, loukaantumisista tai vahingoista, jotka johtuvat laitteeseen ilman Namco Ltd:n lupaa tehdyistä muutoksista laitteen väärästä käytöstä.











## Turvallisuusohjeet

Tässä käyttöohjekirjassa on käytetty seuraavia turvallisuuteen liittyviä huomautuksia. Tutustu jokaiseen näistä. Älä asenna, huolla tai säädä laitteistoa, ennen kuin olet täysin ymmärtänyt mitä ne tarkoittavat.

**VAARA**  "Vaara" tarkoittaa uhkaa, joka voi johtaa loukkantumiseen tai kuolemaan, **Älä koskaan ohita Vaara-merkintää, ennenkuin ohjeissa esitetyt olosuhteet on ymmärretty täysin.**

**VAROITUS**  "Varoitus" tarkoittaa uhkaa, joka voi johtaa laitteen vioittumiseen. Älä koskaan ohita Vaara-merkintää,

## YLEISET TURVALLISUUSNÄKÖKOHDAT

-  **Varmista, että laite on asennettu oikein ja ohjekirjan mukaisesti ennen käyttöönottoa.**
-  **Varoituslaut on pidettävä hyvässä kunnossa. Jos ne ovat kuluneet, ne on ehdottomasti vaihdettava, jotta asiakkaalla olisi mahdollisuus lukea niitä selvästi.**
-  **Jos laitteeseen tulee vika tai ongelmia, on se pysäytettävä välittömästi ja ongelma selvitettävä ennen uutta käyttöönottoa.**
-  **Vain riittävän ammattipätevyden omaava henkilö saa suorittaa asennus-, huolto-, säätö- tai muita laitteeseen kohdistuvia rutiinitoimenpiteitä.**
-  **Jotta palovaaraa ei syntyisi, saa pääsulakkeita vaihtaa vain samankokoisiin sulakkeisiin. Muiden sulakkeiden tai materiaalin käyttö on ehdottomasti kielletty.**
-  **Monitorin sisällä oleva virtalähde pysyy kuumana ja siinä on alueita, joissa on korkea jännite vaikka laite on kytketty pois päältä. Palovammojen tai sähköiskun saaminen on mahdollista. Älä koske näihin alueisiin.**
-  **Sähköiskujen välttämiseksi vikatapauksissa, laite on ehdottomasti kytkettävä maadoitetulla johdolla maadoitettuun pistorasiaan.**
-  **Vioittunut verkkojohto on välittömästi vaihdettava.**
-  **Älä kytke laitetta päälle, ennen kuin se on oikein asennettu.**
-  **Varmista ennen verkkoon kytkemistä, että virtalähteen jännitteen asetus on asetettu oikealle jännitteelle ja että siinä on oikeat sulakkeet.**

## ASENNUSHUOMIOITA



Älä koskaan kytke laitetta päälle ennen kuin asennus on suoritettu loppuun.



Tämän laitteen virtalähde on kytkettävä maadoitetulla johdolla maadoitettuun pistorasiaan, jotta sähköiskun vaaraa ei olisi.



Varmista, että laitteen ja seinän tai toisen laitteen välissä on vähintään 500 mm, jotta asiakkaat eivät loukkaannu laitteen liikkumisesta johtuen.



Varmista, että virtalähteen jännite on 230 V AC, jotta ei laite vioitu.

Huomio: Jos tämä laite sijoitetaan liukkaalle esim. vahatulle lattialle, suositellaan laitettavaksi kumityyny tai säätöjalkoihin liikkumisen estämiseksi.

Huomio: Varmista, että takaosan taakse jää vähintään 500 mm tilaa, jotta virtalähteeseen ja CPU-korttiin pääsee käsiksi.

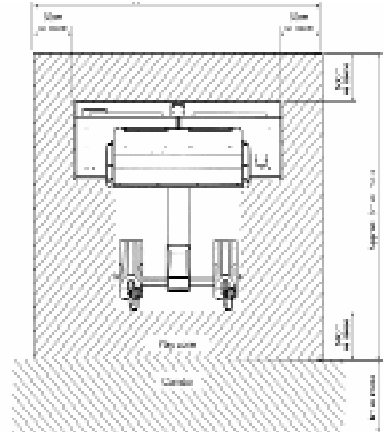

Laite on varustettu kääntyvillä pyörillä. Tämä on pidettävä mielessä, kun laitetta siirretään kaltevalla alustalla.



Yläosan painopiste on yläosan etuosassa. Tästä syystä on yläosaa asennettaessa tai poistettaessa oltava vähintään kaksi henkilöä.



Yläosan asennusasento on erittäin korkealla. On tärkeää, että tarvittavalle korkeudelle päästään vaivattomasti ilman venyttämistä. (esim. käytä tukevia tuoleja tai tikkaita)



Laitteen kokonaiskorkeus on yli 2310 mm. Varmista, ettei katossa ole esteitä. esim. valaisimia.



Kun siirrät tai kannat laitetta varmista, että laite on purettu neljään osaan. Yläosa, koottu, Etuosa, koottu, Liikkuva ajo-osa, koottu



Vain riittävän ammattipätevyden omaava henkilö saa suorittaa asennus-, huolto-, säätö- tai muita laitteeseen kohdistuvia rutiinitoimenpiteitä.



Tälle laitteelle ei saa tehdä mitään hyväksymättömiä muutoksia. Se voi aiheuttaa ennalta-arvaamattomia vaaroja.



Vain Namco Europe Ltd:n määrittelemiä varaosia saa käyttää vaihtaessasi tai korjatessasi osia. (sisältäen ruuvit).



Varmista, että laite on kytketty POIS PÄÄLTÄ ennen työn aloittamista.



Ota yhteyttä maahantuojaan ohjeita varten, jos joudut tekemään työtehtäviä, joita ei ole esitelty huoltokirjassa, muuten vastuuta vioista tai loukkaantumisista ei ole.



Virtalähde ja monitori pysyvät kuumina ja niissä on alueita, joissa on korkeajännite vaikka laite on kytketty pois päältä. Palovammojen tai sähköiskun saaminen on mahdollista. Älä koske näihin laitteisiin.



Varmista, että laite on kytketty POIS PÄÄLTÄ ennen johtojen kytkemistä tai irrottamista.



Irrottaessasi verkkojohdon seinästä tai laitteesta, ota kiinni itse pistokkeesta, ei johdosta.

# Contents

Operators Manual .....	1
PORTABLE APPLIANCE TESTING .....	3
GENERAL SAFETY CONSIDERATIONS .....	4
ALLGEMEINE SICHERHEITSHINWEISE .....	6
GENERELLE SIKKERHEDSOVERVEJELSER .....	8
CONSIDERACIONES GENERALES DE SEGURIDAD .....	10
CONSIGNES GENERALES DE SECURITE .....	12
ΕΞΕΤΑΣΗ ΓΕΝΙΚΗΣ ΑΣΦΑΛΕΙΑΣ .....	14
CONSIDERAZIONI GENERALI SULLA SICUREZZA .....	16
VANLIGE SIKKERHETSTILTAK .....	18
ALGEMENE VEILIGHEIDSOVERWEGINGEN .....	20
AVISOS DE PERIGO .....	22
ALLMÄNNA SÄKERHETSBEAKTANDEN .....	24
YLEISET TURVALLISUUSNÄKÖKOHDAT .....	26
1. SPECIFICATIONS .....	29
2. HOW TO PLAY .....	30
3. MAJOR COMPONENTS .....	31
4. MOVING THE MACHINE .....	32
5. INSTALLATION .....	32
5-1 Joining the Monitor (L) and (R) Assemblies .....	36
5-2 Fitting the Header Assembly .....	39
5-3 Fitting the Coin Tower .....	40
5-4 Fitting the Pedal Assembly .....	41
6. ADJUSTMENTS .....	42
6-1 Turning on the Power .....	42
6-2 Adjustment Switches .....	43
6-3 Test Mode .....	44
6-3-1 Coin Options .....	45
6-3-2 Game Options .....	46
6-3-3 I/O Test .....	47
6-3-3-1 I/O PCB Check .....	48
6-3-3-2 Gun Initialize .....	49
6-3-3-3 Switch Test .....	52
6-3-3-4 Solenoid Test .....	53
6-3-4 Monitor Test .....	54
6-3-5 Sound Test .....	55
6-3-6 ADS Data .....	56
6-3-7 Others .....	56
7. REMOVING AND REPLACING ASSEMBLIES AND PARTS .....	57
7-1 Removing the Monitor from the Monitor Base .....	57
7-2 Replacing the Fluorescent Tube or Starter .....	59
7-3 Replacing the Pedal Switch .....	60
7-4 Greasing the Pedal Assy Plunger .....	61
7-5 Replacing the Pedal Plunger .....	62
7-6 Gun Assembly .....	63
7-6-1 Replacing the Gun Assembly .....	63
7-6-2 Removing the Gun Slide .....	64
7-6-3 Removing the Gun Cover .....	65
7-6-4 Replacing the Solenoid .....	66
7-6-5 Replacing the Trigger Switch .....	67
7-6-6 Replacing the Flexible Gun Conduit .....	67
8. PARTS .....	68
9. SCHEMATICS .....	78

# 1. SPECIFICATIONS

**POWER SUPPLY:-** 230volts / 450watts AC

**AMBIENT OPERATING TEMPERATURE:** +5°C to +25°C

**MONITOR:-** Pioneer 50" Projector Monitor

**COIN ACCEPTOR:-** Mars CashFlow 4 Channel - Dispense

**DIMENSIONS:-**

Assembled	1500(w) x 1510(d) x 2090(h)
Monitor Cabinet	1500(w) x 790(d) x 1730(h)
Coin Tower	1100(w) x 720(d) x 1110(h)
Header Assembly	1460(w) x 380(d) z 480(h)
Pedal Assembly	250(w) x 250(d) x 160(h)

**WEIGHT:-**

Assembled	279kg
Monitor Cabinet	205kg
Coin Tower	42kg
Header Assembly	24kg
Pedal Assembly	4kg

**ACCESSORIES:-**

Keys:	(Cash Door) .....	2
	(Coin Door) .....	2
	(Back Door) .....	2ea
	IEC Mains Lead .....	1
	Operators Manual .....	1
	Monitor Manual .....	1
	CashFlow Documents .....	1
	M5 Security Wrench .....	1
	M6 Security Wrench .....	1
	Hex Head Set Screw (M8x40) .....	4
	Hex Head Set Screw (M8x20) .....	4
	Socket Head Machine Screw (M8X25) .....	4
	Button Head Machine Screw (M6x30) .....	4
	Flat Washer - Black (M6) .....	4
	Spring Washer - Black (M6) .....	4
	Socket Cap Machine Screw (M5x12) .....	8
	Flat Washer - Black (M5) .....	8
	Spring Washer - Black (M5) .....	8

## 2. HOW TO PLAY

This is a gun shooting game where players press on a foot pedal to hide behind an object to avoid an enemy attack, then release the pedal to get out from behind the object and attack the enemy.

### HOW TO CONTROL

1. Step on the pedal = attack position. In this position you can shoot the enemy. You are also subject to an attack.
2. Release the pedal = defence position. In this position you are hidden behind an object and cannot be hit by the enemy. Releasing the pedal also reloads the gun.

### MODES

1. Linked play mode: This mode is for two player co-operative play. If selected by a single player an additional player can join the game after it has started.
2. Solo play mode: This mode is for a single player only. No one can join the game once it has started.

\* Modes are selected on the Mode Selection Screen at the start of the game.

### RULES



1. Every time you are hit by the enemy you lose a life. You also lose a life if the time period for that scene reaches zero. the time period is restored at the start of a new life or when the scene has been completed. The game is over when all lives are lost.
2. A player's achievement is assessed by score at the end of the game. The higher the score, the higher the achievement.

Demonstration video clips between games can be skipped by aiming and shooting the gun at the screen.

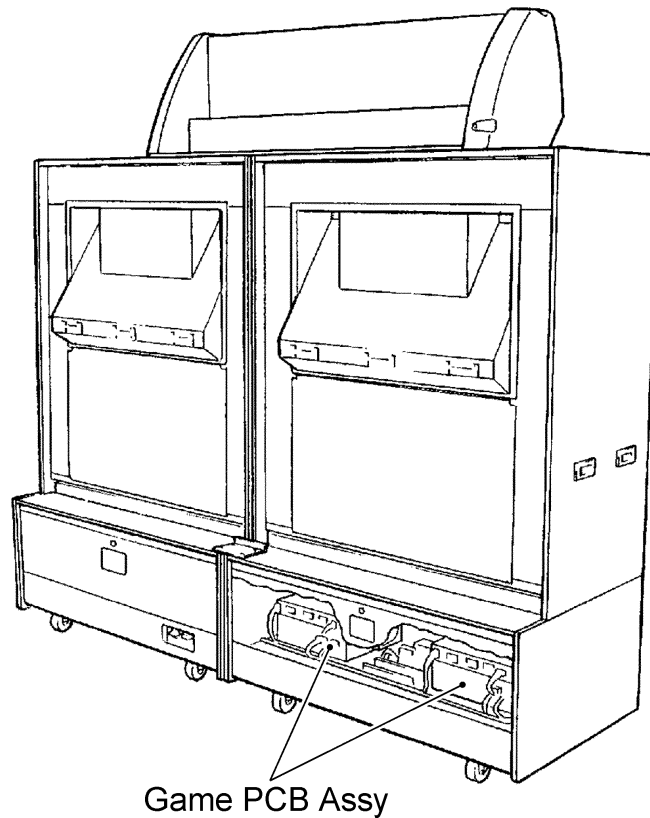
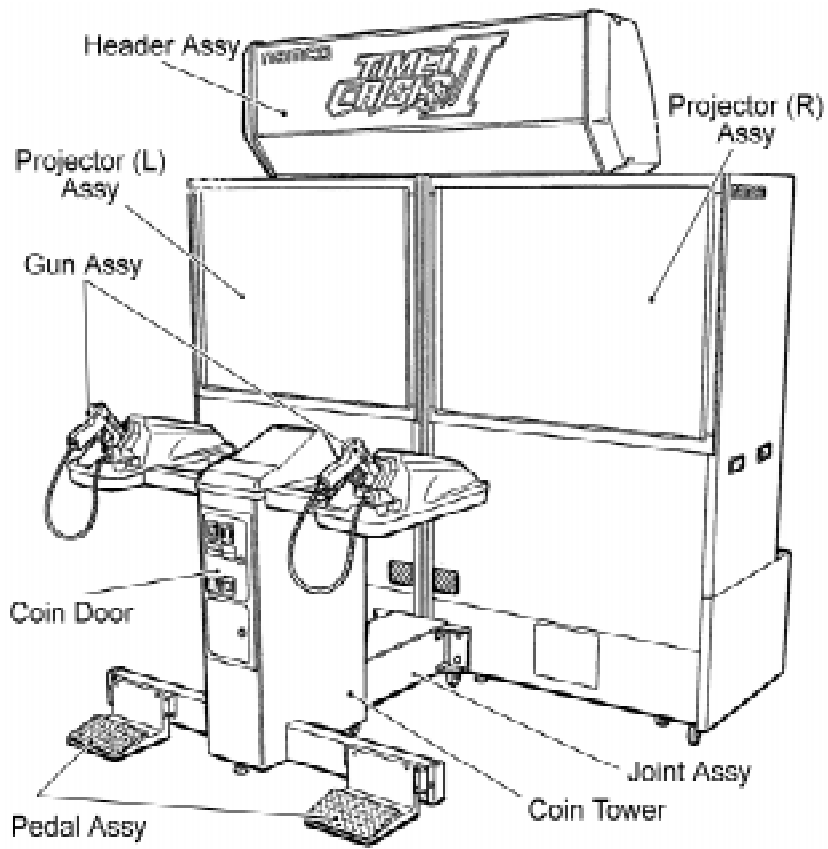
### 3. MAJOR COMPONENTS



## 4. MOVING THE MACHINE

-  **This machine is fitted with castors to make it easier to move. Take care when moving the machine on an inclined surface.**
-  **The overall height of the machine is 2310mm. Take care of any overhead obstructions. (e.g. Light Fittings, Electric Cables etc.)**
-  **When moving the game, ensure that the game is dis-assembled into 4 parts: Monitor Assemblies, Coin Tower, and Header Assembly.**

## 5. INSTALLATION

### Notes on Installation

- WARNING** • **NEVER turn the power to the machine ON until installation has been completed.**
- WARNING** • **In order to prevent possible electric shocks, be sure that the machine is connected to the mains with a securely connected earthed plug.**
- WARNING** • **So that customers are not injured , ensure that there is at least 500mm separation between other machines or walls.**
- CAUTION** • In order to avoid damage to the machine due to mis-operation, ensure that the voltage of the mains supply is 230volts AC.

- NOTE** • If the location site of this machine has a polished floor it is recommended that rubber pads are fitted under the level adjusters to prevent the machine sliding on the floor.
- In order to gain access to the Power Supply and CPU assemblies, make sure that the rear of the machine is separated from a wall or other machine by at least 500mm.
- When installation is complete, it is imperative that the game is initialized. ([See section 6-3-3-2 page 49](#))





**This machine is designed for INDOOR USE ONLY.  
Do not install in the following places.**

1. **Outdoors**
2. **Direct Sunlight, places with excessive humidity or dust, places where there is water leakage, near air-conditioning or heating equipment, places with excessive heat or cold temperature.**
3. **Places where it would be in the way of emergency exits or fire extinguishing equipment.**
4. **Unstable places or places with excessive vibration.**
5. **Places that are not level.**
6. **This machine must not be cleaned with a water jet, or installed in an area where a water jet could be used.**



**DIESES GERÄT IST NUR FÜR DIE GEWERBLICHE AUFSTELLUNG IN  
GESCHLOSSENEN RÄUMEN BESTIMMT.  
DAS GERÄT DARF AN FOLGENDEN PLÄTZEN NICHT AUFGESTELLT WERDEN**

1. **Im Freien.**
2. **In direktem Sonnenschein, an extrem feuchten und staubigen Plätzen, an Plätzen mit Wasseranschlüssen und möglichen Leckagen, nahe Klima- und Heizungsanlagen, an Plätzen mit extrem hohen oder niedrigen Temperaturen.**
3. **In der Nähe von Notausgängen oder Feuerlöschgeräten.**
4. **An unstablen Plätzen oder Plätzen mit übermäßiger Vibration.**
5. **An Plätzen, die nicht eben sind.**



**DENNE MASKINE ER KUN DESIGNET TIL INDENDØRSBRUG  
INSTALLER IKKE MASKINEN PÅ FØLGENDE STEDER**

1. **Udendørs**
2. **Direkte sollys, steder med høj fugtighed el. støv, steder med vand udslip, i nærheden af air-condition eller varme udstyr, steder med usædvanlig høj el. kold temperatur.**
3. **Steder hvor den vil stå i vejen for nødudgange eller brandslukningsudstyr.**
4. **Ustabile steder eller steder med for store vibrationer.**
5. **Steder der ikke er plane.**



**ESTA MÁQUINA ESTA DISEÑADA ÚNICAMENTE PARA USO EN  
INTERIORES. NO INSTALE LA MÁQUINA EN LOS SIGUIENTES LUGARES.**

1. **Exteriores.**
2. **Bajo luz solar directa, en lugares con polvo o humedad excesiva, lugares donde hay filtraciones de agua, cerca de aparatos de calefacción o de aire acondicionado, lugares con temperatura ambiente muy alta o muy baja.**
3. **Lugares donde la máquina obstruya salidas de emergencia o equipos de extinción de incendios.**
4. **Suelos inestables o lugares con vibraciones excesivas.**
5. **Lugares con suelos no nivelados.**



**F**

**CETTE MACHINE EST DESTINEE UNIQUEMENT A UN USAGE INTERIEUR  
NE PAS INSTALLER LA MACHINE DANS LES ENDROITS SUIVANTS**

1. A l'extérieur.
2. Directement exposée au soleil, aux endroits excessivement humides ou poussiéreux, aux endroits où il y a des risques de fuite d'eau, près de ventilateurs ou source de chaleur, aux endroits très chauds ou froids.
3. Dans des zones de proximité des sorties de secours ou d'accès aux équipements d'extinction du feu.
4. Dans des emplacements instables ou soumis à de fortes vibrations.
5. Dans des endroits dénivelés.

**GR**

**ΤΟ ΜΗΧΑΝΗΜΑ ΕΙΝΑΙ ΣΧΕΔΙΑΣΜΕΝΟ ΓΙΑ ΧΡΗΣΗ ΣΕ ΕΣΩΤΕΡΙΚΟ ΧΩΡΟ  
ΜΟΝΟ  
ΜΗΝ ΤΟΠΟΘΕΤΗΣΕΤΕ ΤΟ ΜΗΧΑΝΗΜΑ ΣΤΟΥΣ ΑΚΟΛΟΥΘΟΥΣ ΧΩΡΟΥΣ**

1. Εξωτερικά
2. Απευθείας στον ήλιο, σε μέρη όπου υπάρχει υγρασία ή σκόνη, μέρη όπου υπάρχει άφθονο νερό, κοντά σε air-condition ή άλλου είδους θέρμανση, μέρη με υπερβολική υψηλή ή χαμηλή θερμοκρασία.
3. Σε μέρη όπου εμποδίζουν μέσα ανάγκης π.χ. πυροσβεστήρες ή άλλα.
4. Μη σταθερά μέρη ή μέρη με πολλούς κραδασμούς.
5. Μέρη που δεν είναι επίπεδα.

**I**

**QUESTA MACCHINA E' PROGETTATA PER ESSERE USATA  
ESCLUSIVAMENTE IN AMBIENTI INTERNI.  
NON INSTALLARE LA MACCHINA NEI SEGUENTI LUOGHI.**

1. In ambienti esterni.
2. Alla luce diretta del sole, in posti con eccessiva umidità o polvere, in luoghi dove ci siano infiltrazioni d'acqua, vicino ad apparecchi di condizionamento d'aria oppure riscaldamento, in posti eccessivamente caldi o freddi.
3. In luoghi dove potrebbe esserci un uscita di emergenza o un'attrezzatura per lo spegnimento del fuoco.
4. In posti non stabili o con eccessive vibrazioni.
5. In luoghi non piani.

**N**

**DENNE MASKINEN ER BARE KONSTRUERT FOR INNENDØRS BRUK  
IKKE INSTALLER MASKINEN PÅ FØLGENDE Plasser.**

1. Utendørs
2. Konstant sollys, plasser med mye fuktighet og støv, plasser hvor det er vannlekasje, nære luft kjølere eller varme elementer, plasser med overdreven høy eller lav temperatur.
3. Plasser hvor det vill stå i veien for nødutganger eller brannslukking utstyr.
4. Ustabile plasser eller plasser med overdreven vibrasjon.
5. Plasser som ikke er i vater.



**(NL)** **DEZE MACHINE IS ALLEEN VOOR GEBRUIK BINNENSHUIS ONTWORPEN  
INSTALLEER DE MACHINE NIET OP DE VOLGENDE PLAATSEN**

1. Buiten
2. In direct zonlicht, op plaatsen met een zeer hoge vochtigheidsgraad of met veel stof, op plaatsen waar een waterlek is, dichtbij airco's of verwarmingsapparatuur, op plaatsen met een zeer hoge of koude temperatuur.
3. Op plaatsen waar nooduitgangen of blusapparatuur worden geblokkeerd.
4. Op onstabiele plaatsen of plaatsen waar grote trillingen voorkomen.
5. Op plaatsen die niet vlak zijn.

**(P)** **ESTA MAQUINA FOI CONCEBIDA PARA UTILIZAÇÃO EM ESPACOS  
INTERIORES APENAS  
NÃO INSTALAR A MAQUINAS NOS SEGUINTES LOCAIS:-**

1. Exteriores.
2. Luz solar directa, locais com humidade excessiva ou pó, locais aonde existam fugas de água perto de ar condicionados ou equipamentos caloríficos e locais com temperaturas excessivamente quentes ou frias.
3. Locais aonde ficaria colocada no caminho de saidas de emergência ou equipamentos extintores de fogo.
4. Locais estruturalmente instáveis ou locais com vibrações excessivas.
5. Locais não nivelados.

**(S)** **DENNA MASKIN ÄR AVSEDD ENBART FÖR INOMHUSBRUK  
INSTALLERA EJ MASKINEN PÅ FÖLJANDE STÄLLEN**

1. Utomhus
2. I direkt solsken, platser med extremt hög luftfuktighet eller damm, platser där det förekommer vattenläckage, nära luftkonditionering eller värmeelement, i extremt hög eller låg temperatur.
3. Platser där den skulle kunna vara i vägen för nödutgångar och brandsläckningsutrustning.
4. Instabila ställen eller där stark vibration förekommer.
5. Platser med nivåskillnad.

**(SF)** **TÄMÄ LAITE ON SUUNNITELTU VAIN SISÄKÄYTTÖÖN  
ÄLÄ ASENNÄ LAITETTA SEURAAVIIN PAIKKOIHIN:**

1. Ulkotilaan
2. Suoraan aurinkovaloon, kosteisiin tai pölyisiin paikkoihin, vesivuotopaikkojen läheisyyteen, ilmanvaihto- tai lämmityslaitteen lähistölle tai paikkoihin, jossa on erittäin kuumaa tai kylmää.
3. Varaueloskäytävien, muiden pakoteiden tai tulensammutusvälineiden eteen.
4. Epävakaasiin tai täriseviin paikkoihin.
5. Kaltevalle alustalle.

## 5-1 Joining the Monitor (L) and (R) Assemblies

1. Place the monitor (L) and (R) assemblies together in their final location and lower the eight, (4 on each monitor), level adjusters until the castors are raised approx 5mm from the ground.

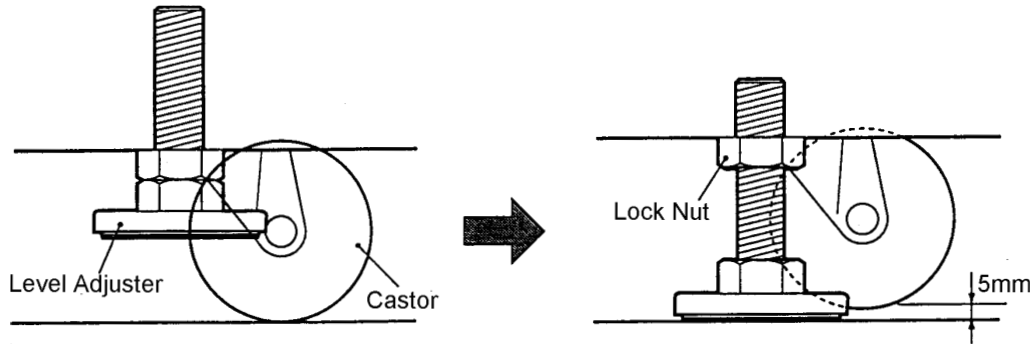

**NOTE:-** When adjusting the level adjusters, ensure that the top and front faces of the monitor assemblies are level with each other. Poor adjustment will prevent the fitting of the Joint Assy and Header Assy.

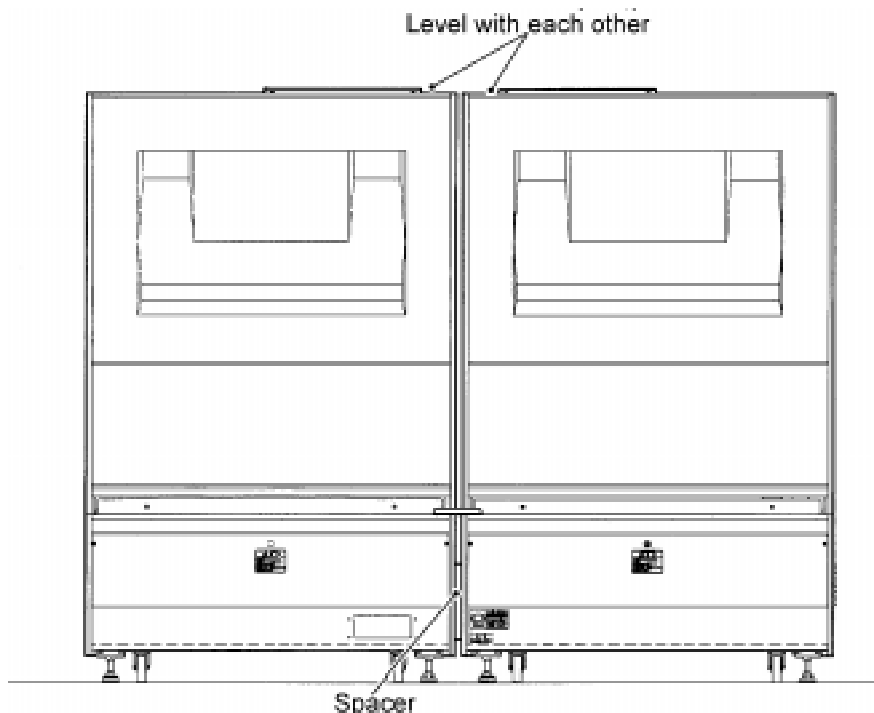

**Note:** If the location site of this machine has a polished floor it is recommended that rubber pads are fitted under the level adjusters to prevent the machine sliding on the floor when in use.

2. Fit the joint bracket with the supplied 4 off flange socket head screws (M8x20)

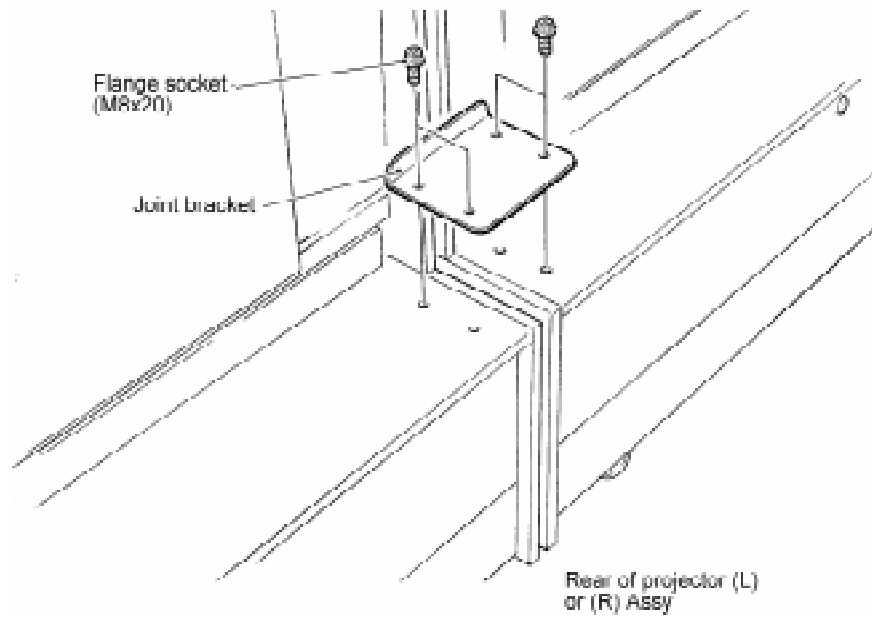

3. Fit the supplied 4 off flange socket head screws (M8x40) to the front of both monitor (L) and (R) assemblies finger tight, leaving a clearance of approx. 5mm.

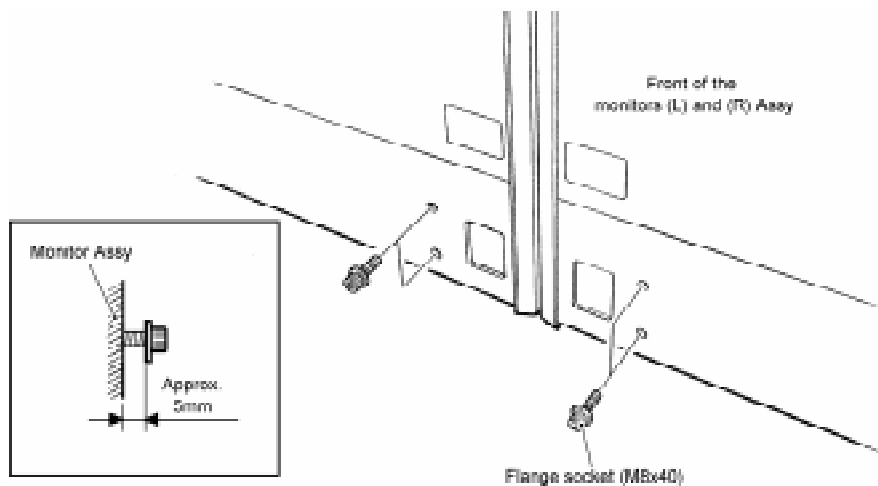

4. Fit the joint assy, (shipped with Header Assy), to the monitors and tighten the 4 off flange socket head screws (M8x40).
5. Pull the loom connectors from the monitor assemblies.

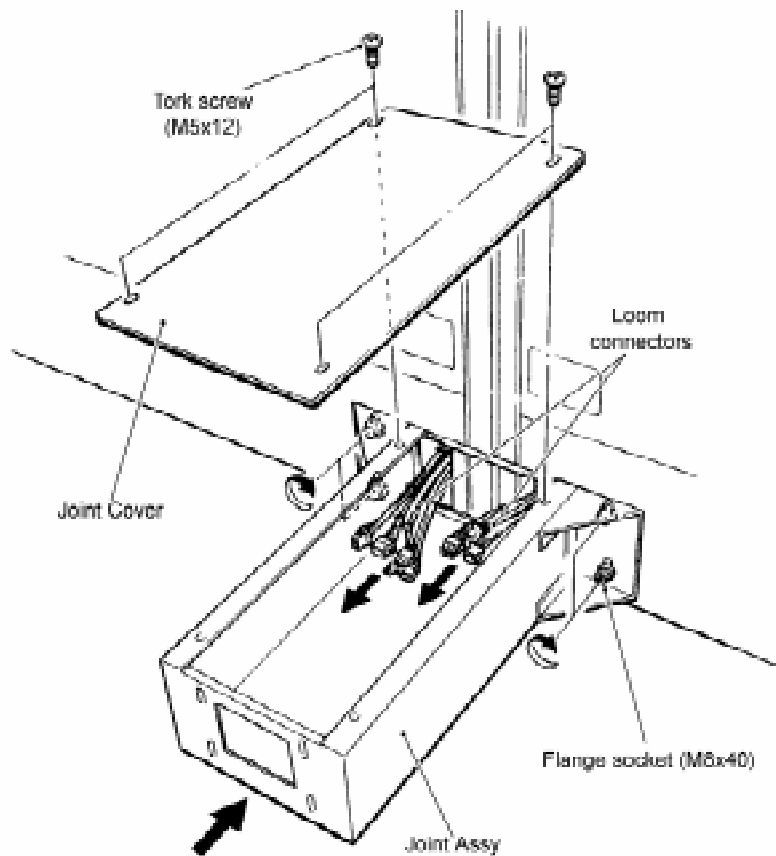

## 5-2 Fitting the Header Assembly

The Header Assembly has a forward centre of gravity, so it is important that at least two people are used to fit or remove the Header Assembly.

The fitting position of the Header Assembly is very high, and it is important that a means of reaching the height safely, without stretching, is available. (e.g. steps, step stool etc.)

1. Remove 2 off tork screws (M5x15) and remove the connector cover.
2. Place the header on to the monitor cabinets and slide it backwards so that it engages under the fixing brackets at the back.
3. Connect the connector, and refit the connector cover using the 2 off tork screws (M5x15).
4. Retain the header in position with supplied 4 off hex head screws (M6x30), flat and spring washers, and supplied washers C.

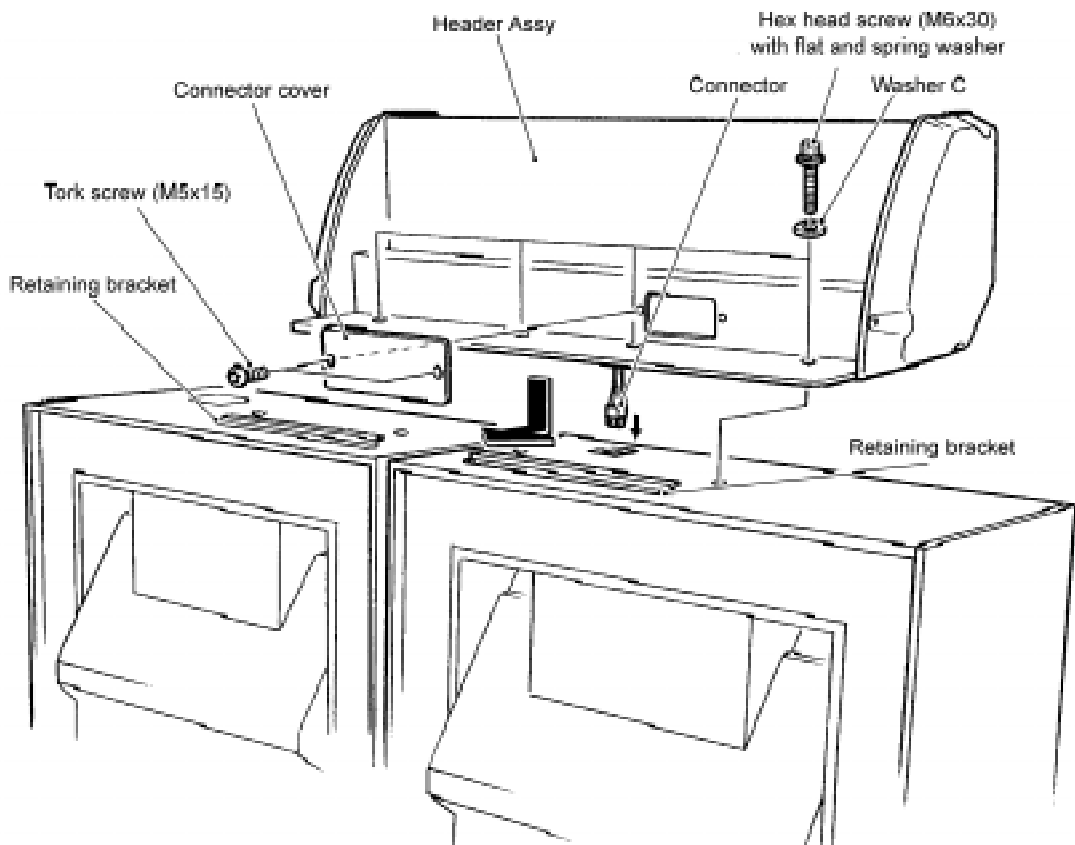

### 5-3 Fitting the Coin Tower

1. Place the coin tower up to the Joint Assy.
2. Fit the supplied 4 off flange socket head screws (M8x20) to fix the Coin tower to the Joint Assy.
3. Pull the harness out from the coin tower.

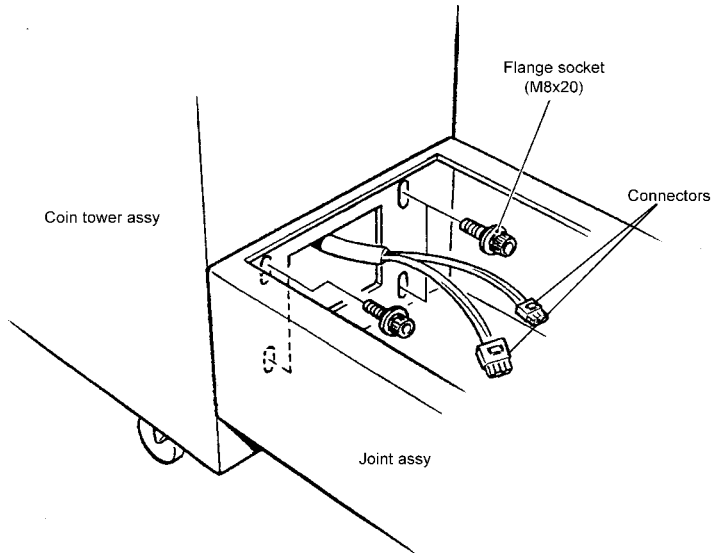

4. Connect the six connectors.
5. Fit the joint cover using 4 off tork screws (M5x12).

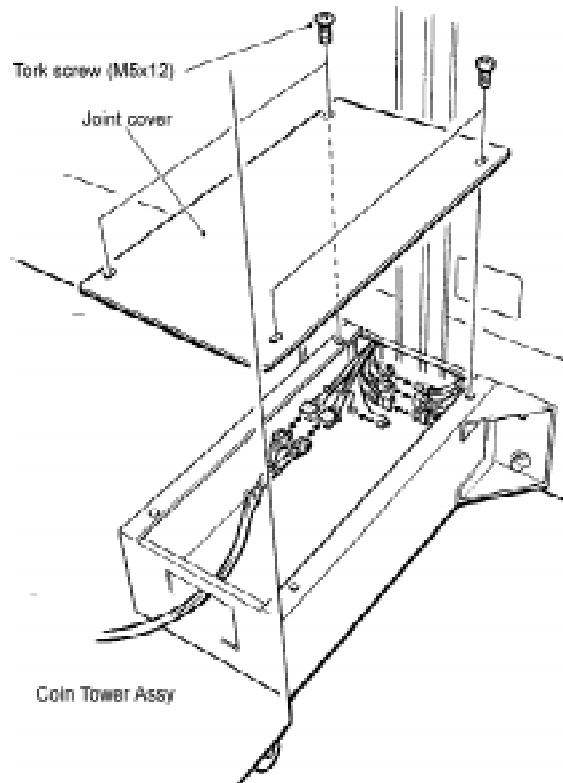



## 5-4 Fitting the Pedal Assembly

1. Connect the connector between the pedal assy and coin tower assy.
2. Slacken the Flange socket head screws (M6x20) retaining the pedal brackets.

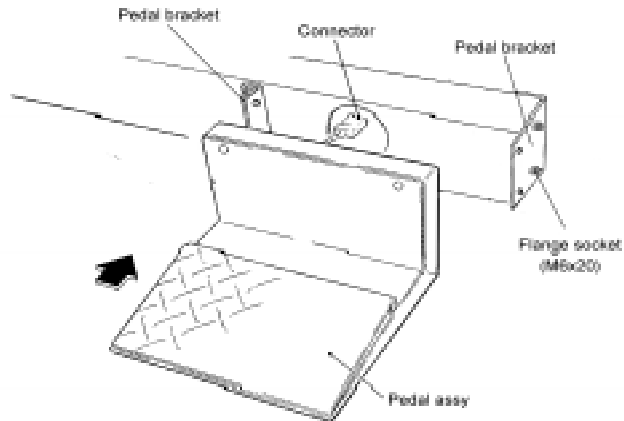

3. Place the pedal assy between the pedal brackets and fit, finger tight, the supplied 4off flange socket head screws (M5x12) taking care not to trap any wires.

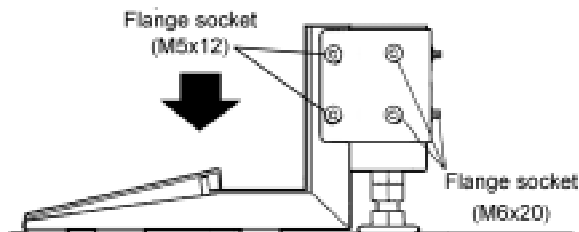

4. Ensure that the pedal assy is against the floor and tighten the 4off flange socket head screws (M5x12)  
*Note: Make sure that the pedal assy does not lift from the floor.*
5. Re-tighten the flange socket head screws (M6x20).

## 6. ADJUSTMENTS



- Ⓒ **Adjustment or maintenance on this machine should be carried out by qualified personnel only.**
- Ⓓ **Aufstellung, Service, Einstellung und Wartung dürfen nur von dafür qualifiziertem Fachpersonal durchgeführt werden.**
- Ⓓ **Justeringer eller vedligehold af denne maskine bør kun udføres af kvalificeret personale.**
- Ⓔ **Los ajustes y el mantenimiento de esta máquina deben ser realizados sólo por personal cualificado.**
- Ⓕ **L'installation, le service, le réglage, ou la maintenance doivent être effectués uniquement par les personnes qualifiées.**
- Ⓖ **Μετατροπές ή επιδιορθώσεις στα μηχανήματα πρέπει να γίνονται μόνο από εξουσιοδοτημένα άτομα.**
- Ⓘ **Regolazioni e manutenzione su questa macchina devono essere fatti solo da personale specializzato.**
- Ⓝ **Justering eller vedlikehold på denne maskinen skall bare utføres av kvalifiserte personell.**
- Ⓝ **Aanpassingen of onderhoud aan deze machine dient alleen uitgevoerd te worden door bekwaam personeel.**
- Ⓟ **Afinações ou manutenção nesta máquina, deverão ser efectuadas sómente por pessoal qualificado.**
- Ⓢ **Justeringar och underhåll på denna maskin skall endast utföras av kvalificerad personal.**
- Ⓢ **Tätä laitetta saa säätää tai huoltaa vain siihen ammattipätevyyden omaava henkilökunta.**

### 6-1 Turning on the Power

After the machine has been installed, turn ON the power. The power switch is located on the rear of the monitor cabinet.

## 6-2 Adjustment Switches

The Adjustment switches are located inside the coin door.

1. Service Switch.  
Press this switch to obtain game credits without incrementing the play meter.
2. Test Switch  
Slide the test switch ON to enter test mode.  
Test mode allows testing and the changing of game settings. ([Refer to section 6-3 "Test Mode" page 44](#))
3. Select Up/Down Switch  
This switch is used to select the test required when in the Test Mode.
4. Enter Switch  
This switch is used to enter a selected test and to change settings within a test.

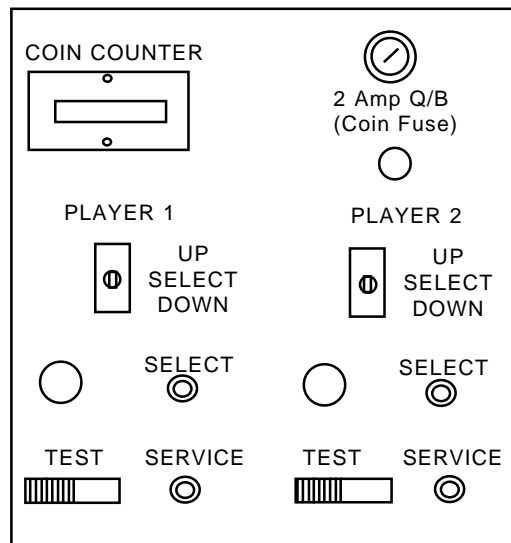

### 6-3 Test Mode

1. Open the coin door and slide the test switch "ON". The "Menu Screen" will be displayed on the monitor.
2. Select the test required by using the select up/down switch. The colour of the selected test will change.
3. Activate the test by pressing the Enter switch. Select "EXIT" in each test to return to the "Menu Screen".
4. After testing is completed, slide the test switch to the "OFF" position to return to normal game mode.

*The Test Switch must always be in the "OFF" position for normal game mode.*

MENU	
COIN OPTIONS .....	Used to set the price of play
GAME OPTIONS .....	Used to set the game options
I/O TEST .....	Used for testing switches & Gun
MONITOR TEST .....	Used for setting the monitor
SOUND TEST .....	Used for setting the volume
ADS DATA .....	Used to view bookkeeping
OTHERS .....	Used for testing the PCB
LINK MALFUNCTION 1 2 3 .....	(a) } Do not appear when OK
GAME DIFFICULTY L/R:NOT THE SAME .....	(b) }
The internal battery's dead .....	(c) }
SELECT SW : CHOOSE    ENTER SW : ENTER	

- (a) Error message related to link play
  - A message appears if the link play is defective. The number displayed represents the type of error
  - when 1 or 2 is displayed either the main PCB or memory PCB may be defective. Contact your distributor.
  - If 3 is displayed, the software version on the left game PCB is different from that on the right game PCB. Contact your distributor.
- (b) Error message related to difficulty settings
  - A message appears if the difficulty settings of the left and right game PCBs are different. Enter GAME OPTIONS in the test mode and set both PCBs the same.
- (c) Low battery display
  - A message appears if the Main PCB battery is faulty. Contact your distributor.

### 6-3-1 Coin Options

1. Select "COIN OPTIONS" on the menu screen to set the game cost and related settings. The following screen is displayed.
2. Use the Select Up/Down switch to choose the required item then press the Enter button.
3. Use the Up/Down switch to change the setting.
4. Press the Enter button after the changes have been made to return to the options.
5. Select "EXIT" and press the Enter button to return to the menu screen.

*Note:- The price of play on this machine is set within the Cashflow Coin Mech. Ensure that the Game Cost is set to 1 Coin 1 Credit.*

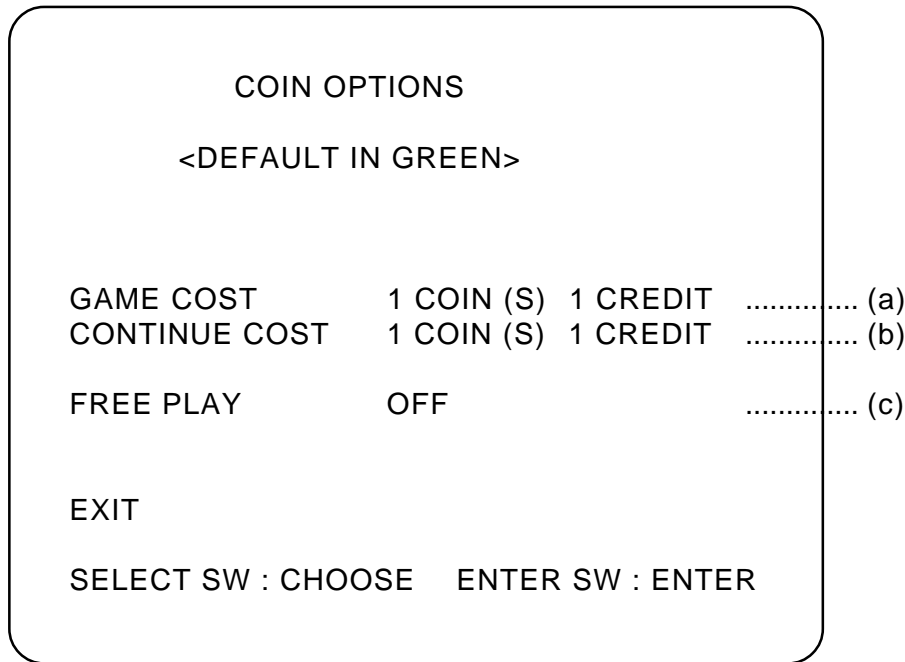

ITEM	DESCRIPTION	FACTORY SET
(a) Game Cost	Coins required for number of Credits -----settable 1 - 9	1 Coin 1 Credit
(b) Continue	Coins required to continue ----- settable 1 - 9	1 Coin 1 Credit
(c) Free Play	No coins required for credit ----- On (Yes) / Off (No)	OFF

### 6-3-2 Game Options

1. Select "GAME OPTIONS" on the menu screen to set the game variables. The following screen is displayed.
2. Use the Select Up/Down switch to choose the required item then press the Enter button.
3. Use the Up/Down switch to change the setting.
4. Press the Enter button after the changes have been made to return to the options.
5. Select "EXIT" and press the Enter button to return to the menu screen.

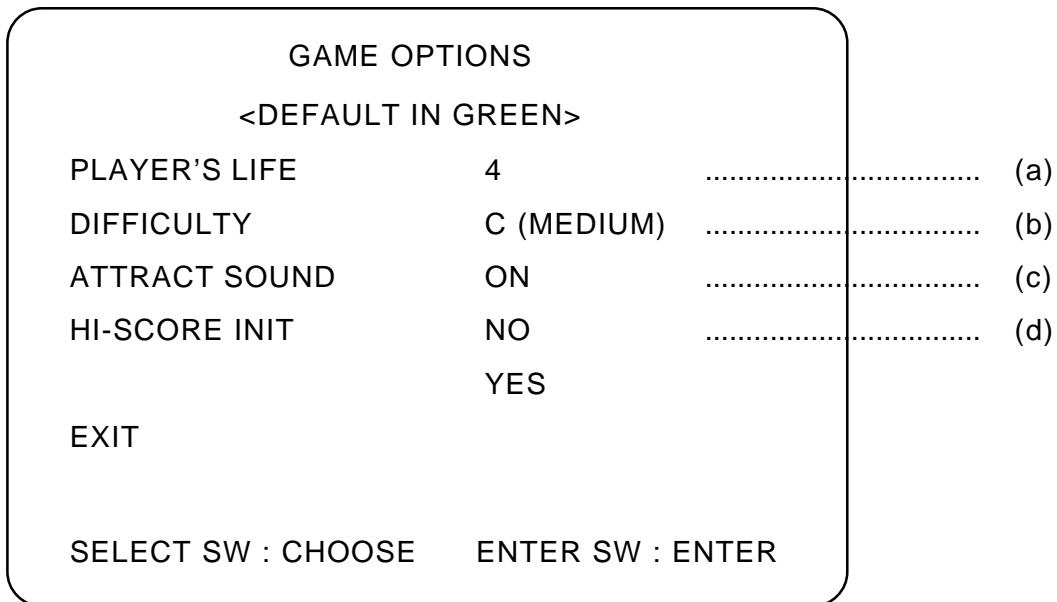

ITEM	DESCRIPTION	FACTORY SET
(a) Player's Life	Number of lives at game start ---- settable 1 - 9	4
(b) Difficulty	A (Very Easy) B (Easy) C (Medium) D (Hard) E (Very Hard)	C (Medium)
(c) Attract Sound	Sound in attract mode ON /OFF	ON
(d) Hi-Score Init?	Hi-Score initialized at power up YES/NO	NO

**NOTE:** *The game will not function correctly unless the difficulty setting is the same for both players.*

### 6-3-3 I/O Test

1. Select "I/O TEST" on the menu screen to switches and lamps. The following screen is displayed.
2. Use the Select Up/Down switch to choose the required item then press the Enter button to enter the test.
3. Select "EXIT" and press the Enter button to return to the menu screen.

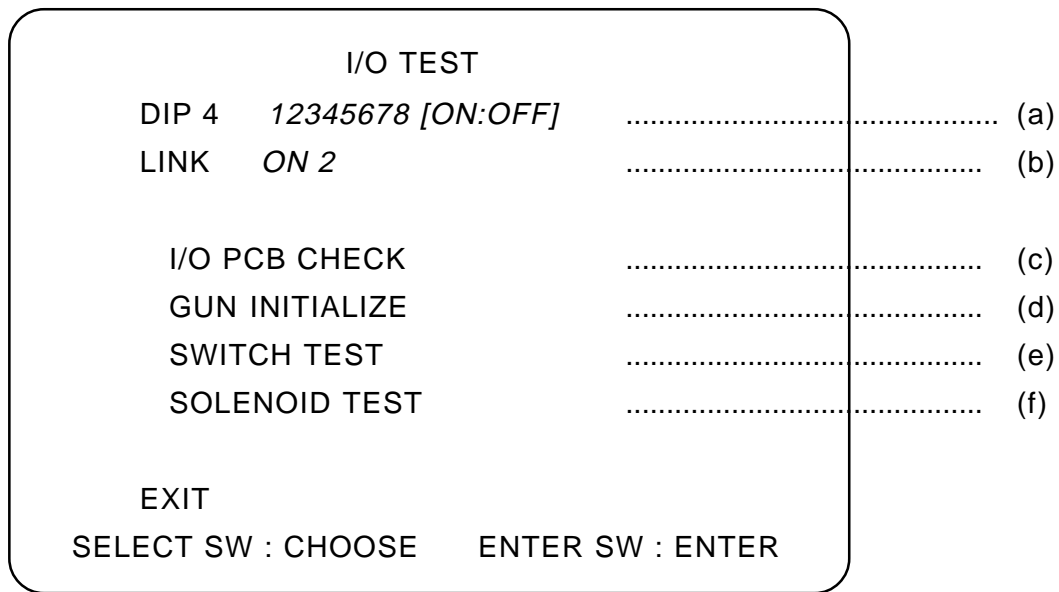

- (a) Shows the condition of the DIP Switches on the PCB. In normal operation all switches are OFF. (If a switch is ON, it will be displayed in red.)
- (b) Checks that both game PCBs are communicating.  
If the communication is good LINK ON 2 will be displayed  
If link data is wrong LINK OFF will be displayed.  
If unrecognisable data is being received LINK NG will be displayed.
- (c) Checks function of I/O PCB.
- (d) Used to test and initialize the gun operation ([see Section 6-3-3-2 page 49](#))
- (e) Selecting this item allows all switches and pedal sensor to be checked.  
([See 6-3-3-3 page 52](#))
- (f) Selecting this item allows the testing of the gun recoil solenoid.  
([See 6-3-3-4 page 53](#))

### 6-3-3-1 I/O PCB Check

1. Select 'I/O PCB CHECK' from the I/O Test Screen. The following screen is displayed:-

```

                                I/O TEST
DIP 4   12345678 [ON:RED]
LINK   ON 2

      I/O PCB CHECK
Master TX 3536 NAMCO LTD.
Time Crisis 2 ; Ver1.00 ; JPN

1/0 PCB Connect OK namco ltd.
TSS-I/O;Ver2.02;JPN;GUN-EXTENSION

EXIT
SELECT SW : CHOOSE   ENTER SW : ENTER
```



### 6-3-3-2 Gun Initialize

1. Select 'GUN INITIALIZE' from the I/O Test Screen. The following screen is displayed:-

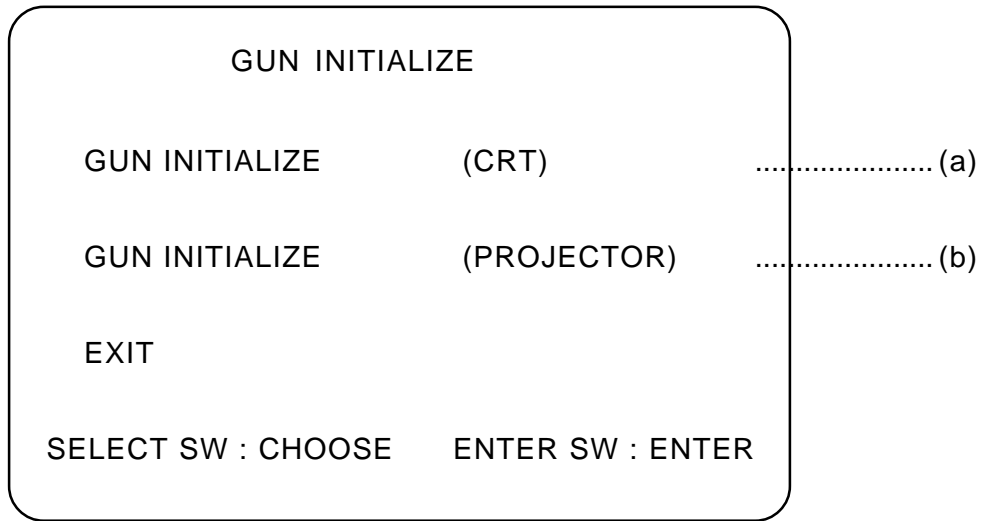

2. Use the Up/Down switch to select 'GUN INITIALIZE (PROJECTOR)', and press the Enter switch. The following screen is displayed.

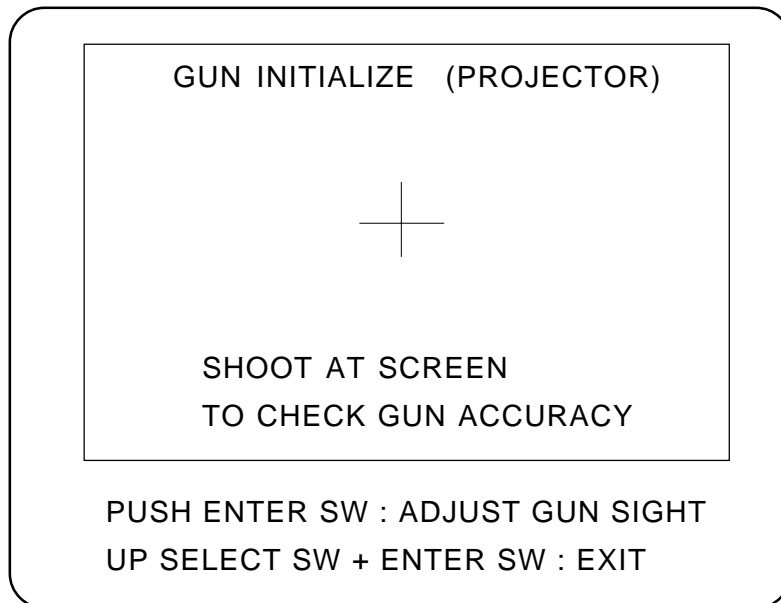

3. This screen allows the gun accuracy to be checked. Shoot the gun at the screen. The screen will display the position of the bullet. If the position is not where the gun was aimed press the 'Enter sw' or press on the pedal. The following screen will be displayed.

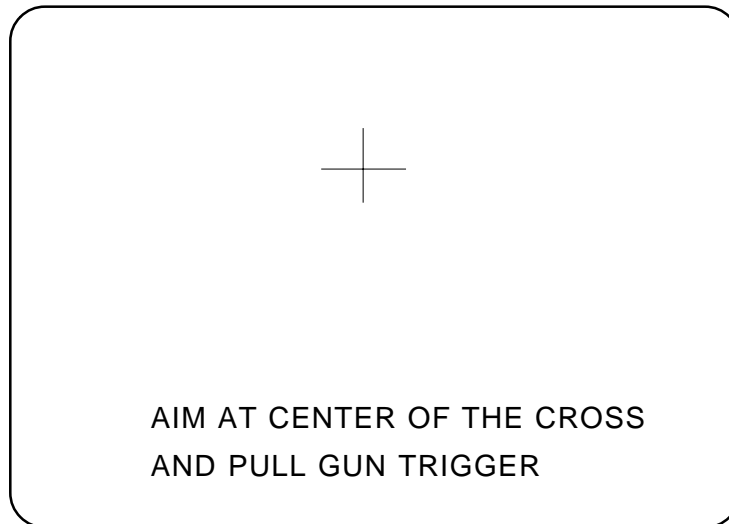

4. The gun aim is set by aiming and shooting at three points on the screen: the middle, top and bottom.
5. While the above screen is displayed, aim at the centre of the cross displayed in the middle of the screen. After firing the gun the following screen is displayed.

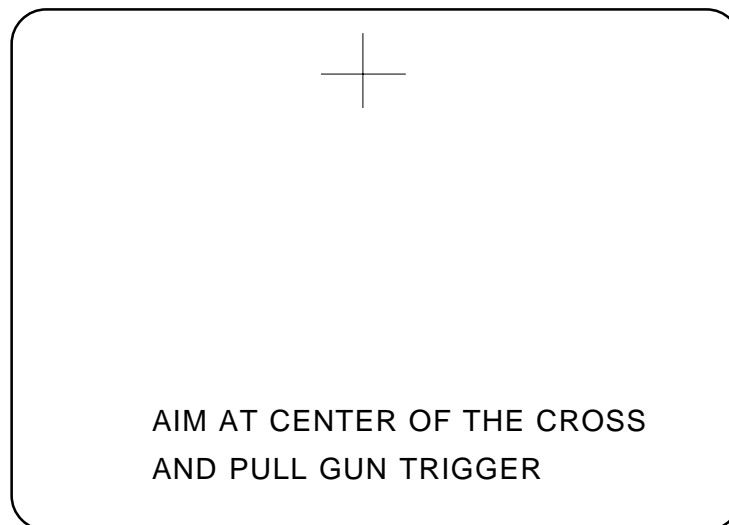

6. While the above screen is displayed, aim at the centre of the cross displayed at the top of the screen. After firing the gun the following screen is displayed.

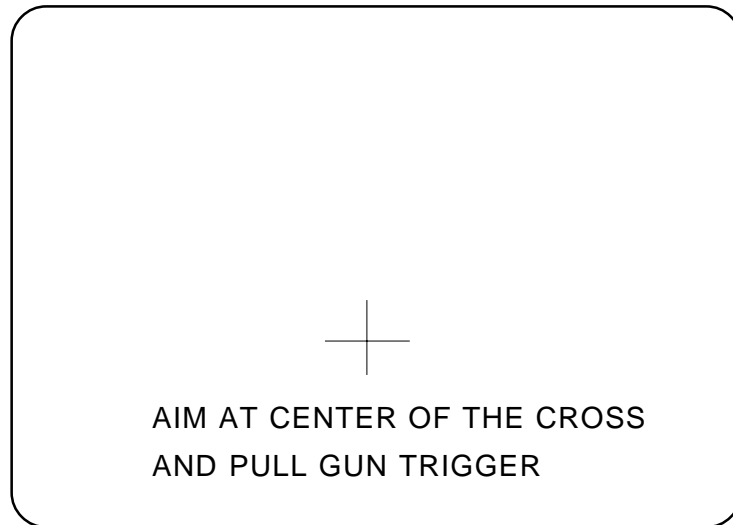

7. While the above screen is displayed, aim at the centre of the cross displayed at the bottom of the screen. After firing the gun aiming is now set, and the screen will return to the original 'Gun Initialize' screen.
8. Aim and fire the gun at the screen to check the new gun aiming. If the aiming is correct press the Up Select sw and Enter switch together to return to the 'I/O Test' screen. If the gun aiming is incorrect repeat steps 3 to 8.

### 6-3-3-3 Switch Test

1. Select "Switch Test" on the I/O menu screen to test the switches. The following screen is displayed.
2. The display shows the current state of the switches.
3. Press the Up Select switch and the Enter switch together to EXIT and return to the I/O menu screen

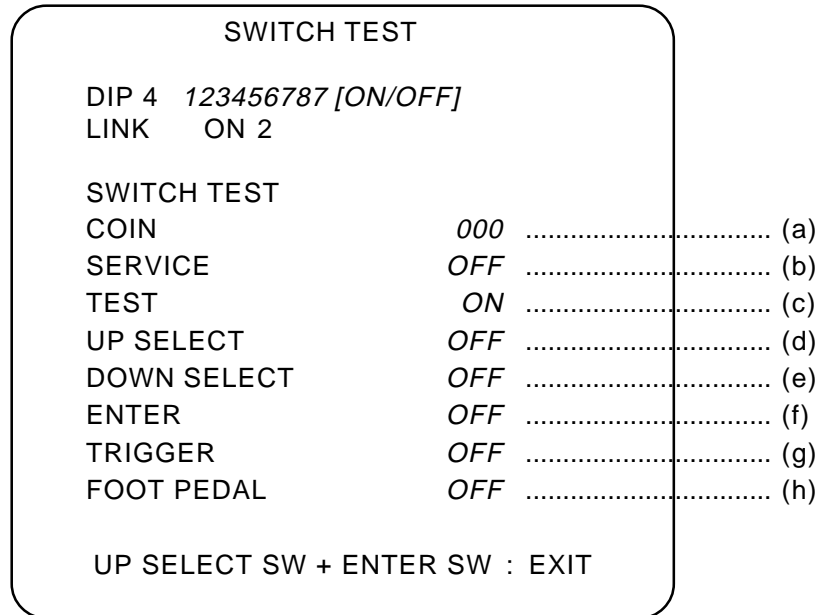

- (a) Not Used
- (b) The display will change from OFF to ON as each switch is operated.
- (c) The game will return to normal play mode if this switch is turned off.
- (d to h) The display will change from OFF to ON as each switch is operated.

#### 6-3-3-4 Solenoid Test

1. Select "solenoid Test" on the I/O menu screen to test the switches. The following screen is displayed.

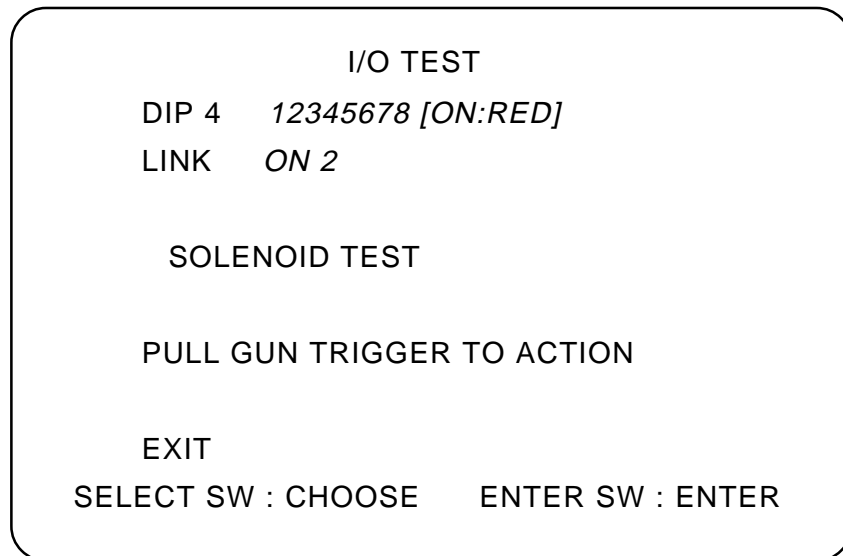

2. The gun recoil solenoid will operate each time the trigger is pressed.
3. Select 'EXIT' and press the Enter button to return to the I/O menu screen.

### 6-3-4 Monitor Test

1. Select "MONITOR TEST" on the menu screen to test and adjust the Monitor. The following screen is displayed.
2. Use the Select Up/Down switch to choose the required item then press the Enter button. To return to the Monitor Test Menu from a test pattern press the Enter button.
3. Select "EXIT" and press the Enter button to return to the menu screen.

MONITOR TEST	
GRADATION PATTERN	..... (a)
CROSSHATCH PATTERN (CRT)	..... (b)
CROSSHATCH PATTERN (PROJ)	..... (c)
WHITE WINDOW (H)	..... (d)
WHITE WINDOW (M)	..... (e)
WHITE WINDOW (L)	..... (f)
INTERLACE PATTERN	..... (g)
VIEW ANGLE ADJUST (CRT)	..... (h)
VIEW ANGLE ADJUST (PROJ)	..... (i)
FULL WHITE	..... (j)
EXIT	
SELECT SW : CHOOSE ENTER SW : ENTER	

*Note:*

*Items (b) and (h) are not used on this game.*

### 6-3-5 Sound Test

1. Select "I/O TEST" on the menu screen to switches and lamps. The following screen is displayed.
2. Use the Select Up/Down switch to choose the required item then press the Enter button.
3. Use the Up/Down switch to change the setting.
4. Press the Enter button after the changes have been made to return to the options.
5. Select "EXIT" and press the Enter button to return to the menu screen.

SOUND TEST			
<DEFAULT IN GREEN>			
VOLUME	FRONT L SP	(0~64)	40 ..... (a)
	FRONT R SP	(0~64)	40 ..... (b)
REQUEST	SONG NO.		000 ..... (c)
MESSAGE			..... (d)
EXIT			
SELECT SW : CHOOSE    ENTER SW : ENTER			
SERVICE SW : REQUEST ON/OFF			

- (a) Volume setting for left channel speaker. Settable from 0 ~ 64 with 0 quietest and 64 loudest.
- (b) Volume setting for right channel speaker. Settable from 0 ~ 64 with 0 quietest and 64 loudest.
- (c.) Each number will produce a different sound each time the Service button is pressed. (for a maximum of ten seconds)  
001 when selected will produce a sound from the left speaker only, then the right speaker only and then both speakers together as a stereo check. The message field shows which speaker is active.
- (d) Displays the song No. details.

### 6-3-6 ADS Data

By selecting ADS Data from the menu screen, all of the bookkeeping details can be read and/or reset.

### 6-3-7 Others

1. Select "OTHERS" on the menu screen. The following screen is displayed.
2. Use the Select Up/Down switch choose the required item then press the Enter button.
3. Select "EXIT" and press the Enter button to return to the menu screen.

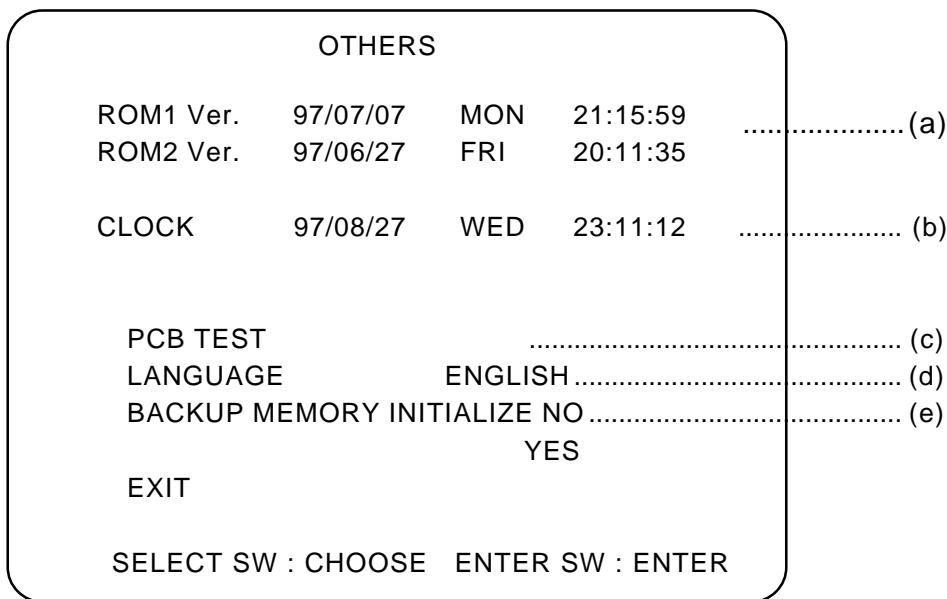

- (a,) Displays game software version.
- (b) Allows the internal clock and calendar to be set.
- (c) Used to test the PCB. (this function is only for factory testing)
- (d) Sets the language displayed on the screen:  
English : ENG  
German : GER  
French : FRA  
Spanish : SPA  
Portugese : POR  
Italian : ITA
- (e) When selected the Data Initialization Menu appears. To reset all game settings to factory setting and clear all stored data , select YES from the Data Initialization menu then press the Enter button.

**NOTE:** *The game will not function correctly unless the software version is the same for both players.*



## 7. REMOVING AND REPLACING ASSEMBLIES AND PARTS

### 7-1 Removing the Monitor from the Monitor Base

**The monitor is heavy. approx 100kg  
At least five (5) people are required to remove the monitor.**

1. Remove the 4 off pozi head screws (M5x35) and remove the front cover.
2. Disconnect the two connectors and then remove the 2 off hex head screws (M10x130), spring washers and square flat washers

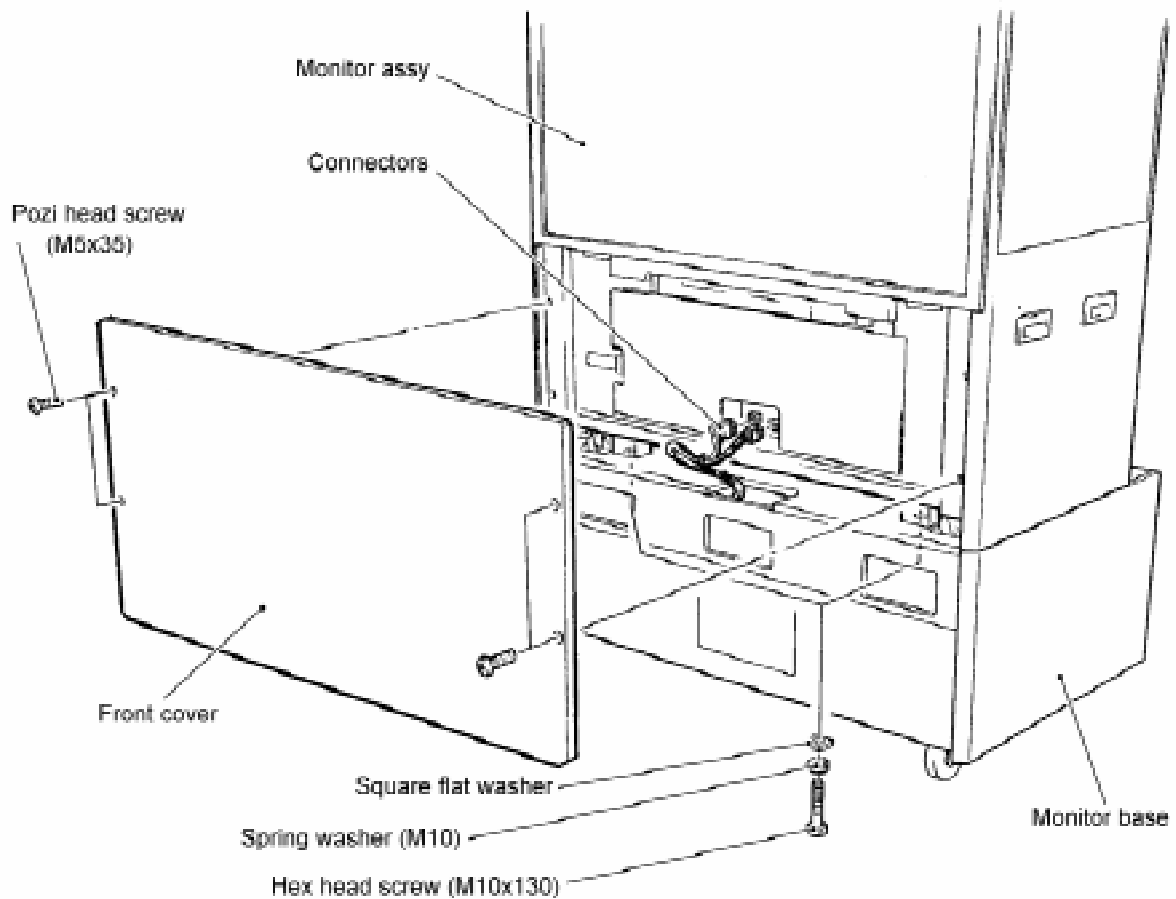

3. Remove the 2 off pozi head screws (M5x30) and remove the cover strip.
4. Remove 2 off pozi head screws (M5x30), unlock and remove the rear door.
5. Remove the 2 off hex head screws (M10x130), spring washers and square flat washers.

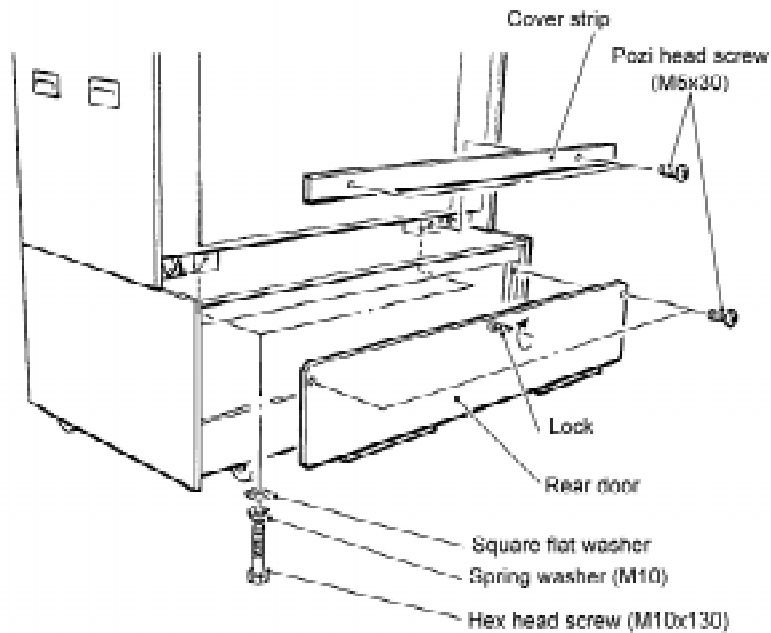

6. Lift the Monitor approx 10cm from the monitor base and then move it forwards or backwards clear of the monitor base.

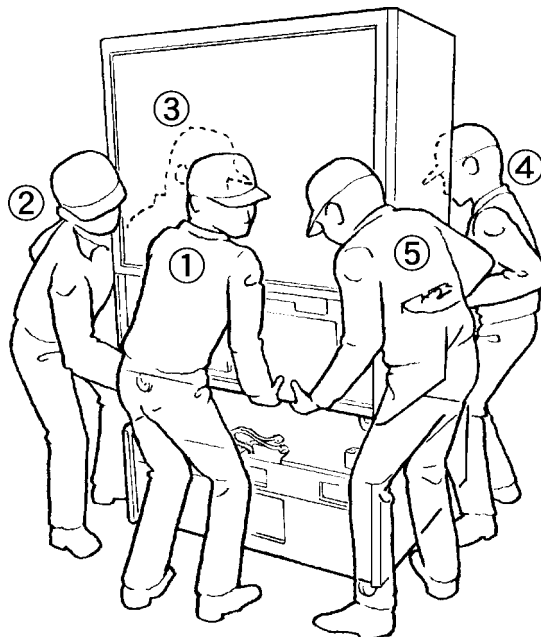

*Note: When placing the monitor on to the floor or replacing on to the monitor base, take care not to trap hands or fingers.*

## 7-2 Replacing the Fluorescent Tube or Starter

1. Remove 4 off tork screw (M5x15) and remove the top retaining bracket and header acrylic.
2. Replace the fluorescent tube or starter.
3. Refit the header acrylic and top retaining bracket.

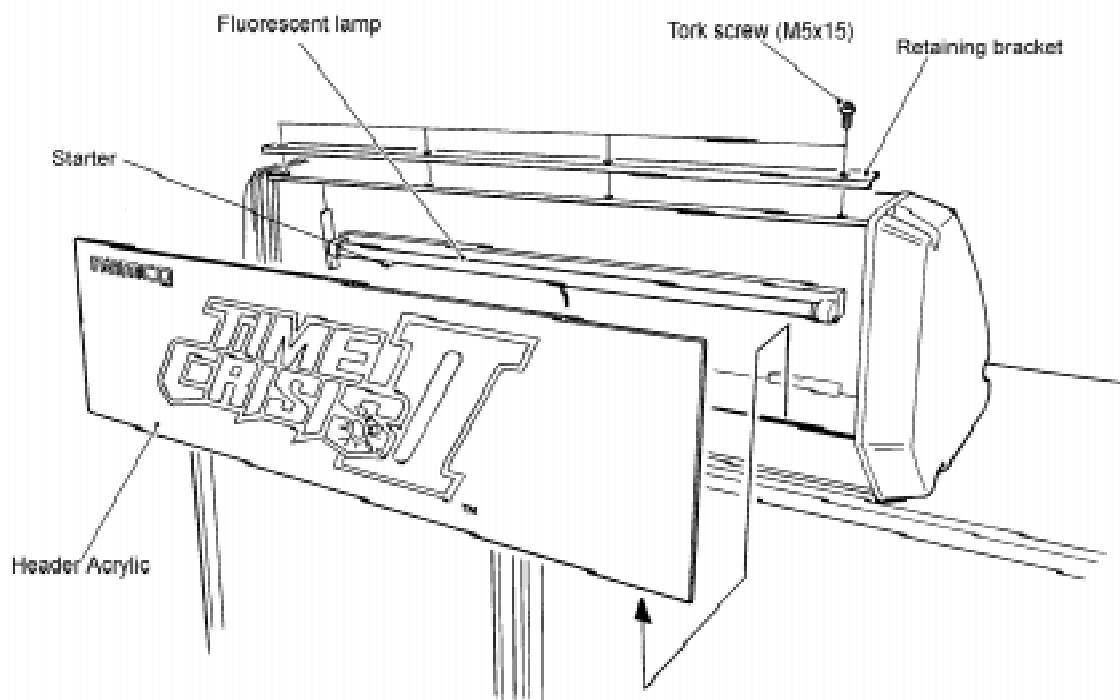

### 7-3 Replacing the Pedal Switch

1. Remove 4 off security screw (M5x12) and remove the switch cover plate.

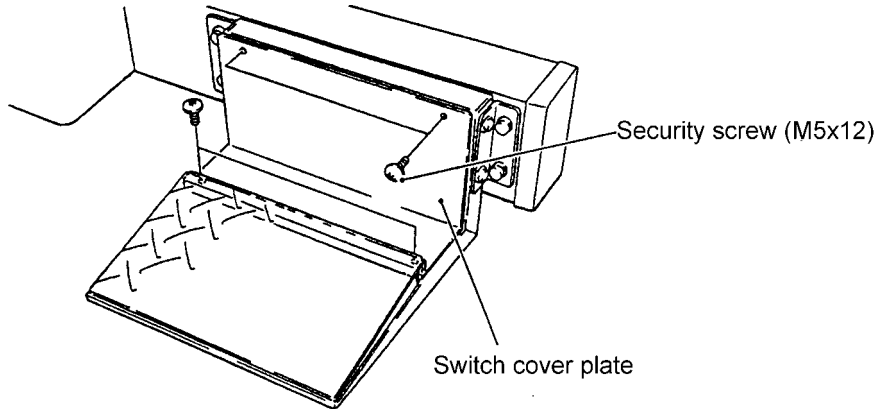

2. Remove 2 off pozi head screw (M3x16) and remove the switch. *When replacing the switch, ensure that the wires are fitted to the correct terminals.*

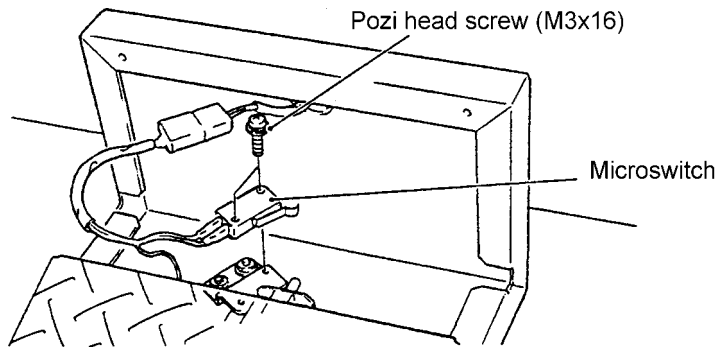

3. Slacken the 2 off whizztite nuts (M4) and adjust the microswitch bracket so that the switch plunger operates the switch correctly without bending the switch lever against the switch body.

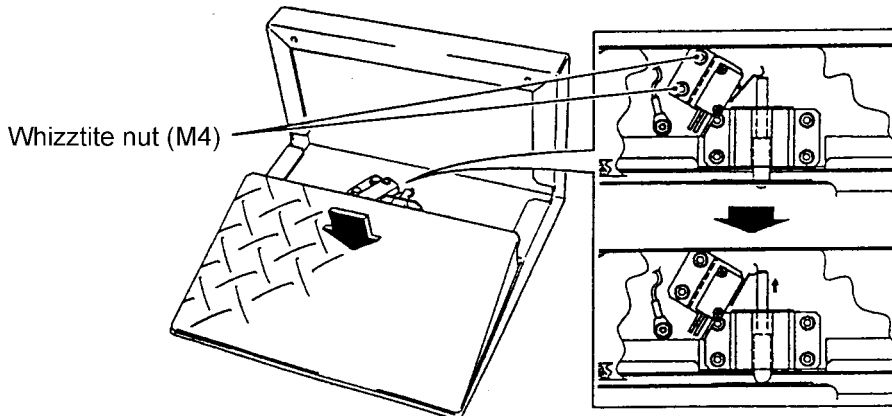

4. Refit the switch cover plate and 4 off security screw (M5x12).

## 7-4 Greasing the Pedal Assy Plunger

1. Remove 4 off security screw (M5x12) and remove the switch cover plate.

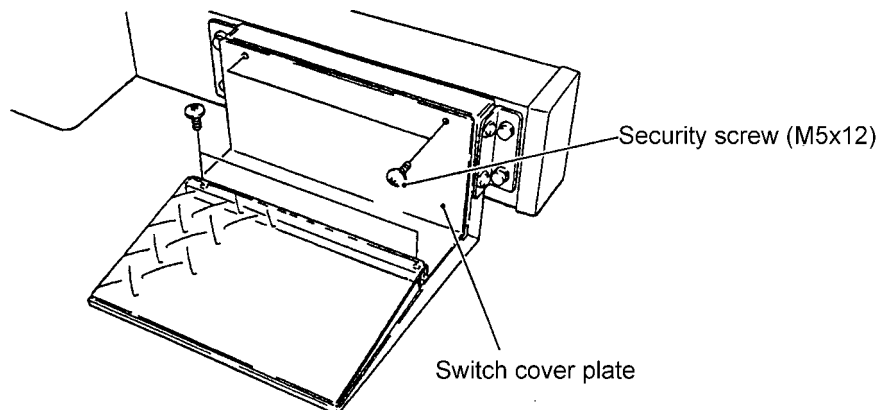

2. Remove 2 off whizztite nuts (M4) and remove the switch.
3. Remove 4 off whizztite nuts (M4) and remove the plunger assembly.  
*Note: The plunger is spring loaded. Keep the plunger pressed in when removing the assy and release the plunger slowly.*
4. Remove any old grease and dirt from the plunger and pedal plate.
5. Grease both the plate and spherical portion of the plunger.

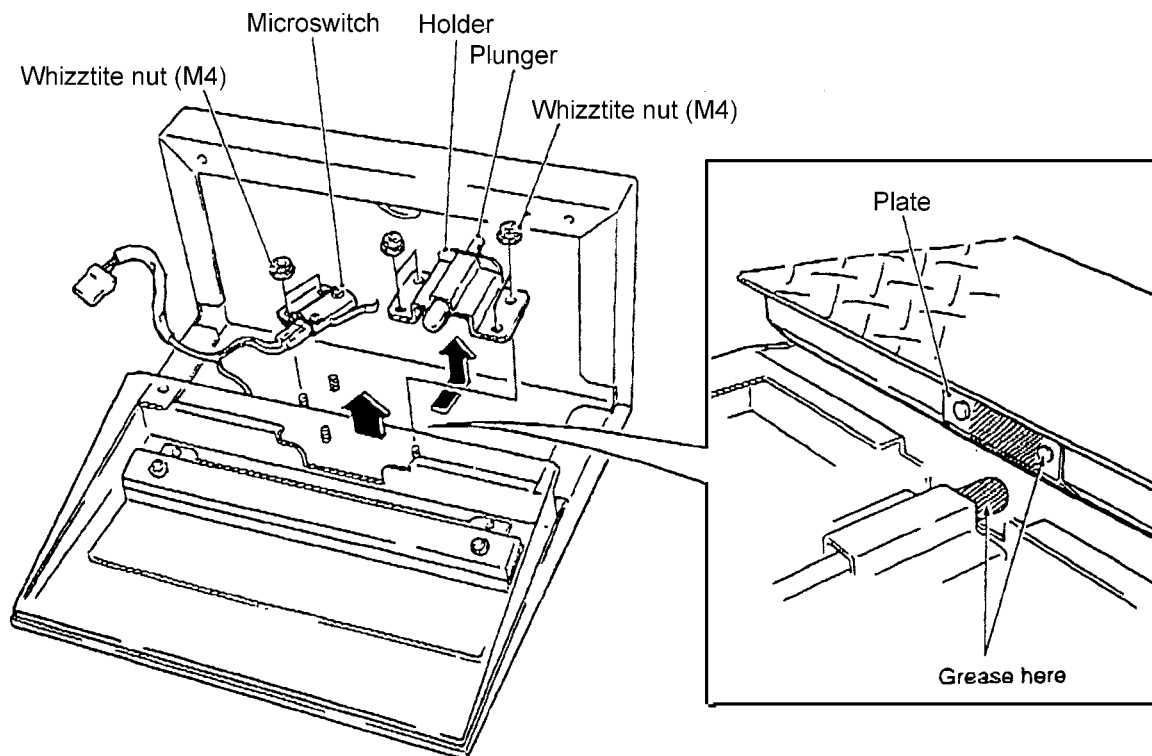

6. Reassemble in reverse order.

## 7-5 Replacing the Pedal Plunger

1. Remove the plunger assembly. (See 7-4 page 61)
2. Pull the plunger out of the holder. Replace with the new plunger. (The new plunger should have grease applied all over prior to fitting).

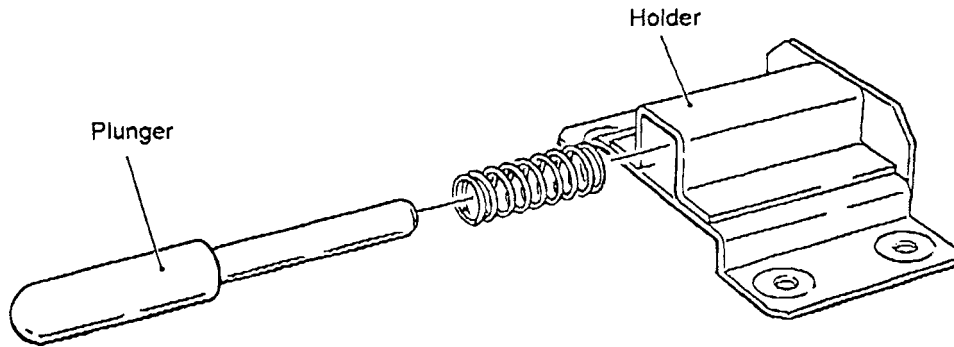

3. Wipe off any old grease and dirt from the pedal plate and regrease.

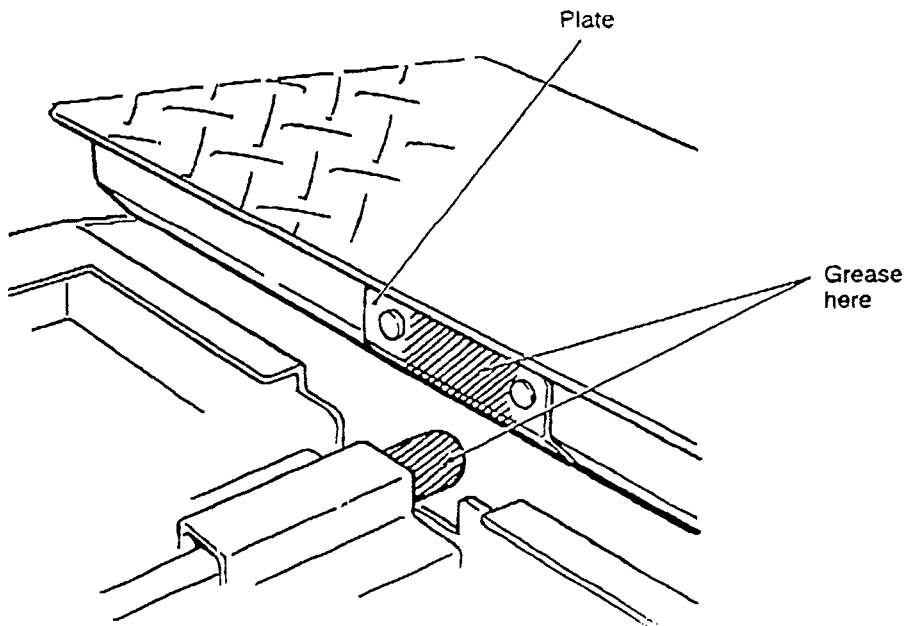

4. Reassemble in reverse order.

## 7-6 Gun Assembly

### 7-6-1 Replacing the Gun Assembly

1. Remove 8 off security screws (M8x20) and remove the gun pod complete with the gun.

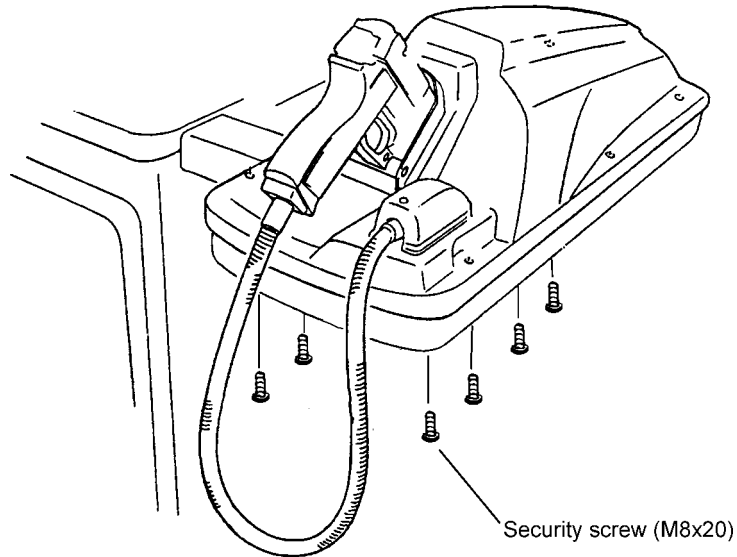

2. Disconnect the connectors and remove the 2 off whizztite nuts (M6).

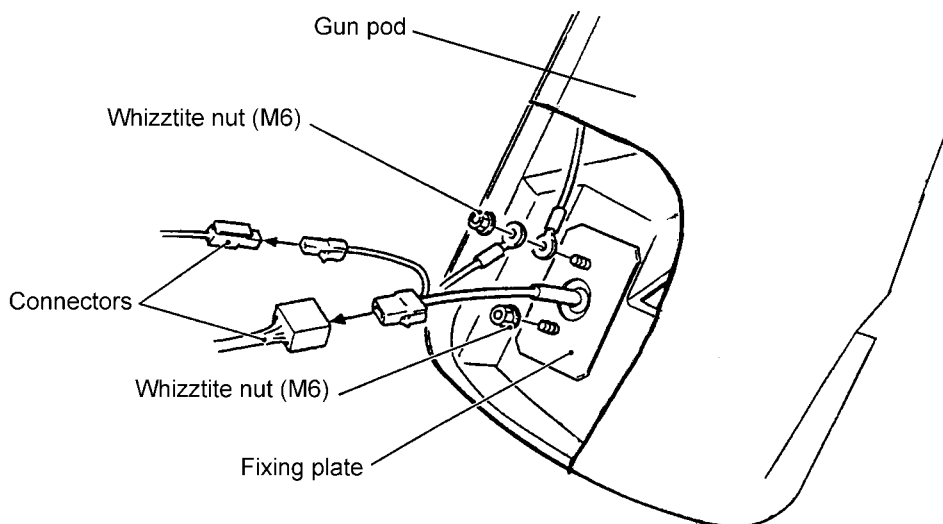

3. Remove the gun assembly from the gun pod.

**Note:** When replacing the gun assembly ensure that the earth wires are located on to the studs before fitting and tightening the whizztite nuts (M6)

## 7-6-2 Removing the Gun Slide

1. Remove 4 off cap screws (M3x10), 1 off button bolt (M4x25), and 1 off hex nut (M4), and detach the gun slides (L) and (R).
2. Reassemble in reverse order.

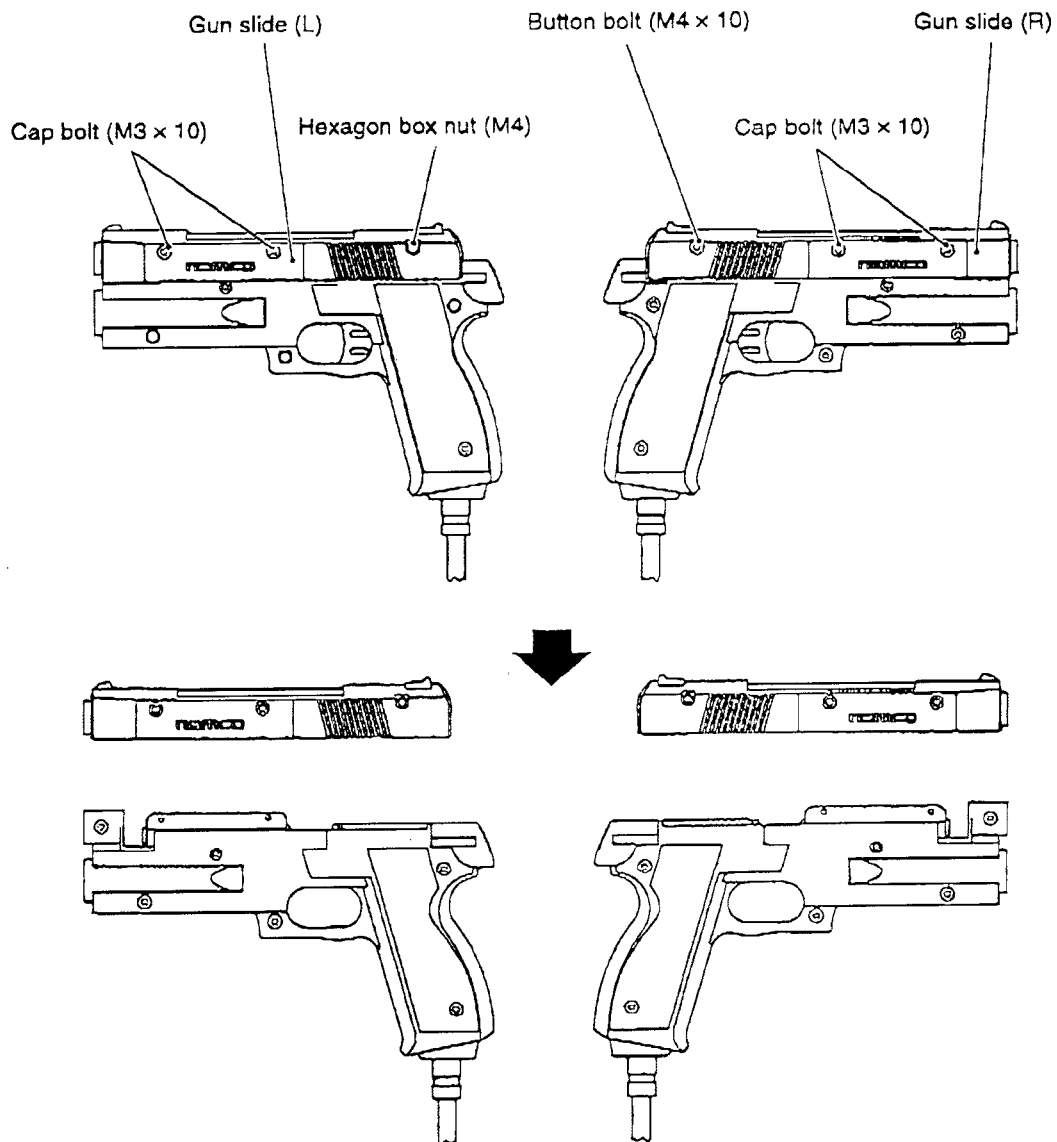



### 7-6-3 Removing the Gun Cover

1. Remove the gun slides (L) and (R). (See 7-6-2 page 64)
2. Place the gun (L) face down, and remove the 4 off button screws (M4x10), 1 off button screw (M4x25), 4 off hex nuts (M4), and 1 off cap screw (M3x10). Remove the gun cover (R) taking care that the lens does not fall out.

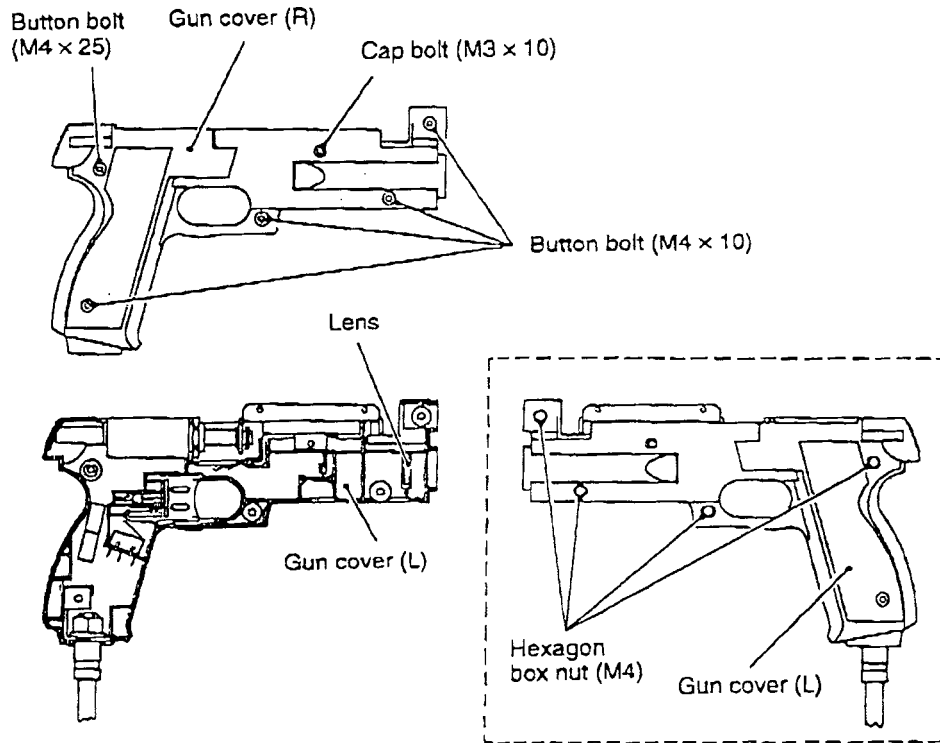

3. Reassemble in reverse order. (Ensure that the flat face of the lens is facing the back of the gun).

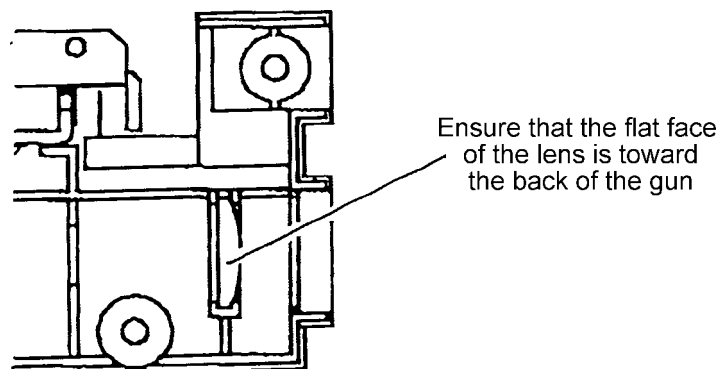

## 7-6-4 Replacing the Solenoid

1. Remove the gun cover and gun slide (R). (See 7-6-2 page 64 and 7-6-3 page 65)
2. Disconnect the solenoid connector.
3. Remove 1 off cap screw (M3x10) on the gun cover (L) and remove the solenoid bracket.
4. Remove 1 off cup screw M (M3x8) and detach the earth wire.
5. Loosen the nuts (16mm dia.) and remove the solenoid.
6. Remove 2 off cup screws M (M4x6) and detach the slide guide.
7. Pull out the solenoid plunger, taking care not to lose the spring.

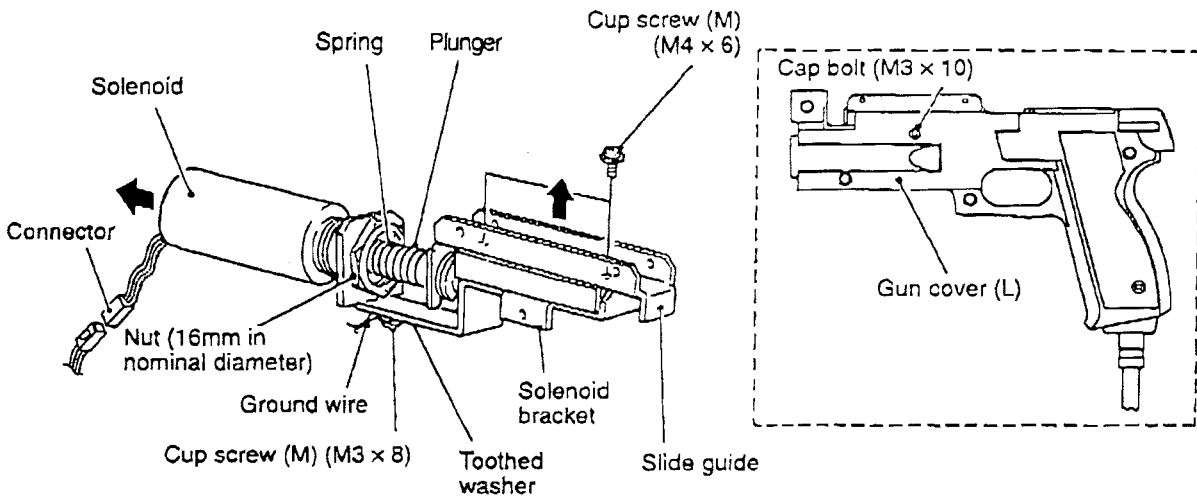

8. Reassemble in reverse order.  
*Note: When reassembling match the D-type hole of the solenoid bracket to the D shape of the solenoid and ensure that the 'E' ring and spacers are in the correct positions.*

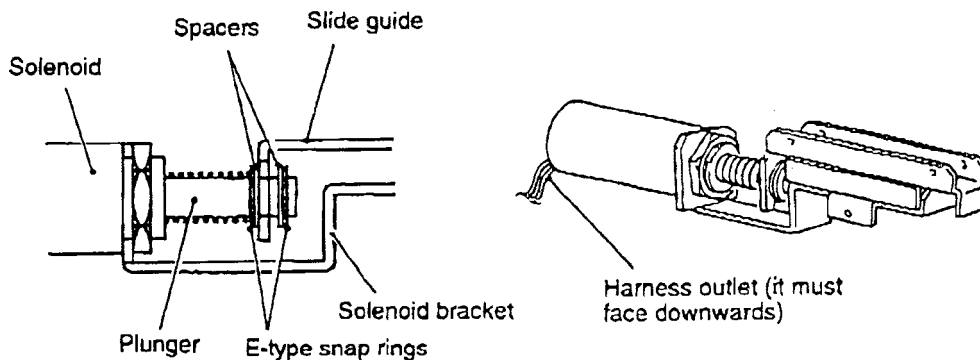

### 7-6-5 Replacing the Trigger Switch

1. Remove the gun cover and gun slide (R). (See 7-6-2 page 64 and 7-6-3 page 65)
2. Replace the microswitch. Take care when replacing the switch that the correct wires are fitted to the correct terminals.
3. Reassemble in reverse order.

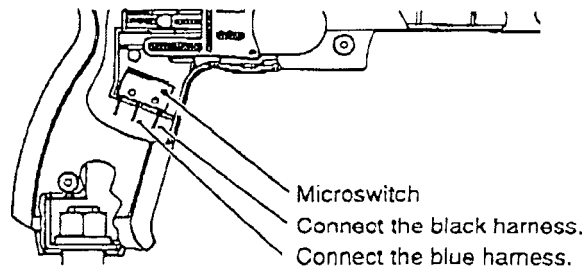

### 7-6-6 Replacing the Flexible Gun Conduit.

1. Remove the gun assembly. (See 7-6-1- page 63).
2. Remove the 2 off security screws (M4x10), then detach the connector cover.
3. Remove the gun cover and gun slide (R). (See 7-6-2 page 64 and 7-6-3 page 65).
4. Detach the solenoid bracket and detach the solenoid connectors and earth wire. (see 7-6-4 page 66).
5. Disconnect the sensor and detach the fast-on connectors from the micro switch.
6. Remove the button head screw (M4x10) fixing the conduit to the gun cover (L) and detach the conduit.
7. Reassemble in reverse order.

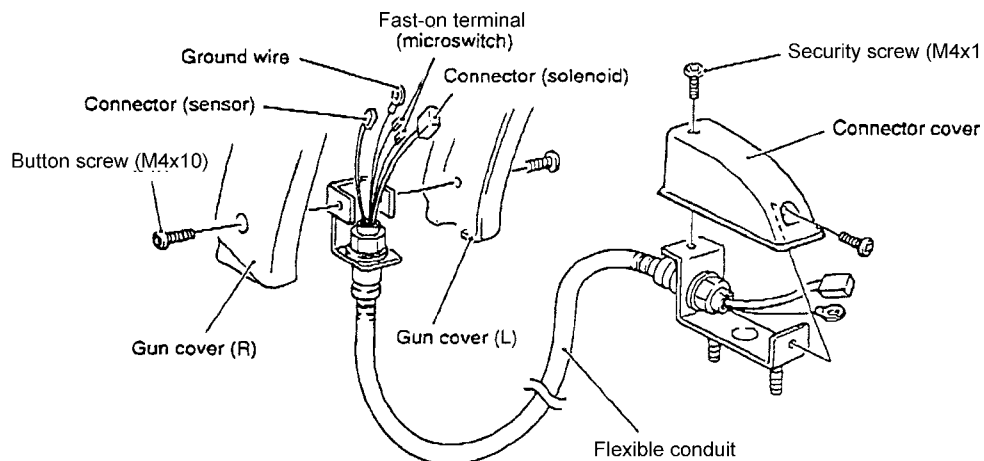

## 8. PARTS

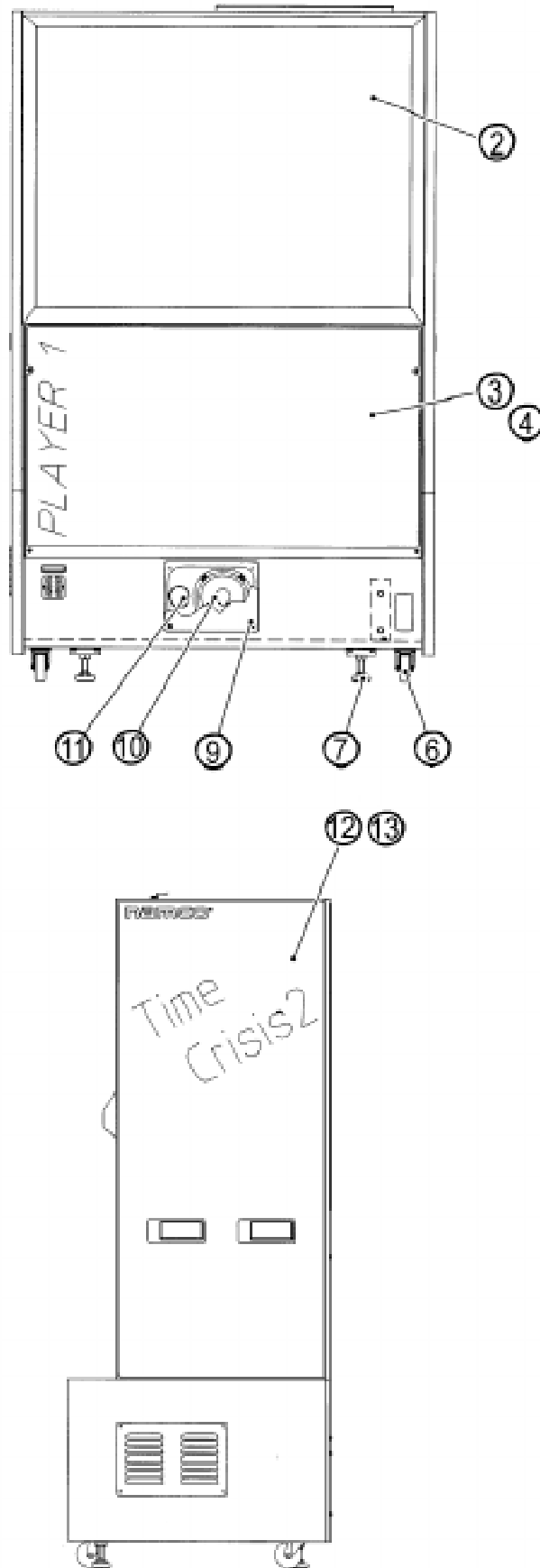

Item	Description	Part No
2	Pioneer 50" Projection Monitor - JVS	84000000
3	Projector Cabinet (LHS) Front Decal	40000257
4	Projector Cabinet (RHS) Front Decal	40000285
6	Swivel Castor - 75mm	59000005
7	Adjustable Foot - M16 x 95	88300079
9	Bass Loudspeaker Grille	46000828
10	Bass Loudspeaker - Pioneer SWM 1034	X006-115
11	Bass Loudspeaker Port	46000837
12	Projector Cabinet Side Decal (RHS)	40000253
13	Projector Cabinet Side Decal (LHS)	40000257

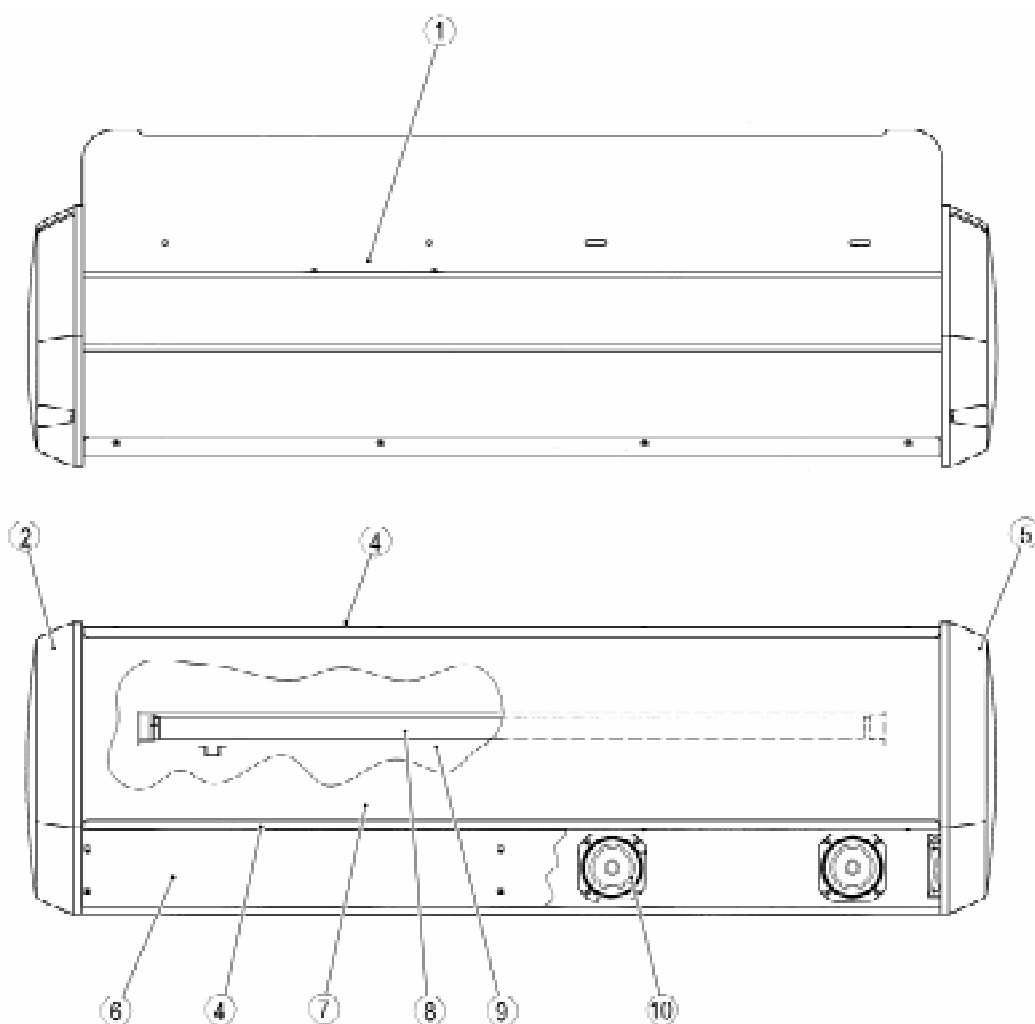

Item	Description	Part No.
1	Header Rear Closing Plate	46000866
2	Header Vac-Form (LHS)	46000863
4	Header Acrylic Closing Bracket	46000840
5	Header Vac-Form (RHS)	46000864
6	Loudspeaker Mesh	46000865
7	Header Acrylic	30000023
8	Fluorescent tube 4'	64500039
9	Fluorescent Assembly 4'	64000045
10	Loudspeaker 4%" 20watt	62000006

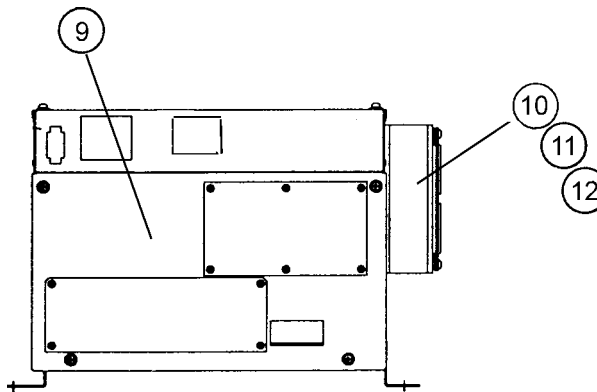
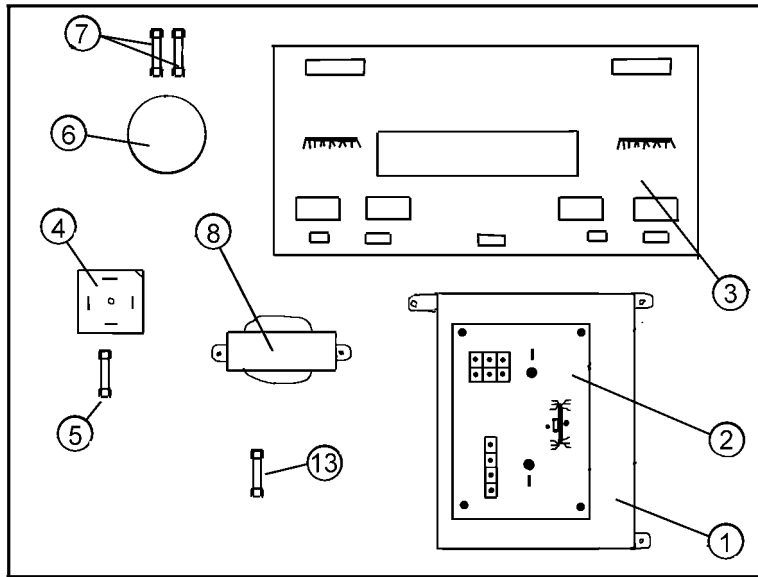

Item	Description	Part No
1	Switchmode Power Supply - 5v @ 32A	83000008
2	3v3 7A Converter	83000003
3	Amplifier PCB Assy	XTC2-AMPCB
4	Bridge Rectifier	71000040
5	Fuse 1..." 2A Q/B	63500504
6	Capacitor 22,000 F 25v	70200043
7	Fuse1..." 500mA Slo-Blo	63500637
8	Transformer 18v @ 3A	67700015
9	Game PCB Assembly	XTC2-PCB
10	Fan 4%" 230v	67000015
11	Finger Guard	39000169
12	Fan Gasket	46000724
13	Fuse 1..." 1A Q/B	63500424

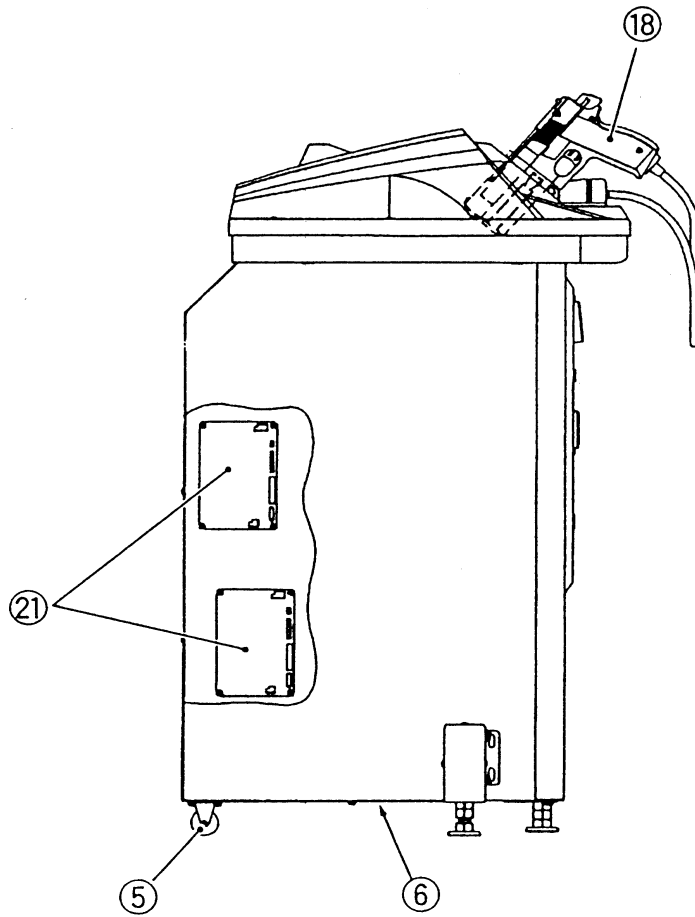
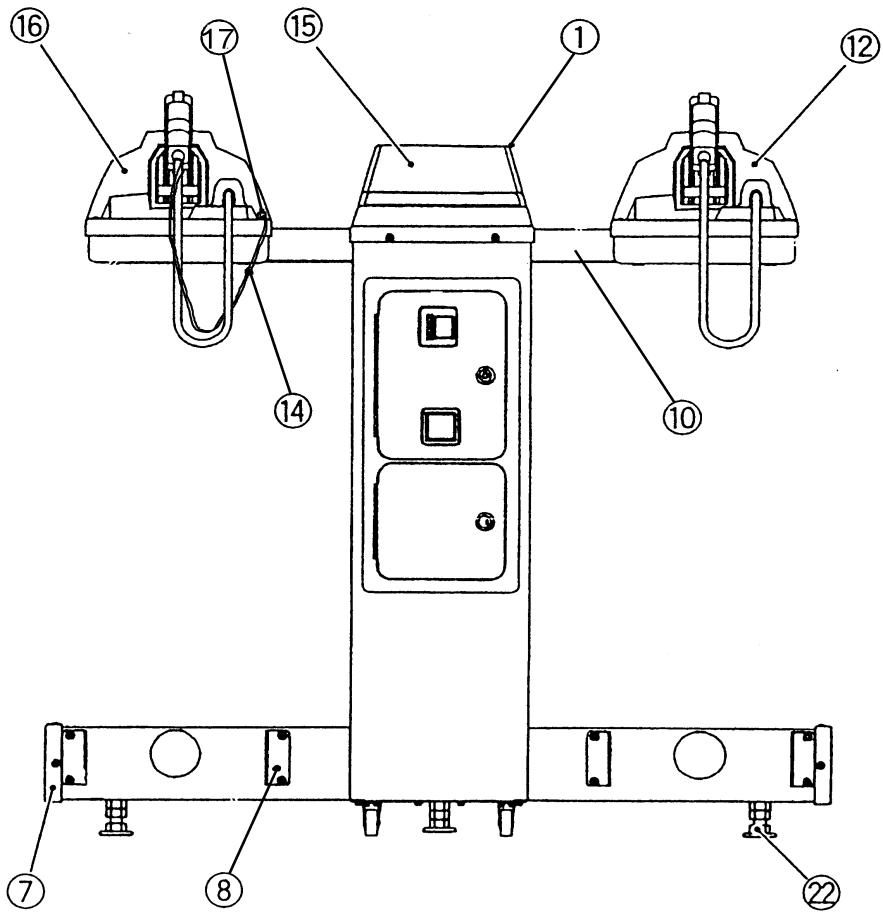



Item	Description	Part No
1	Coin Tower Top Vac-Form	46000850
5	Swivel Castor - 40mm	59000003
6	Coin Tower Underside Cover	46000849
7	Pedal Mounting Bracket - End	46000854
8	Pedal Mounting Bracket - Centre	46000852
10	Gun Station Support Rail	46000847
12	Rotary Moulded Gun Station - Blue	46000844
14	Strain Relief Rope	45000708
15	Play Instruction Decal - A	40000252
16	Rotary Moulded Gun Station - Red	46000845
17	Relief Rope Gun Hoop	45000210
18	Gun Assembly - Blue	XPB-Gun-Blue
	Gun Assembly - Red	XPB-Gun-Red
21	I/O PCB Assy	XTC2-IOPCB
22	Adjustable Foot - M16x95	88300079

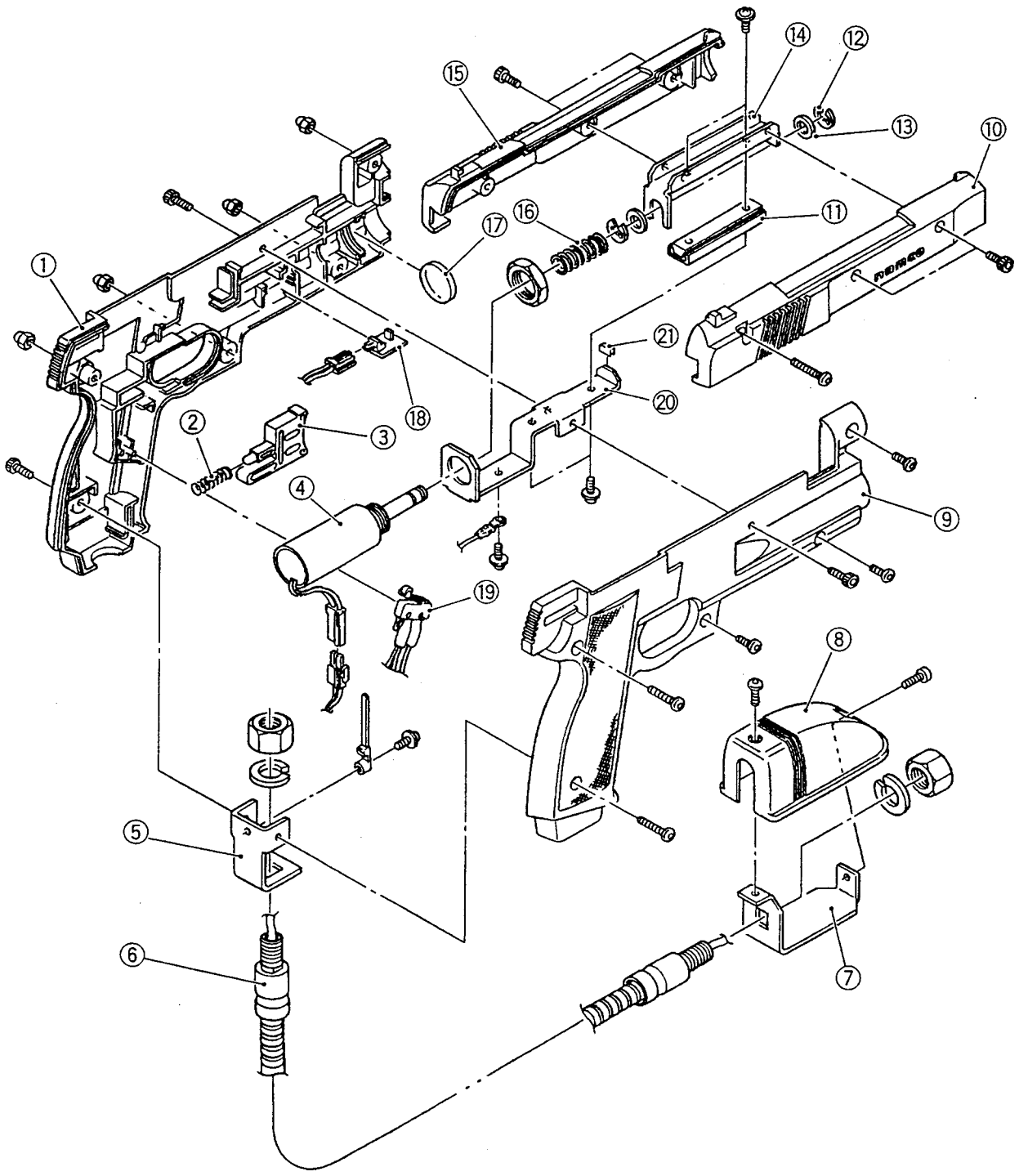

Item	Description	Part No
	Gun Assembly - Red	XPB-Gun-Red
	Gun Assembly -Blue	XPB-Gun-Blue
1	Gun Cover (LHS) - Red	XPB-Cover-LR
	Gun Cover (LHS) - Blue	XPB-Cover -LB
2	Trigger Spring	XPB-296-421
3	Trigger - Red	XPB-Trigger-R
	Trigger - Blue	XPB-Trigger-B
4	Solenoid - ST-0860A2	XPB-004-056
5	Tube Bracket (A)	XPB-296-418
6	Gun Cord Harness Assy	XPB-296-401
7	Tube Bracket (B)	XPB-296-423
8	Connector Cover	XPB-296-424
9	Gun Cover (RHS) - Red	XPB-Cover-RR
	Gun Cover (RHS) - Blue	XPB-Cover RB
10	Gun Slide (RHS) - Red	XPB-Slide-RR
	Gun Slide (RHS) - Blue	XPB-Slide RB
11	Slide Rail E20+F15R2/60L	XPB-296-425
12	E-type Snap Ring 7CR-3 (10dia)	XPB-Eclip
13	Spacer	XPB-296-422
14	Slide Guide	XPB-296-417
15	Gun Slide (LHS) - Red	XPB-Slide-LR
	Gun Slide (LHS) - Blue	XPB-Slide -LB
16	Back Spring	XPB-296-420
17	Lens NA-V1472050	XPB-296-426
18	Sensor PCB	XPB-296-467
19	Microswitch SS-01GI2T	XPB-000-228
20	Solenoid Bracket	XPB-296-416
21	Silencer Rubber	XPB-296-428

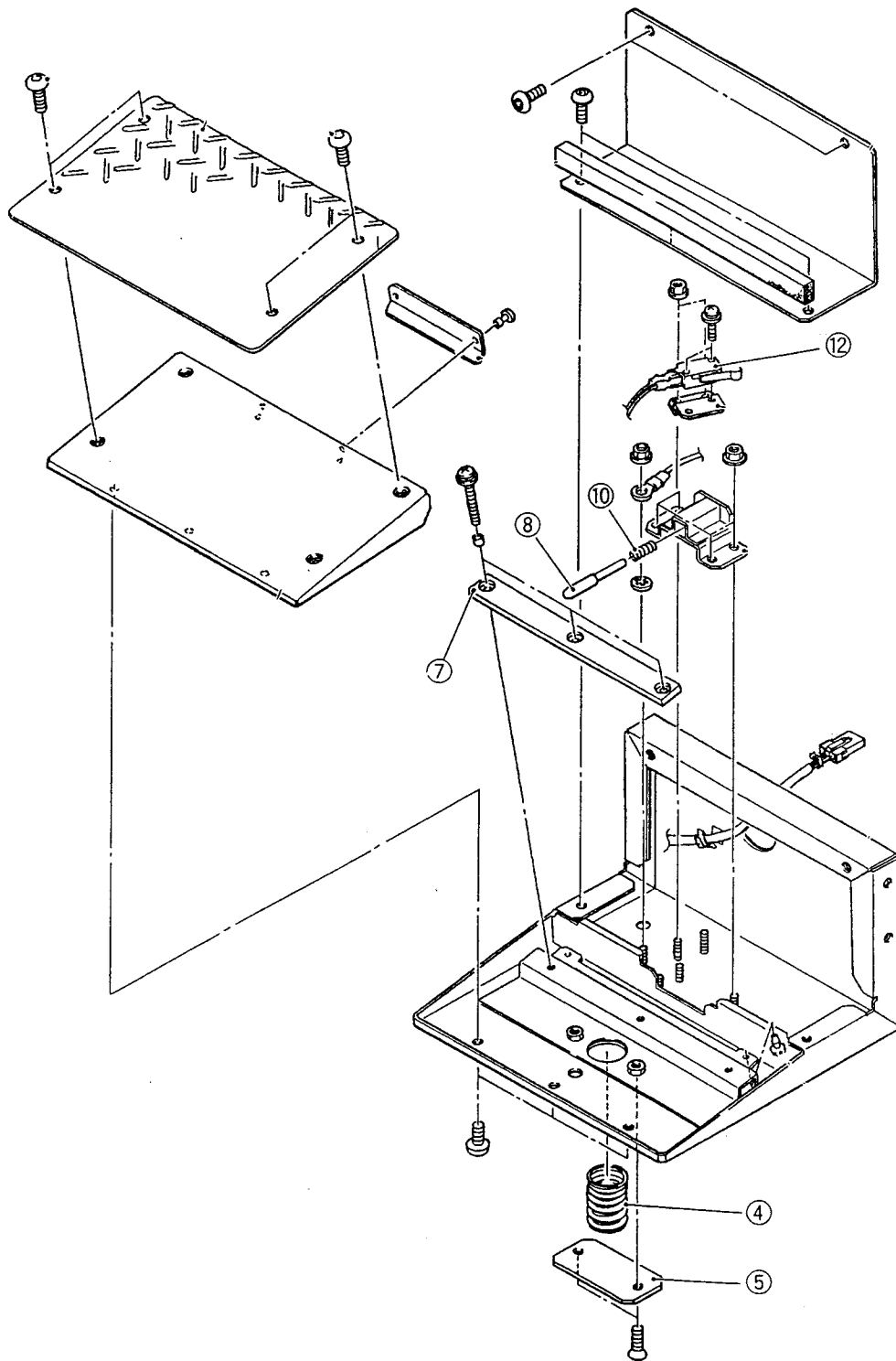

Item	Description	Part No.
4	Spring (A)	XTC-631-221
5	Spring Cover	XTC-631-218
7	Rubber Stopper	XTC-631-217
8	Plunger	XTC-631-219
10	Spring (B)	XTC-631-222
12	Microswitch - KSL 13	XTC-000-027

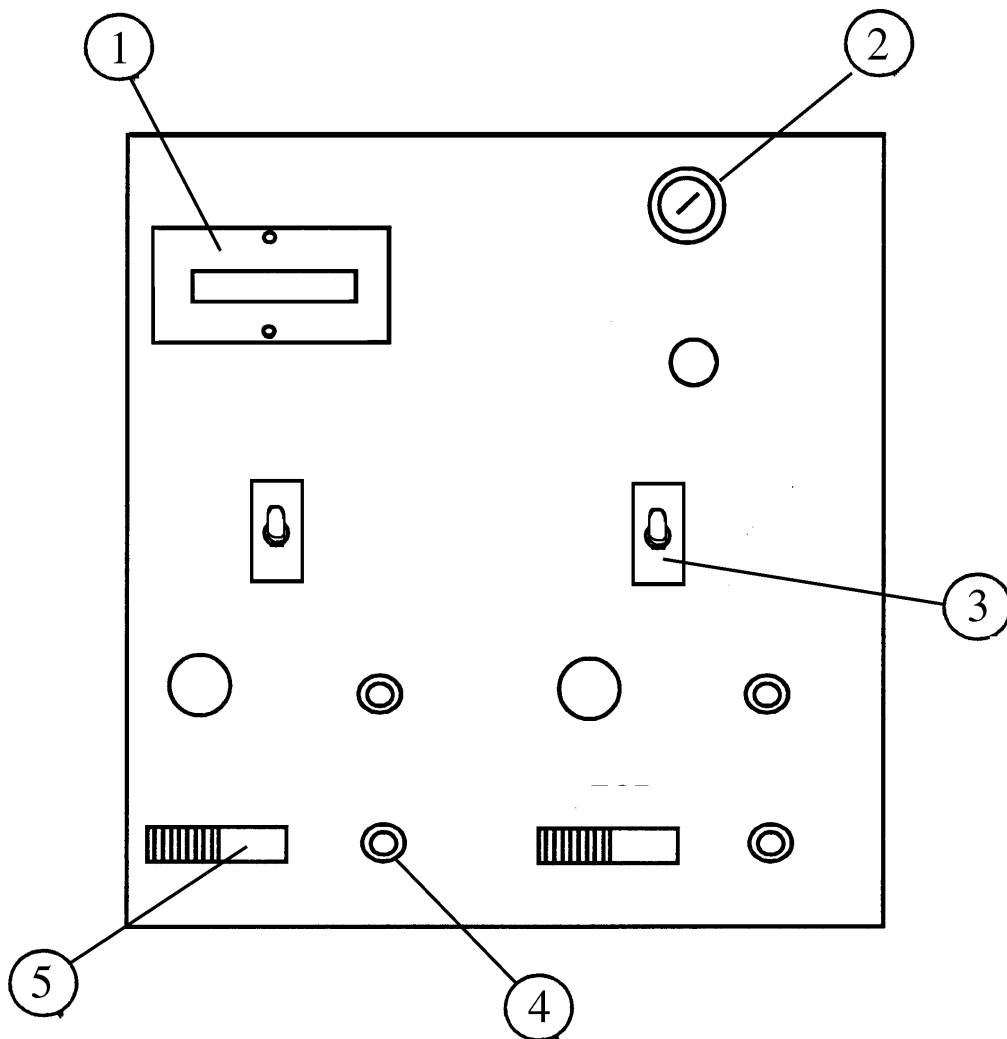

Item	Description	Part No
1	3.5~6v Panel Mount Meter	65000002
2	20mm Panel Mount Fuseholder	63500786
	Fuse 20mm 2A Q/B	63500501
3	SPDT Toggle Switch -(momentary action)	60000010
4	Pushbutton Switch 7mm - Red	60000059
5	Miniature Slide Switch	60000023



