

MIDWAY

STRIKE FORCE™ KIT

OPERATIONS MANUAL

including:

**Installation & Operation
Testing & Problem Diagnosis
PC Board Parts Information
Reference Diagrams & Schematics**

MIDWAY MANUFACTURING
3401 N. California Avenue
Chicago, IL 60618

The Saga of STRIKE FORCE

In the year 2020 the first alien contact is made. From the farthest reaches of the galaxy comes a distress call. The Saurians, an evil reptilian race bent on conquering the universe, are currently invading the human colonized Beta System. The Saurians mutate all life forms they encounter into slaves for their evil empire. The only hope for the colonists and, perhaps, all of mankind is an elite team of fighters able to respond to the initial invasion.

Each player controls a Strike Force composed of a rocket fighter and a team of space marines in their powered battle armor. They must travel throughout the planets of the Beta System, battling the Saurians and their vicious minions. Unfortunately, defeating the Saurians on the planets surface is not enough. The Saurian megastar, which brought the alien invaders, is circling the solar system launching dreadnaughts. These large dangerous motherships travel to the planets delivering a never- ending supply of invading Saurians. The players need to destroy the dreadnaughts to prevent the retaking of their hard won planets. Ultimately though, they must attempt the destruction of the Saurian Megastar "Apocalypse" to end the invasion and win on the Saurian Front.

STRIKE FORCE Game Play

STRIKE FORCE is a one, or two-player game in which two players play simultaneously. Unlimited buy-ins are allowed at any time for either player. STRIKE FORCE is unique because it has unlimited open ended game play and an ultimate goal, which allows the players to win. Most games provide the player with a fixed series of encounters that do not change from game to game, STRIKE FORCE puts the player in charge of battling his/her way through a realistic environment. The player not only chooses where to go across a 3D- looking planetary surface, but also which weapon to use from an arsenal that accumulates as the game progresses. Once the Saurians are conquered on a planet, the player pilots his/her interplanetary shuttle to one of 22 different planets.

The Megastar is 40 screens long. The ultimate challenge of STRIKE FORCE is to chase down, enter, and get to the core of the enemy Megastar.

STRIKE FORCE

TABLE OF CONTENTS

Section 1 Installation and Operation

Safety	1-2
Conversion Procedure	
Inspection	1-3
Recommended Tools and Supplies	1-3
Cabinet Modifications	1-4
Control Panel Modifications	1-4
Typical Control Panel Layout	1-5
Installing PC Boards & Wiring into a JAMMA Cabinet	1-6
Installing PC Boards & Wiring into a non-JAMMA Cabinet	1-7
Installing the Volume Control	1-8
Game Features	
Start-up	1-9
Player Controls	1-9
Game Operation	
Control Switches	1-10
Control Switch Location Diagram	1-10
Game Audits, Diagnostics & Adjustments	
Operation	1-11
Game Audits	1-11
Audit Table	1-11
Diagnostic Tests	1-12
CPU Test	1-12
Burn-in Test	1-12
Monitor Test	1-12
DIP switch Test	1-12
Switch Tests	1-12
Game Adjustments	1-13
DIP switch 1	1-13
DIP switch 2	1-14
Troubleshooting	1-15

Section 2 PC Board Parts Information

CPU Board	2-2
CPU Parts	2-3
Sound Board & Parts	2-4

Section 3 Diagrams and Schematics

Sound Board Schematic	3-2
CPU Board Schematic	3-3
JAMMA Chart	3-19
Cabinet Wiring	3-20
Coin Meter Wiring	3-21
Interboard Wiring	3-22
Control Panel Wire Colors	3-23
Control Panel Template Diagram	3-25

S E C T I O N
one



INSTALLATION and OPERATION

Safety Notices

The following safety hints apply to all kit operators and service personnel. Specific warnings and cautions will be found throughout this manual where they apply. We recommend that you read this page, and also all of Section 1, before preparing your kit for play.

NOTICE: SALVAGED PARTS

Parts salvaged from old games are required to complete your kit. These salvaged parts must operate perfectly: otherwise, the converted game cannot perform properly or safely. Always repair circuit board malfunctions and cabinet damage before conversion is attempted.

NOTICE: POWER SUPPLY

Be sure the power supply from your old game is capable of +5V dc at 5A, -5V dc at 1A and +12V at 1A. These operating voltages are necessary for your kit. Your power supply must be FCC approved.

NOTICE: MONITOR

This kit is not intended for use with X-Y monitors. Suitable monitors have horizontally mounted CRTs and raster electronics with inputs for red, green and blue video, as well as Composite Negative Sync inputs.

NOTICE: COIN MECHANISM

Be sure to clean and lubricate your old coin mechanisms. Servicing them is crucial to your game's earning potential and operation.

NOTICE: COIN METERS

Coin meters are not provided with this kit. Wiring information is provided as a convenience to the operator.

NOTICE: SERVICING, INSTALLING

Always turn your game Off and unplug it before attempting to service or install your kit.

CAUTION

PROPERLY ATTACH ALL CONNECTORS. Be sure that the connectors on each printed circuit board (PCB) are properly connected. If they do not slip on easily, do not force them. A reversed connector may damage your kit and void the warranty. All connectors are keyed to fit specific pins on each board.

Conversion Procedure

Inspection

Unpack the materials from the carton and inspect for obvious signs of damage. Use this checklist to be sure your kit is complete.

Part No.	Item	Quantity
<input type="checkbox"/> A-13234-43313	CPU board	1
<input type="checkbox"/> A-13971-43313	Sound board	1
<input type="checkbox"/> C-9214-4	red pushbutton assy	2
<input type="checkbox"/> C-9214-22	purple pushbutton assy	3
<input type="checkbox"/> C-9214-23	yellow pushbutton assy	3
<input type="checkbox"/> H-8866	volume control cable	1
<input type="checkbox"/> H-12758	sound board jumper cable	1
<input type="checkbox"/> H-13257	sound power/speaker cable	1
<input type="checkbox"/> H-13411	main JAMMA cable	1
<input type="checkbox"/> 16-9201	controls template	1
<input type="checkbox"/> 16-43113-101	manual	1
<input type="checkbox"/> 20-9222	5/8 palnut	8
<input type="checkbox"/> 20-9319-4	yellow 8-way joystick	1
<input type="checkbox"/> 20-9319-6	purple 8-way joystick	1
<input type="checkbox"/> 20-9457	Wico buttonholder	8
<input type="checkbox"/> 31-1613-42413	kit marquee	1
<input type="checkbox"/> 31-1616-42413	cabinet side decal set	2
<input type="checkbox"/> 31-1620-42413	control panel overlay	1
<input type="checkbox"/> 31-1622-42413	control panel decal	1
<input type="checkbox"/> 5795-10937-18	20-pin ribbon cable	1
<input type="checkbox"/> assorted hardware		

Recommended Tools and Supplies

- black semi-gloss paint
- electric drill
- electric screwdriver
- grease pencil or marker
- hex driver
- 180 grit sandpaper or electric sander
- pliers
- razor knife
- soldering iron and solder
- wire cutters
- black electrical tape
- quick-hardening wood putty

Cabinet Modifications

1. Fill in gouges with a good quick-hardening wood putty. Sand cabinet and wipe it clean.
2. Repaint the cabinet with black semi-gloss paint (Games wood grain sides: remove the old decals and clean the glue residue from the old decal before painting). Allow paint to dry completely.
3. Pencil a line roughly at the top of the old graphic. Lightly moisten the cabinet with soapy water. Apply the decal starting at the top and working down. After the decal is in place, smooth it down, taking care to squeeze out the air bubbles. If you miss an air bubble, pop it with a razor blade or a pin and burnish it down. Allow 12 hours for the adhesive in the decals to set. Remove masking.
4. Check the Strike Force Kit for an FCC sticker and apply it over the existing sticker on the cabinet.

When Midway ships a game, it is in compliance with FCC regulations. Your sticker is proof. If the sticker is missing or damaged, legal repercussions to the owner or distributor of the game may result. If your game kit does not contain an FCC sticker, call Midway Manufacturing immediately.

5. Apply the Instructions (Card or Decals) to the CRT viewing glass.

Control Panel Modifications

1. Remove the control panel buttons and joysticks and remove the old vinyl covering.
2. Use the Control Panel Template to help you design your control panel. You will need to use the template twice, once for the left side and once for the right side of the control panel.
3. Drill holes as needed for the joysticks and buttons. Plug previous holes with wood blocks, putty, cardboard or epoxy. File the new holes smooth.
4. Carefully remove the backing on the vinyl control panel overlay. Place the overlay on top of the control panel. Prevent air bubbles from getting under the vinyl overlay.

5. a) After the overlay is on securely, use a razor knife to cut holes for the buttons and joysticks.
 b) Position the stickers around the appropriate button locations. Refer to the Typical Control Panel Layout diagram for suggested button and joystick locations.
6. To mount the pushbuttons and button-holder/switch to the control panel, push the threaded end of the pushbutton through the control panel from the top so that the threads extend through the back of the control panel. Then, take the white plastic button holder/switch and place it over the pushbutton threads so that the threads extend through the hole in the holder. The blade switch must point toward the back of the cabinet and face you. Secure into place with a palnut. Repeat for all of the pushbutton switches.
7. To mount the joystick assembly to the control panel first position the switch assembly so that the square base is against the back of the control panel and the hole in the base lines up with the joystick hole in the control panel. Secure the switch assembly to the control panel. Be sure that one of the blade switches faces the monitor when the control panel is closed. Remove the "E"-ring, white plastic spacer and spring from the joystick shaft. Slip the black plastic washer around the joystick shaft so the rough side faces the handle. Push the shaft through the joystick base from the front of the control panel. After the shaft is through the base, replace the spring, spacer and "E"-ring.

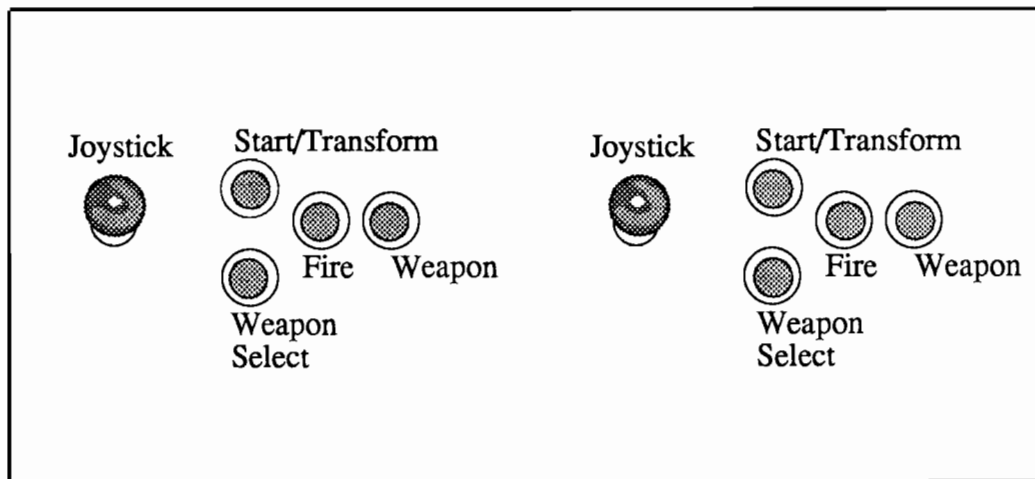

TYPICAL CONTROL PANEL LAYOUT

Note

If you choose to use your own JAMMA Cable and not the one provided in the kit, be sure to check the JAMMA Cable Chart to verify that it is compatible.

Caution

Properly insulate any unused wires within the JAMMA cable, especially the gray, gray-green and gray-yellow wires. This is a fully wired JAMMA cable. Many of the wires will not be used for this kit. These wires have been installed so that you can use this cable for future kits.

Note

The ribbon cable may need to be twisted in order to connect it properly.

Installing the PC Boards and Wiring into a JAMMA Game Cabinet

1. Disconnect and remove the existing CPU board in the JAMMA game cabinet.
2. Mount the Strike Force CPU board inside the JAMMA game cabinet where the old CPU board was located. Mount the sound board next to the CPU board using the stand-offs and screws provided.
3. If you choose to use the JAMMA cable provided with the kit, unsolder your old JAMMA cable from the speaker, power supply, control panel switches (which may already be disconnected) and coin door. Remove the cable from the game. If you are not going to use the JAMMA Cable provided with the kit, check the JAMMA Cable Chart to be sure your cable is compatible. Leave your power supply chassis as is.
4. Connect the JAMMA cable to J1 on the Strike Force CPU board. Using the JAMMA Cable Chart or the Cabinet Wiring Diagram for reference, solder the correct JAMMA cable wires to the speaker, power supply, coin door, control panel switches, and joystick switches. When soldering the joystick switches, be sure to connect the correct wire to the correct blade switch. Follow the Control Panel Wire Color List (pg.3-23), or the Cabinet Wiring Diagram (pg. 3-20).
5. Connect the ribbon cable from J4 on the sound board to J8 on the CPU board. Be sure that the red line goes to the same pin on both boards. Connect the wire harness cable from J5 (speaker), and J3 (power), on the sound board to J2 (sound power speaker connector) on the CPU board.
6. J6, J7, J9, J12 and J14 on the CPU board are not used.
7. Place the FBI Warning Label on the inside of the cabinet next to the PC boards. Be sure the label is completely visible.

Installing the PC Boards and Wiring into a NON-JAMMA Game Cabinet.

1. Disconnect and remove the existing CPU board in the game cabinet.
2. Mount the Strike Force CPU board inside the game cabinet where the old CPU board was removed. Mount the sound board next to the CPU board using the stand-offs and screws provided.
3. Leaving several inches of wire, cut the wires at the coin door, control panel switches (which may already be disconnected) speaker and power supply.
4. Connect JAMMA cable to CPU board at J1. Follow the JAMMA Cable Chart or the Cabinet Wiring Diagram and splice the wires of the JAMMA cable to the existing wires for the coin door, power supply, speaker, control panel switches and joystick switches. When soldering the joystick switches, be sure to connect the correct wire to the correct blade switch. Follow the Control Panel Wire Color List (pg. 3-23), or the Cabinet Wiring Diagram (pg. 3-20). Be sure all of the spliced wires are well insulated with black electrical tape.
5. Connect the ribbon cable from J4 on the sound board to J8 on the CPU board. Be sure that the red line goes to the same pin on both boards. Connect the wire harness cable from J5 (speaker), and J3 (power) on the sound board to J2 (sound power speaker connector) on the CPU board.
6. J6, J7, J9, J12, and J14 on the CPU board are not used.
7. Place the FBI Warning Label on the inside of the cabinet next to the PC boards. Be sure the label is completely visible.

Note

Be sure all spliced wires are well insulated with black electrical tape.

Caution

Properly insulate any unused wires within the JAMMA cable, especially the gray, gray-green and gray-yellow wires. This is a fully wired JAMMA cable. Many of the wires will not be used for this kit. These wires have been installed so that you can use this cable for future kits.

Installing the Volume Control

1. Mount the volume control, using screws provided, where it is easily accessible. On top of the cash box, or on the wall near sound board are two possible locations.
2. The volume control cable attaches the volume control to the sound board at connector J2. When viewed with the white plastic knob facing you, the shield wire should be soldered to the right lug, the red wire should be soldered to the middle lug, and the black wire should be soldered to the left lug.

Volume Control Wiring Diagram

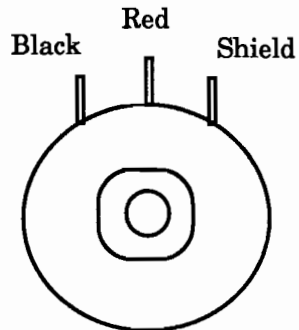

Game Features

Start Up

Switch On power to the game. A "rug" pattern appears on the CRT screen. When the "rug" pattern ends, the screen shows CHECKING SCRATCH RAMS, and then CHECKING ROMS. The next screen shows REVISION LEVEL, CMOS TEST OK and the COIN SETTING. The game then moves to the attract mode. After the proper coinage has been inserted, the game exits the attract mode and enters the play mode.

Player Controls

Each player has an 8-way joystick and four buttons. The joystick controls the movement of the ship. The buttons are Start/Transform, Fire, Weapon and, Weapon Select.

- Each **START/TRANSFORM** button is used to start or continue a game. If a game is in progress, this button toggles the player between ship and turret modes. The ship is more mobile than the turret, but the turret has better firepower. During a 2-player game, if one player is the ship and the other player is the turret, the turret is docked onto the ship unless the player does a quick double-click on the **START/TRANSFORM** button when transforming.
- Each **FIRE** button is used to fire the player's standard weapon. When this button is held down, the weapon goes into rapid-fire mode. The Rapid Fire Counter is incremented by 100 each time a Rapid Fire Icon is picked up. The greater the Rapid Fire Counter value, the faster the weapon fires.
- Each **WEAPON** button is used to fire the special weapons in the player's arsenal. The player is awarded special weapons by starting or continuing a game, by finding them on the planet's surface or, by rescuing colonists. When two players are docked together, they are both awarded a picked up weapon. There are over twelve weapons to discover and master.
- Each **WEAPON SELECT** button is used to select weapons in the player's arsenal. Players accumulate weapons and use them as needed. The weapon currently being used is in a flashing box. Each time the **WEAPON SELECT** button is pressed, the current weapon moves to the end of the arsenal and the rest of the weapons are shifted one to the left. The game announces the name of the chosen weapon so the player knows what is selected without watching the arsenal. It's helpful to keep the sound level loud enough to hear the game's speech clearly.

STRIKE FORCE is a one or two player game that allows two players to play simultaneously.

Note

When an error is detected during Start-up Tests, game start-up does not progress, and an error message appears on the screen.

Game Operation

STRIKE FORCE is a one- or two-player video game with a color monitor. From the player's perspective, the game has two modes of operation: Ready-to-Play and Play. For the owner/operator, the game has an additional mode of operation called Game Diagnostics and Adjustments.

Control Switches

- The **SLAM TILT SWITCH** detects any forceful vibrations against the Coin Door. This eliminates pounding for free games. (optional switch)
- The **VOLUME CONTROL** allows increasing or decreasing the sound level of the game's music and speech. For greater earnings, set your game's sound level at its maximum.
- The **TEST/DIAGNOSTICS SWITCH** allows you to enter the Game's Diagnostics mode. Move the Test Switch left to enter the Game Diagnostics mode. To exit this mode, move the Test/Diagnostic Switch right. (optional switch)
- The **SERVICE CREDIT SWITCH** is a special-feature switch that provides credits during game testing without affecting the game's bookkeeping total. (optional switch)

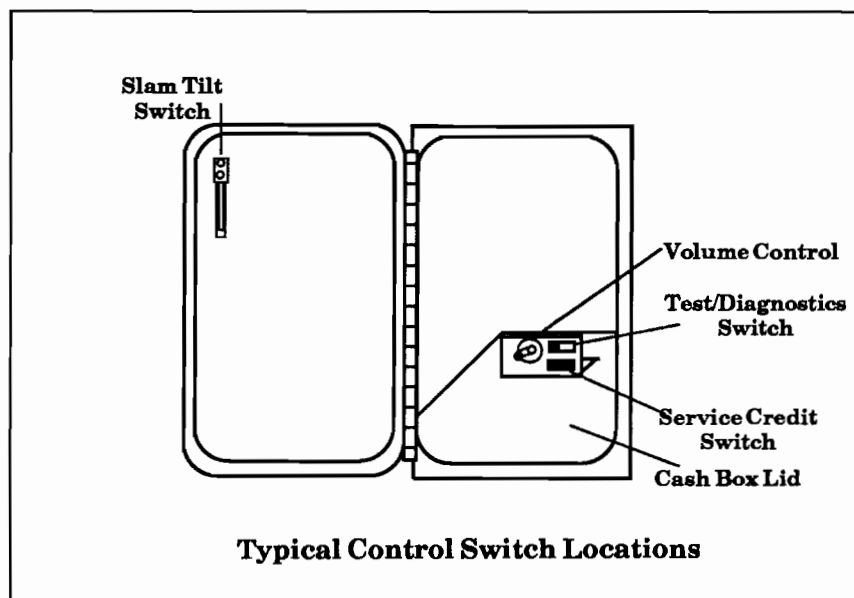

Game Audits, Diagnostics & Adjustments

Operation

All Game Audits and Diagnostics are accessible through the Test/Diagnostic switch if you have installed it, or the DIP switches located on the CPU board, if you have not. Game Adjustments are set or changed using the DIP switches.

GAME AUDITS

To access the Audit Table, move the Test/Diagnostic switch to the left. If you have not installed a Test/Diagnostic switch, then turn On switch #1 on DIP switch #2 To clear the Audits, move both joysticks toward the center of the Control Panel.

Note: Audits cannot be set; they can only be cleared.

To exit the Game Audit Table, move the Test/Diagnostic switch to the right, or turn Off switch #1 on DIP switch #2.

AUDIT TABLE

Audit	Audit Value
Left Chute (# of left chute coins)	0
Right Chute (# of right chute coins)	0
Center Chute (# of center chute coins)	0
Fourth Chute (# of fourth chute coins)	0
Service Credits (# of service credit coins)	0
Credits Played (# of credits played - sum of starts and continues)	0
Player 1 Starts (# of times player 1 started a game)	0
Player 2 Starts (# of times player 2 started a game)	0
Player 1 Continues (# of times played 1 continued a game)	0
Player 2 Continues (# of times player 2 continued a game)	0
One Player Seconds (# of seconds for one player game)	0
Two Player Seconds (# of seconds for two player game)	0
Plays to High Score Reset (# of plays without making H.S. until reset)	0
Average Seconds per Credit (average # of seconds played per coin)	0
Burn-in Loop (# of Burn-in loops completed)	0
Credits (# of unplayed credits available)	0
Idle Minutes (# of idle minutes)	0
Wins (# of games played to completion; starbase destroyed)	0

DIAGNOSTIC TESTS

To access the Tests/Diagnostic Mode, first move the Test/Diagnostic switch to the left, or turn On switch #1 on Dip switch #2. The Audit Table is shown.

To exit the Test/Diagnostic Mode from any test, move the Test/Diagnostic switch to the right, or turn Off switch #1 on DIP switch #2.

CPU Test

To enter the CPU Test from the Audit Table press the Player 2 Weapons Button.

The CPU Test allows the operator to check the game's memory RAM and program ROM chips. The screen shows the layout of the RAMs and ROMs on the CPU board. A good chip turns green. A faulty chip turns red. If no error is found the test cycles back to the Audit Table.

Burn-in Test

To access this test from the Audit Table, press the Player 1 Weapons Button.

The Burn-in Test repeats some of the Diagnostic Tests continually. When the Burn-In Test detects a error, the test stops. Use this test to detect intermittent problems that may not show up during the initial tests.

Note

There are front-mounted monitor controls (beneath the monitor and within the control panel opening) for easier monitor adjustments.

Adjust the black level to just before the black portion turns gray. Adjust the contrast to just before the text starts to blur.

Monitor Test

To access the Monitor Test from the Audit Table, press the Player 1 Start Button.

This test allows the operator to check the monitor operation. There are red, green, and blue screens provided for color adjustments, as well as a crosshatch pattern for alignment adjustments.

During the Monitor Test, the colors should appear sharp and clear. The crosshatch pattern fills the screen with a grid of lines and dots. The pattern should be clear, and the dots should be round.

DIP Switch Test

To access the DIP Switch Test from the Monitor Test, press the Player 1 Start Button.

The DIP Switch Test allows the operator to check the CPU board DIP switch settings.

Switch Test

To access the Switch Test from the DIP Switch Test, press the Player 1 Start Button.

The Switch Test allows the operator to check the switches. Pressing a switch causes the corresponding switch location on the screen to light. Release the switch, and the screen returns to normal.

GAME ADJUSTMENTS

To change the Game Adjustments, use the DIP switches on the CPU.

The Adjustments allow the operator to change the game Pricing and Difficulty levels, among other game features. Use the following DIP switch tables to change the desired adjustment.

DIP Switch 1

	SW 1	SW 2	SW 3	SW 4	SW 5	SW 6	SW 7	SW 8
Difficulty								
Level 1	Off	On	On					
Level 2	Off	Off	On					
Level 3	Off	On	Off					
Level 4*	Off	Off	Off					
Level 5	On	Off	Off					
Level 6	On	Off	On					
Level 7	On	On	Off					
Level 8	On	On	On					
Ships per Credit								
3*				Off				
4				On				
Point per Extra Ship								
40,000					Off	On		
50,000*					Off	Off		
75,000					On	Off		
100,000					On	On		
Start/Continue								
1 credit start, 1 credit continue*							Off	
2 credits start, 1 credit continue							On	
Coin Meters								
Meter 1 sums all switches								Off
Meter 1=switch 1, (3); Meter 2=switch 2, (4)								On
(UK Electronic Door-Meter 1 is #10 Pence units through all switches.)								

Note: * denotes factory setting

DIP Switch 2

	SW 1	SW 2	SW 3	SW 4	SW 5	SW 6	SW 7	SW 8
Game Mode*	Off							
Test Mode	On							
Coin Modes for Chute 1								
1 coin, 1 credit*		Off	Off	Off	Off			
1 coin, 2 credits		Off	Off	Off	On			
1 coin, 3 credits		Off	Off	On	Off			
1 coin, 4 credits		Off	Off	On	On			
1 coin, 5 credits		Off	On	Off	Off			
1 coin, 6 credits		Off	On	Off	On			
2 coins, 1 credit		Off	On	On	Off			
3 coins, 1 credit		Off	On	On	On			
4 coins, 1 credit		On	Off	Off	Off			
5 coins, 1 credit		On	Off	Off	On			
1 coin, 1 credit 2 coins, 3 credits		On	Off	On	Off			
1-2 coins, 1-2 credits 3 coins, 4 credits		On	Off	On	On			
1-3 coins, 1-3 credits 4 coins, 5 credits		On	On	Off	Off			
1-4 coins, 1-4 credits 5 coins, 6 credits		On	On	Off	On			
3 coins, 1 credit 5 coins, 2 credits		On	On	On	Off			
1 coin, 2 credits 2 coins, 5 credits		On	On	On	On			
Coin Modes for Chute 2								
1 coin, 1 credit*						Off	Off	Off
1 coin, 2 credits						Off	Off	On
1 coin, 3 credits						Off	On	Off
1 coin, 4 credits						Off	On	On
1 coin, 5 credits						On	Off	Off
1 coin, 6 credits						On	Off	On
UK Electronic Door chute 1 - 1 pound, 7 credits chute 2 - 50 pence, 3 credits chute 3 - 20 pence, 1 credit chute 4 - 10 pence, 1/2 credit		On	On	On	On	On	On	Off
Free Play		On	On	On	On	On	On	On

Note: * denotes factory setting

Troubleshooting

Problem	Possible Solution
No picture, or distorted picture.	Check for faulty CPU board or monitor. Check for disconnected video signal cable.
Turn game on & nothing happens.	Check line fuse. Check for +5V DC at pins C, D, 3, 4 of the JAMMA Connector.
No sound.	Check the speaker and speaker connection to pins L and 10 on JAMMA Connector. Check volume control setting. Check for +12V DC at pins F and 6 on the JAMMA Connector. Check interboard wiring from CPU board to Sound board.
Move joystick and the objects do not move.	Check for open wires between joystick and CPU board. Check for contamination on joystick switch contacts and CPU board pins. Check for proper ground.
Move joystick and the objects move in the wrong direction.	Check the wiring on the joystick blade switches. Be sure to follow the Control Panel Wire Colors List or, the Cabinet Wiring Diagram when connecting the joysticks.
Press control panel button and nothing happens.	Check for open wires between button and the CPU board. Check for contamination on the CPU board pins or button switch blade contacts. Check for proper ground.
No credit given when coins are inserted.	Check DIP switch coin setting. Check for contamination on coin switch contacts. Check for an open wire between Coin Switch 1 and pin 16 on JAMMA Connector or Coin Switch 2 and pin T of JAMMA Connector.
Too many credits for the number of coins inserted.	Check price setting. Check for a short between pins T & 16 on JAMMA Connector.
The game stays in the test mode.	Check that the Test/Diagnostic switch and switch #1 on DIP switch #2 are Off.

NOTES

S E C T I O N
two

PC Board Parts Information

A-13234-43313 Y-UNIT CPU BOARD ASSEMBLY

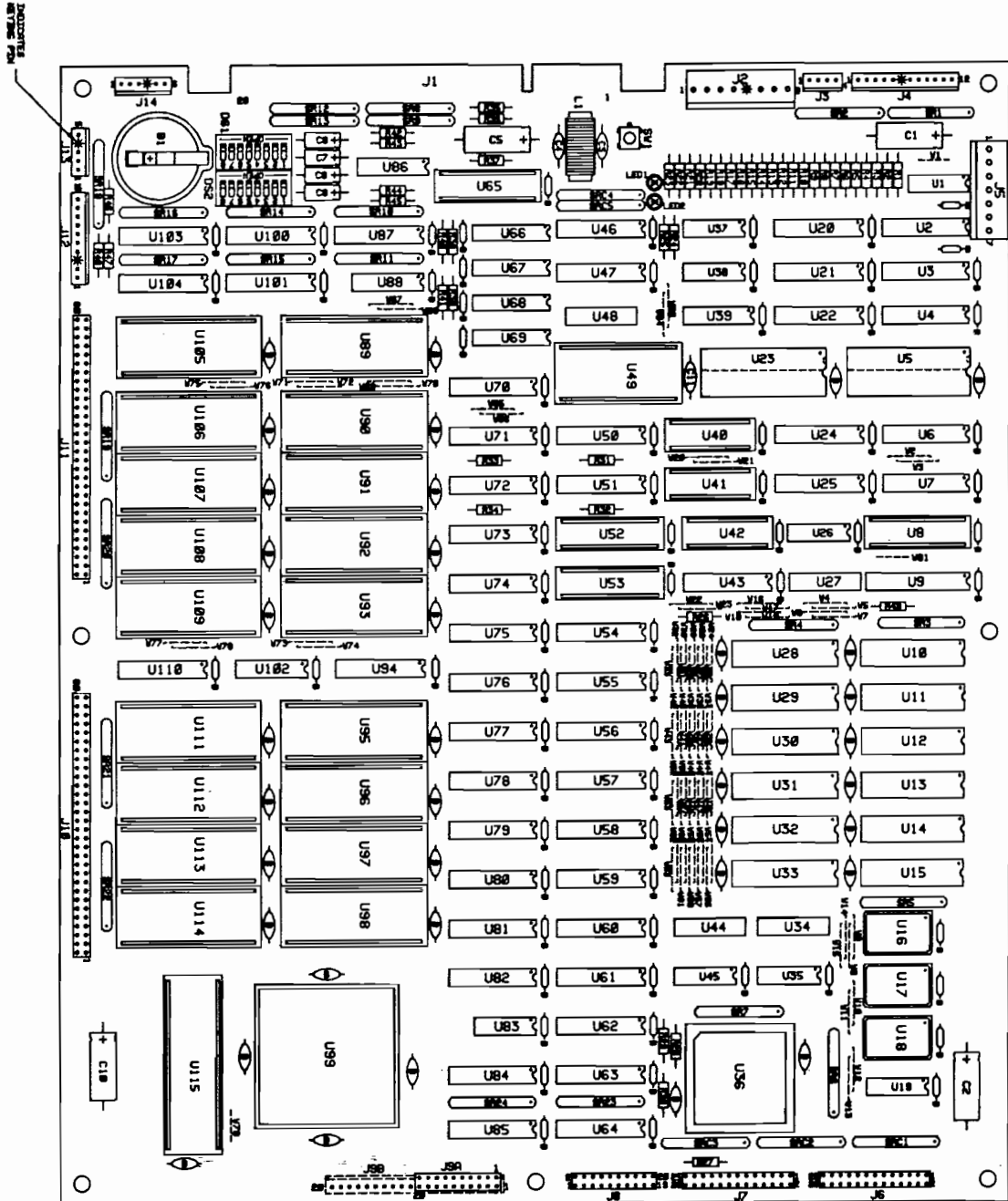

A-13234-43313

Y-UNIT CPU BOARD ASSEMBLY

Part No.	Ckt.Designator	Description	Part No.	Ckt.Designator	Description
5770-12555-00		Bare PC Brd.	5043-08980-00	B	Cap. .01 μfd 10V
5281-09737-00	U1	IC, 74LS 86	5040-08986-00	C1, C2, C5, C10	Cap. 100μfd 10V
5317-12211-00	U2, U20, U24, U43		5043-09845-00	C3, C4	Cap. .001μfd 10V
	U61, U62, U70	IC, 74ALS541	5041-09243-00	C6-C9	Cap. 10μfd 10V
5317-12212-00	U3, U6, U7, U21, U25	74ALS574	5043-8996-00	C11	Cap. .1μfd
	U50, U58, U63, U64		5019-12611-00	SR1, SR2, SR8	SIP, 470Ω 5 Res.
	U71, U72, U74, U79, U84, U85			SR9, SR12, SR13	
5317-12208-00	U4, U22, U54-U57	74ALS245		SR18	
	U59, U60, U75-U78		5019-09362-00	SR3, SR4, SR6	SIP, 4.7KΩ
	U80, U81, U94, U110			SR7, SR11, SR15	
5340-12242-00	U5, U23	IC, 8K x 8 S RAM		SR17, SR19-SR24	
5700-12047-00	U8, U52, U53, U65	24 pin Socket		SRC1-SRC3	
5340-12213-00	U10, U11, U28-U33	IC, 4461 VRAM	5019-10143-00	SR5	SIP, 470Ω 9 Res.
5521-10421-00	U16	48 MHZ Xtal	5060-10396-00	SRC4, SRC5	SIP. 4.7KΩ 470pf
5521-10318-00	U17	24 MHZ Xtal		SRC10, SRC14	
5283-10468-00	U19, U45	IC, 74F74		SRC16	
5019-10849-00	U27, U34, U44, U48	100Ω DIP Res.	5671-09019-00	LED1, LED 2	LED, Red
5317-12305-00	U35	IC, 74ALS00	5551-09822-00	L1	Inductor, 4.7UH
5700-12253-00	U36	68 pin Socket	5645-09025-00	DS1, DS2	DIP. Sw. 16 pin
5280-09309-00	U37	IC, 7407	5641-12551-00	SW1	Pushbutton Sw.
5281-09487-00	U38	IC, 74LS74	5881-12315-00	B1	Battery Holder
5434-12255-00	U39	IC, MAX691	5791-10862-08	J2	8 pin Connector
5700-09915-00	U40-U42	20 pin Socket	5791-12461-12	J4	12 pin Connector
5311-12287-00	U47, U46, U87, U100	IC, 74HC541	5791-10850-00	J6, J7	26 pin Ribbon Connector
	U101, U103, U104			J8	20 pin Ribbon Connector
5700-10176-00	U49	28 pin Socket	5791-09437-00	J8	20 pin Ribbon Connector
5311-12285-00	U51, U73, U82	IC, 74HC573		J12	10 pin Connector
5340-12014-00	U66-U69	IC, 4464 DRAM	5791-12461-10	U12-U15	24 pin Socket
5283-10552-00	U83	IC, 74F04	5700-12252-00		50 pin Connector
5370-12602-00	U86	IC, ULN2064B	5719-12461-05	J13	CPU Sub-assembly
5317-12023-00	U88	IC, 74ALS138	C-13235-2		IC, PLD Color RAM
5700-12088-00	U89-U93, U95-U98	32 pin Socket	A-5346-43313-1	U8	IC, TMS34010-50
	U105-U109, U111-U114		5400-12220-00	U36	IC, PLD Address Decoder
5700-12254-00	U99	144 pin Socket	A-5346-43313-2	U40	IC, PLD Video RAM
5317-12024-00	U102	IC, 74ALS139	A-5346-43313-3	U41	IC, PLD Local Control
5700-08985-00	U115	40 pin Socket	A-5346-43313-10	U42	IC, PLD Local Control
5010-08991-00	R1, R24, R27	Res. 4.7KΩ 5% 1/4W	5340-12558-00	U49	IC 8Kx8 Static RAM 100ns
5010-10204-00	R2, R7, R12	Res. 1KΩ 2% 1/4W	A-5346-43313-11	U52	IC, PLD Video RAM Sequ.
5010-10205-00	R3, R8, R13	Res. 2KΩ 2% 1/4W	A-5346-43313-6	U53	IC, PLD Image ROM
5010-10000-00	R4, R9, R14	Res. 3.9KΩ 5% 1/4W	A-5346-43313-7	U65	IC, PLD Miscellaneous
5010-09219-00	R5, R10, R15	Res. 8.2KΩ 5% 1/4W	A-5346-43313-8	U115	IC, PLD Autoerase
5010-08772-00	R6, R11, R16	Res. 15KΩ 5% 1/4W			
5010-09001-00	R23, R25	Res. 330Ω 5% 1/4W			
5010-09036-00	R26, R29-R34	Res. 100Ω 5% 1/4W			
5010-09416-00	R35-R37, R46-R48	Res. 470Ω 5% 1/4W	A-5343-43313-1	U89	IC, Game EPROM
5010-08997-00	R38-R45	Res. 2.7Ω 5% 1/4W	A-5343-43313-2	U90	IC, Game EPROM
5010-09534-00	W2, W8, W11, W12,	Res. 0Ω	A-5343-43313-3	U91	IC, Game EPROM
	W14, W21, W22, W24,		A-5343-43313-6	U95	IC, Game EPROM
	W27, W28, W31, W32,		A-5343-43313-7	U96	IC, Game EPROM
	W35, W37, W39, W41,		A-5343-43313-8	U97	IC, Game EPROM
	W43, W44, W46, W48,		A-5343-43313-9	U98	IC, Game EPROM
	W50, W52, W54, W56,		5410-12239-00	U99	IC, Custom ASIC
	W58, W60, W62, W66,		A-5343-43313-10	U105	IC, Game EPROM
	W68, W69, W72, W74,		A-5343-43313-11	U106	IC, Game EPROM
	W76, W78, W80		A-5343-43313-12	U107	IC, Game EPROM
			A-5343-43313-15	U111	IC, Game EPROM
			A-5343-43313-16	U112	IC, Game EPROM
			A-5343-43313-17	U113	IC, Game EPROM
			A-5343-43313-18	U114	IC, Game EPROM
			5880-11056-00	B1	Battery, Lithium 3V

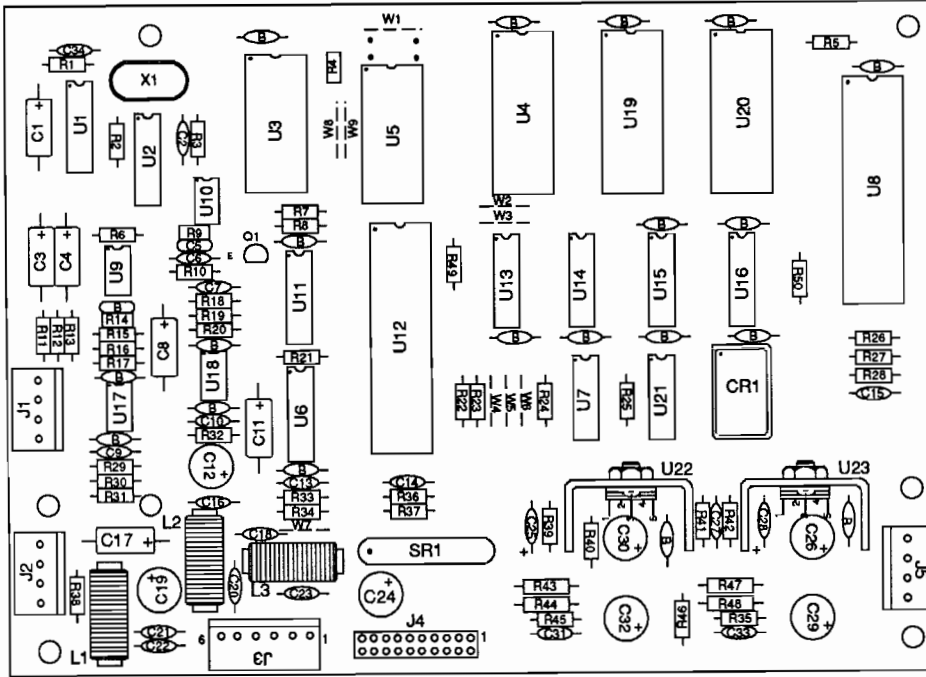

A-13971-43313 Sound Board Assembly

Part No.	Ckt Designator	Description	Part No.	Ckt Designator	Description
5766-12130-00		Bare P. C. Board	5010-10985-00	R14, R15	Resistor, 20K, 1/4w, 5%
5371-11087-00	U1	IC, D/A Conv, YM3012	5010-09034-00	R22-R24, R17, R34	Resistor, 10K, 1/4w, 5%
a) 5700-09006-00		Socket, IC, 16-pin (U1)	5010-09324-00	R6, R19, R20, R21	Resistor, 27K, 1/4w, 5%
5370-11086-00	U3	IC, Sound Processor, YM2151	5010-09162-00	R39	Resistor, 100K, 1/4w, 5%
a) 5700-09004-00		Socket, IC, 24-pin (U3)	5010-09331-00	R16	Resistor, 13K, 1/4W, 5%
5400-10320-00	U8	IC, μ Processor, MC68B09E	5013-09427-00	R13	Resistor, 4.99K Ω , 1/4W, 1%
a) 5700-08985-00		Socket, IC, 40-pin (U8)	5010-08772-00	R18	Resistor, 15K Ω , 1/4W, 5%
A-5343-43313-19	U4	IC, Audio ROM 1	5010-08824-00	R32	Resistor, 43K Ω , 1/4W, 5%
A-5343-43313-20	U19	IC, Audio ROM 2	5010-08846-00	R31	Resistor, 220K Ω , 1/4W, 5%
A-5343-43313-21	U20	IC, Audio ROM 3	5010-09219-00	R38	Resistor, 8.2K, 1/4W, 5%
a) 5700-10176-00		Socket, IC, 28-pin (U4, U19)	5010-10258-00	R40	Resistor, 1M, 1/4w, 5%
A-13970-1		Sub-assembly PCB	5010-09179-00	R10	Resistor, 3.3M, 1/4w, 5%
5370-09691-00	U6	IC, 55536, CVSD	5010-09333-00	R29	Resistor, 180K Ω , 1/4W, 5%
5371-09152-00	U11	IC, D/A Convtr, MC1408	5010-09342-00	R30	Resistor, 36K Ω , 1/4W, 5%
5430-10322-00	U12	IC, PIA, MC68B21	5010-09534-00	W2, W9, W11	Resistor, 0 Ω , 1/4w, 5%
5340-10139-00	U5	IC, RAM/S 5516-2 2Kx8	5046-09350-00	C9	Capacitor, 180pfd, 100V, \pm 5%
5281-09487-00	U16, U7	IC, Dual D Flipflop, 74LS74	5048-10992-00	C10	Capacitor, 4700pfd, 50V, \pm 10%
5281-10043-00	U13	IC, 74LS175	5046-09346-00	C7	Capacitor, 1200pfd, 50V, \pm 5%
5281-09235-00	U21	IC, Triple NAND, 74LS10	5040-09365-00	C11	Capacitor, 1 μ fd, 63V, \pm 10%
5370-09321-00	U9, U10, U17, U18	IC, Op Amp, MC1458	5040-09343-00	C1, C3, C4, C8, C17	Capacitor, 10 μ fd, 20v, \pm 20%
5281-09215-00	U2	IC, Hex Inv, 74LS04	5040-10974-00	C12, C19, C24	Capacitor, 100 μ fd, 35v
5281-09246-00	U14	IC, 2-4 Dec, 74LS139	5040-09776-00	C26, C30	Capacitor, 470 μ fd, 16v; +50, -10%
5281-09745-00	U15	IC, Dual Mux, 74LS138	5040-12006-00	C29, C32	Capacitor, 1000 μ fd, 16v, 20%
5370-09156-00	U22, U23	IC, Audio Amp, TDA2002	5041-09243-00	C25, C28	Capacitor, 10 μ fd, 10v, \pm 10%
a) 5705-09199-00		Heatsink, #6030B	5043-08980-00	C5, B (21)*	Capacitor, 0.01 μ fd, 50v, +80, -20%
b) 4006-01003-06		Mach. Screw, 6-32 x 3/8	5043-08996-00	C31, C33	Capacitor, 0.1 μ fd, 50v, \pm 20%
c) 4406-01117-00		Nut, 6-32 Hex.	5043-09065-00	C13 - C15	Capacitor, 470 pfd, 50v, \pm 20%
d) 4703-00007-00		Lockwasher, #6 Ext.	5043-09492-00	C2, C34	Capacitor, 100 pfd, 50v, \pm 10%
5160-10269-00	Q1	Transistor, 2N3904, NPN	5043-09844-00	C6	Capacitor, 47 pfd, 50v, \pm 20%
5060-10396-00	SP1	SIP 4.7K & 470pfd, 8R8C	5043-09845-00	C16, C18, C20 -	Capacitor, 1000 pfd, 50v, \pm 20%
5010-09181-00	R44, R48	Resistor, 1.0 Ω , 1/2w, 5%		C23, C27	
5010-09161-00	R35, R45	Resistor, 2.2 Ω , 1/4w, 5%	5520-09020-00	X1	Crystal, 3.58 MHz
5010-09361-00	R43, R46, R47	Resistor, 220 Ω , 1/2w, 5%	5521-10931-00	CR1	Oscillator, 8 MHz
5010-09358-00	R41, R42	Resistor, 1K, 1/4w, 5%	5551-09822-00	L1 - L3	Inductor, 4.7 μ H, 3A
5010-08998-00	R2, R3,	Resistor, 2.2K, 1/4w, 5%	5791-09437-00	J4	Connector, 20 pin, (Hdr), Rib. Cbl
5010-08983-00	R7-R9	Resistor, 3.3K, 1/4w, 5%	5791-10862-04	J1, J2, J5	Connector, 4 pin (Hdr)
5010-08991-00	R1, R4, R5, R11,	Resistor, 4.7K, 1/4w, 5%	5791-10862-06	J3	Connector, 6 pin (Hdr)
	R12, R25 - R28, R33,		16-8850-310		P.C.B. I.D. Label
	R36, R37, R49, R50		20-9229		Thermal Compound
			5010-09086-00	R	Resistor, 6.8K, 1/4W, 5%

NOTES:

- * 21 capacitors (shown on diagram with "B" symbol) provide +5VDC filtering for ICs.
- All capacitors are ceramic, 50v, axial, unless otherwise noted.
- All resistors are 5%, 1/4w, Carbon Film, unless otherwise note.

S E C T I O N
three

Diagrams & Schematics

Sound Board

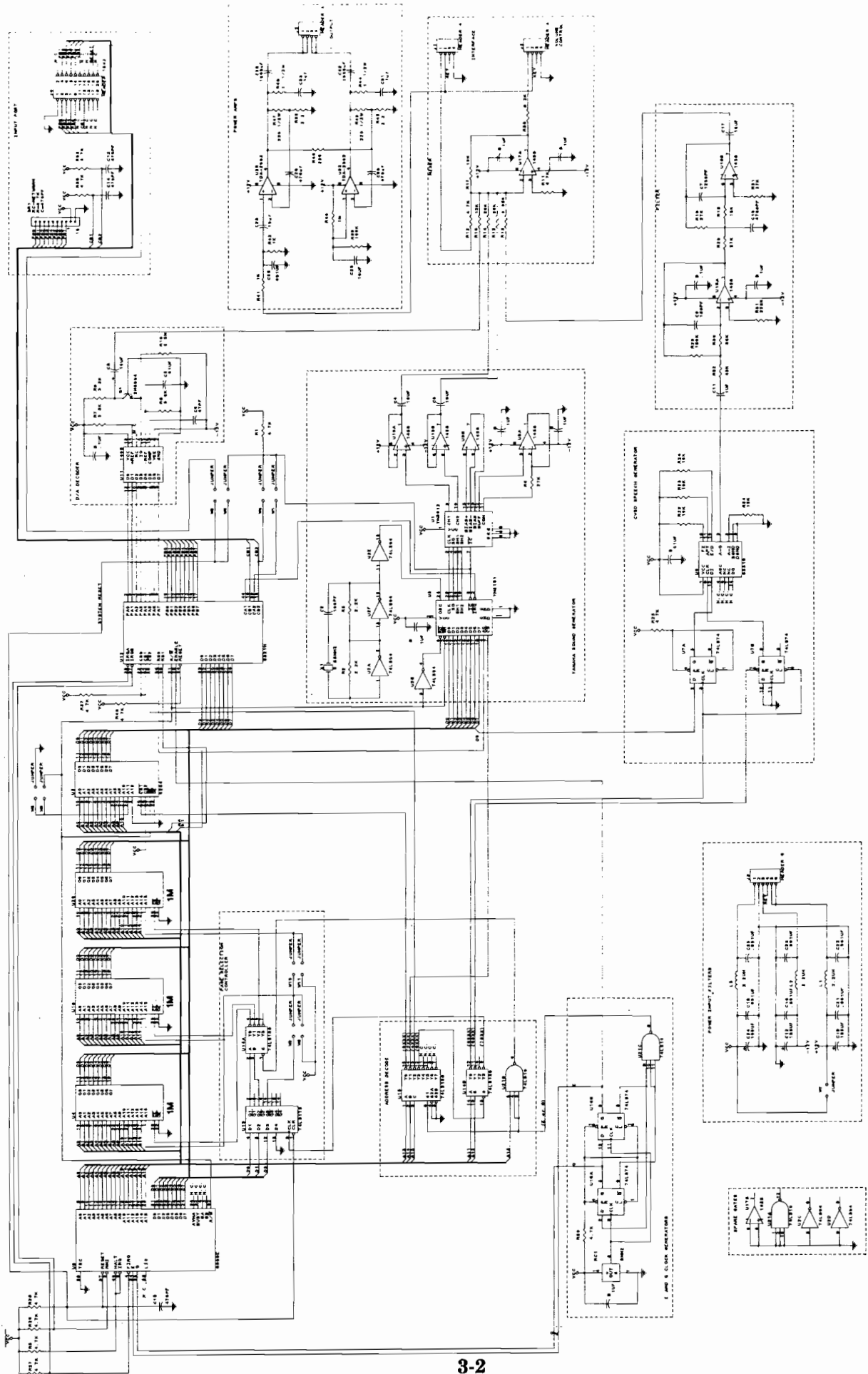

CPU Board sheet 1 of 16

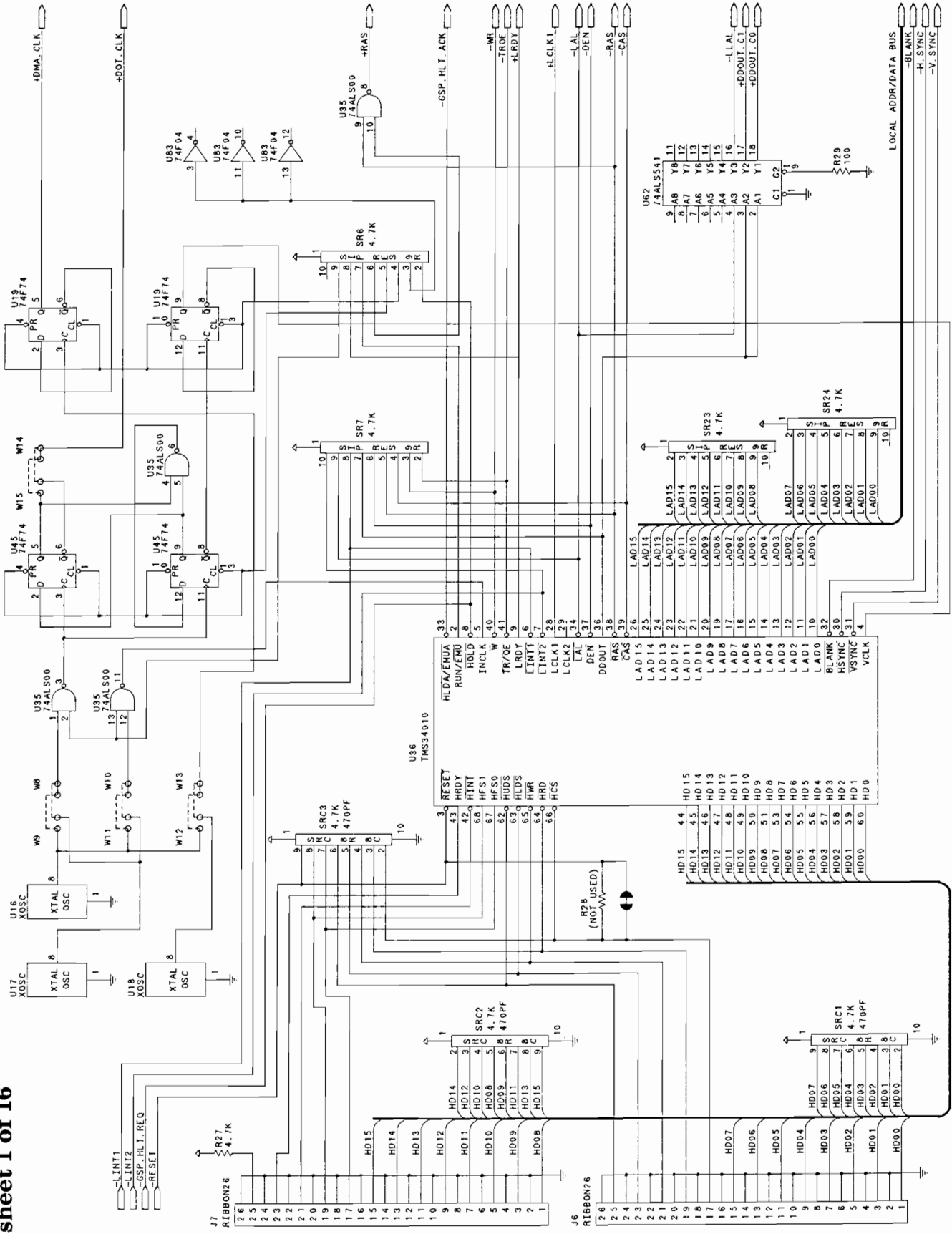

CPU Board sheet 2 of 16

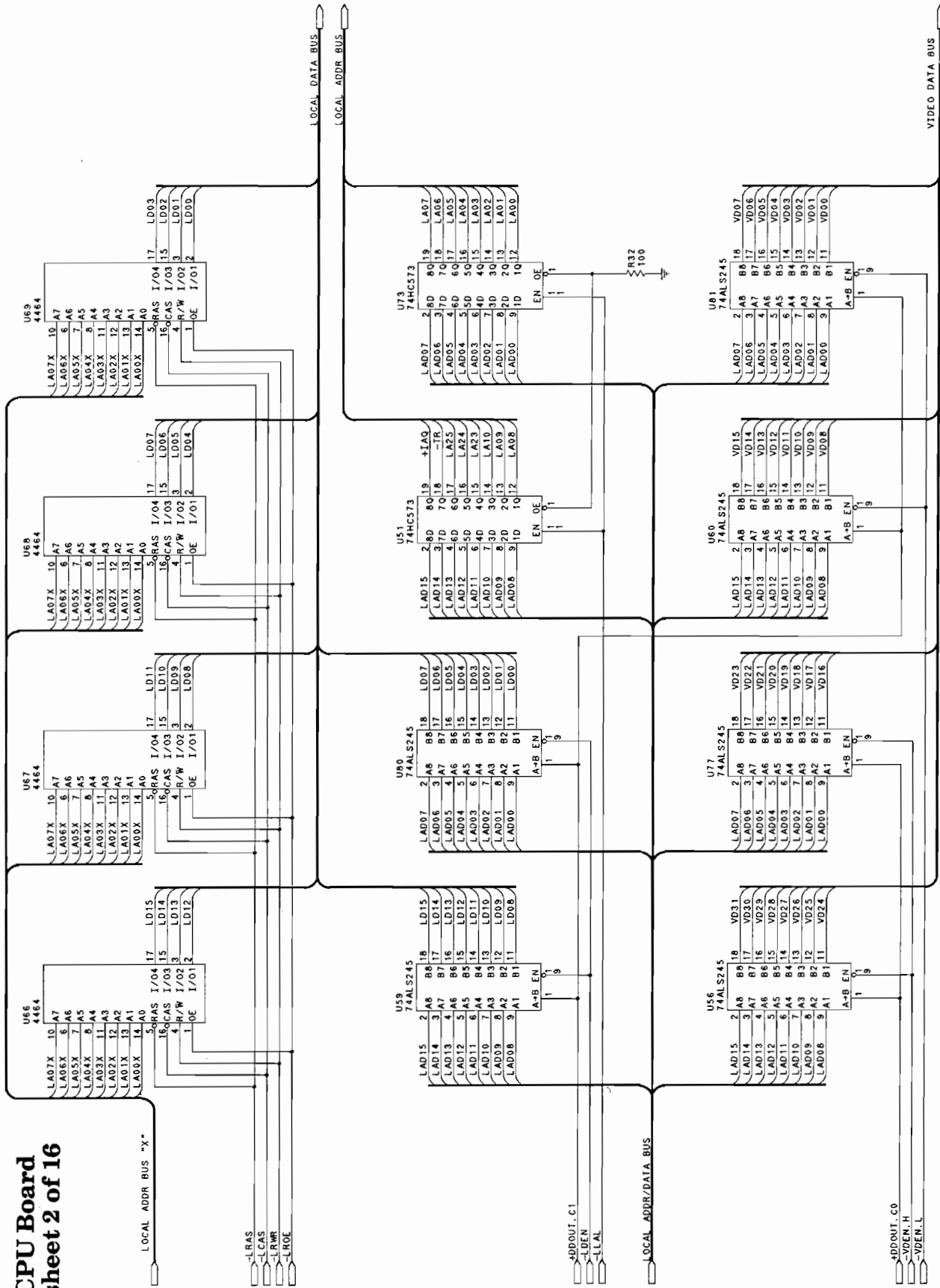

CPU Board sheet 4 of 16

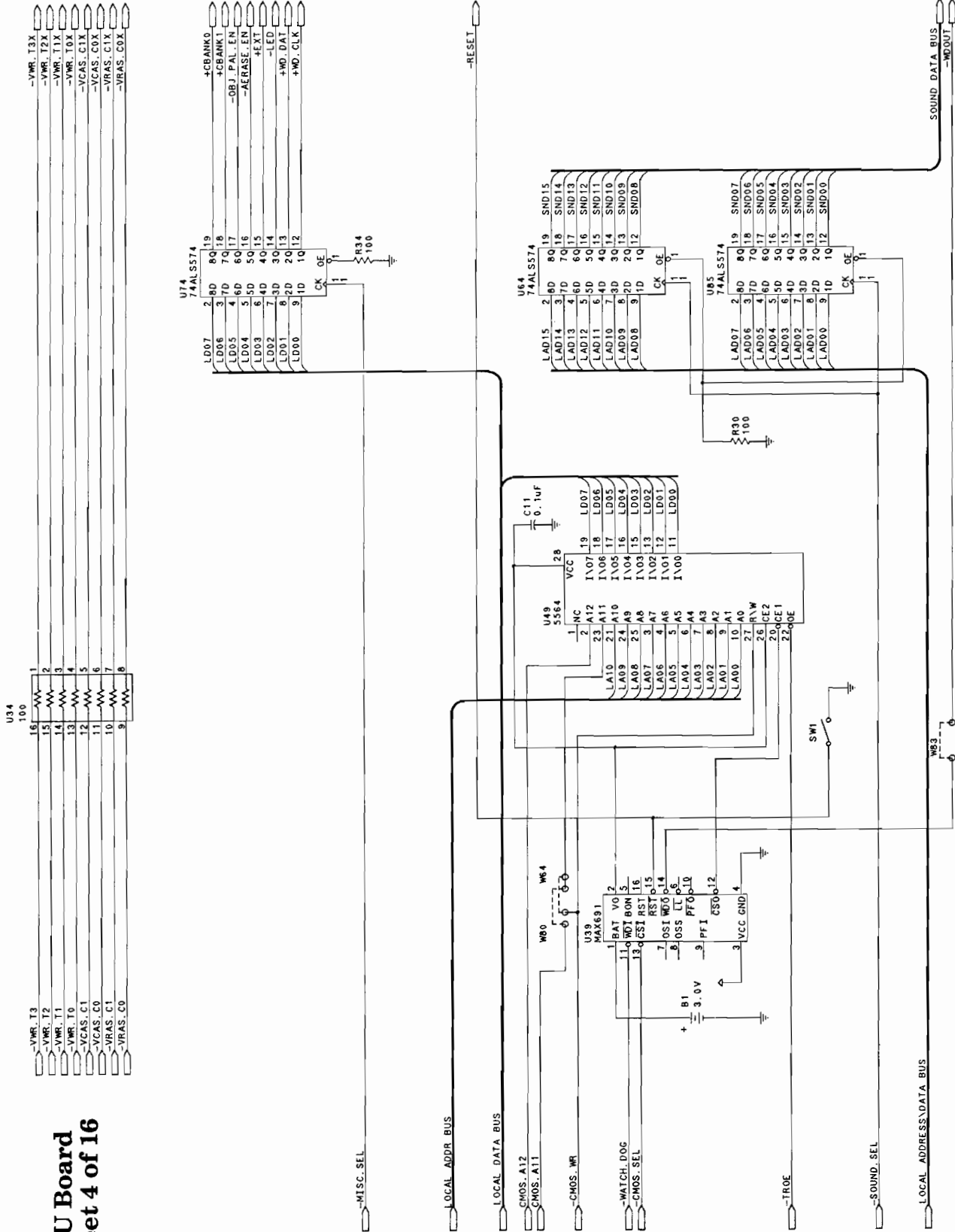

CPU Board sheet 5 of 16

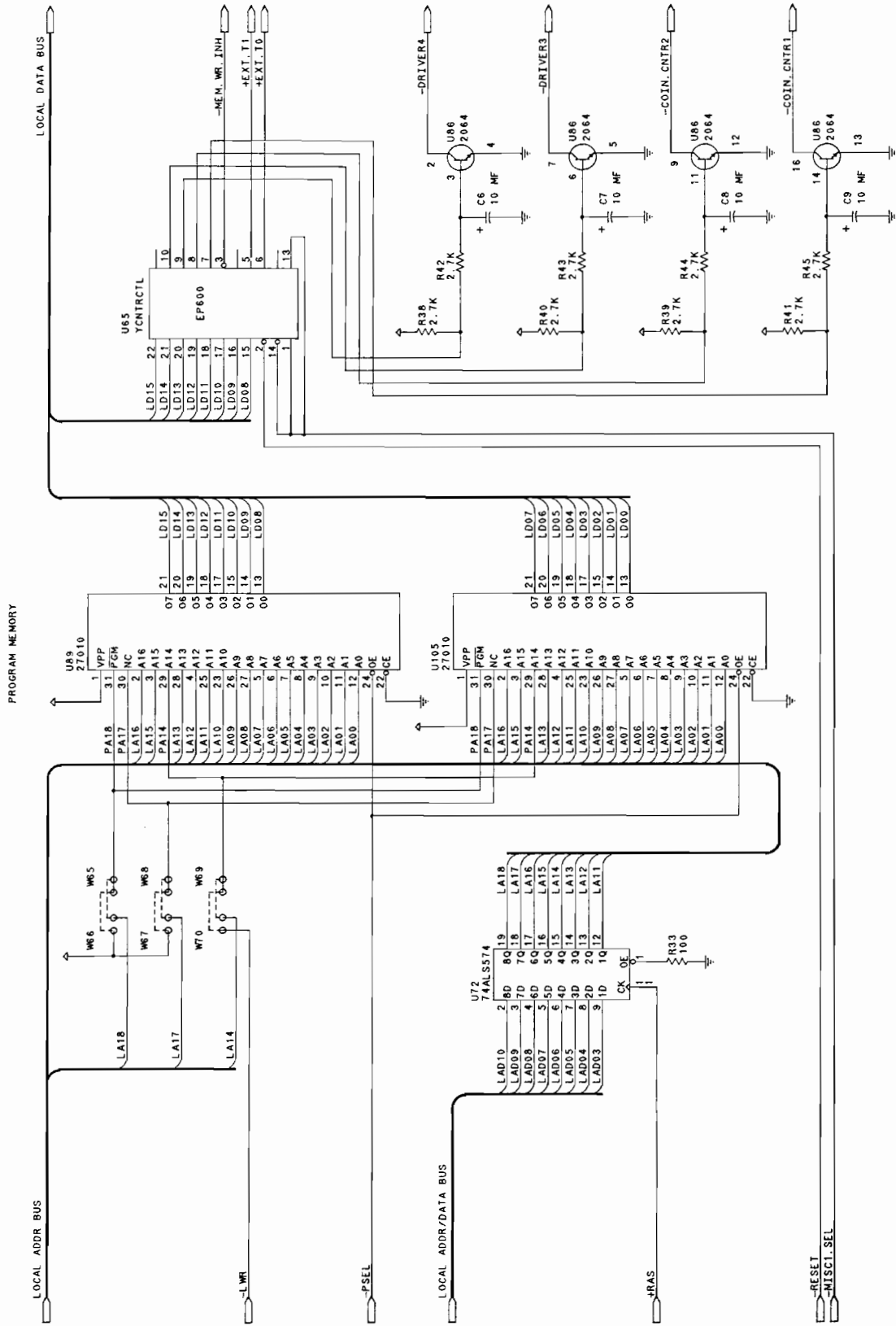

CPU Board sheet 6 of 16

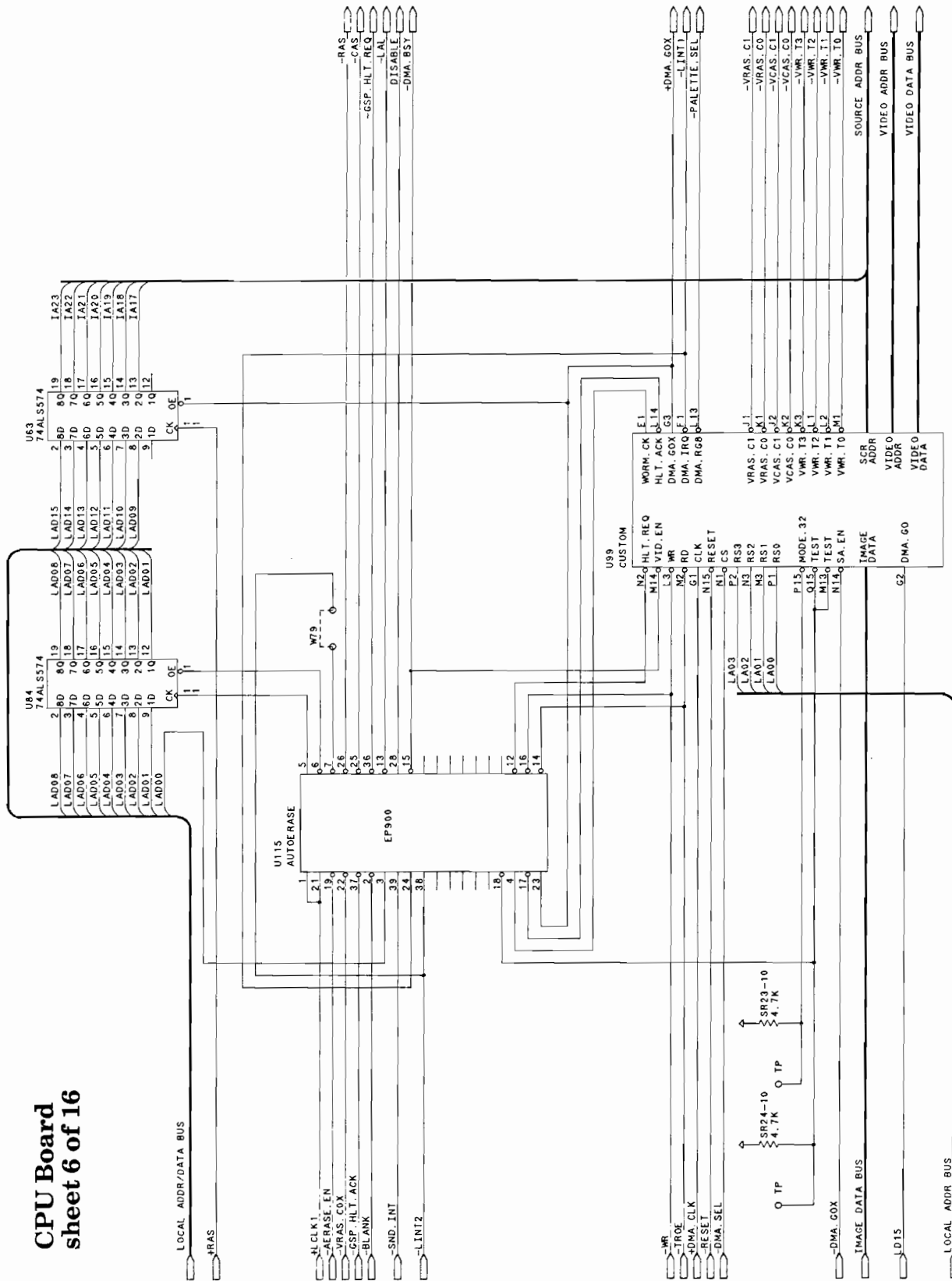

CPU Board sheet 8 of 16

IMAGE MEMORY

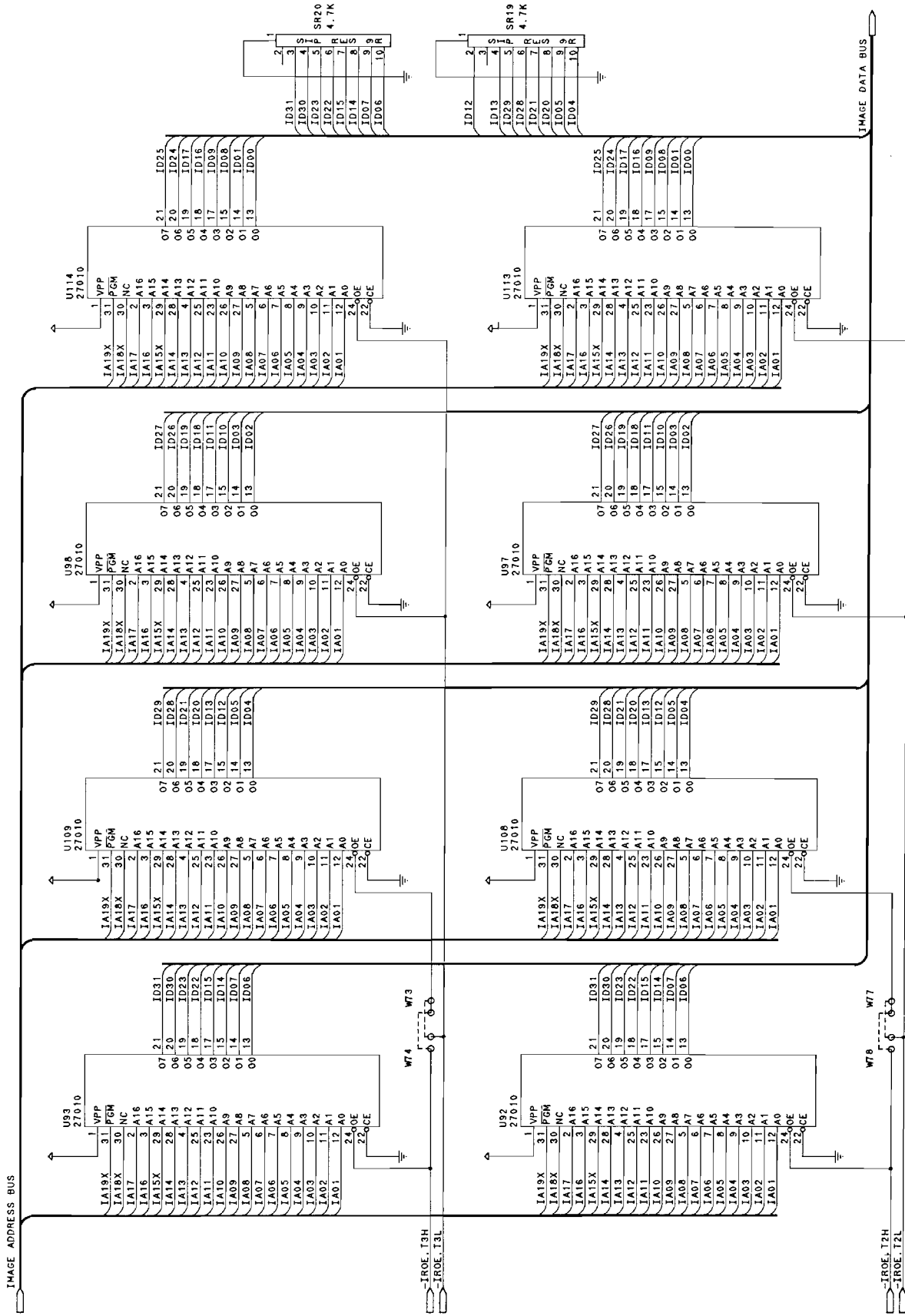

CPU Board sheet 9 of 16

IMAGE MEMORY

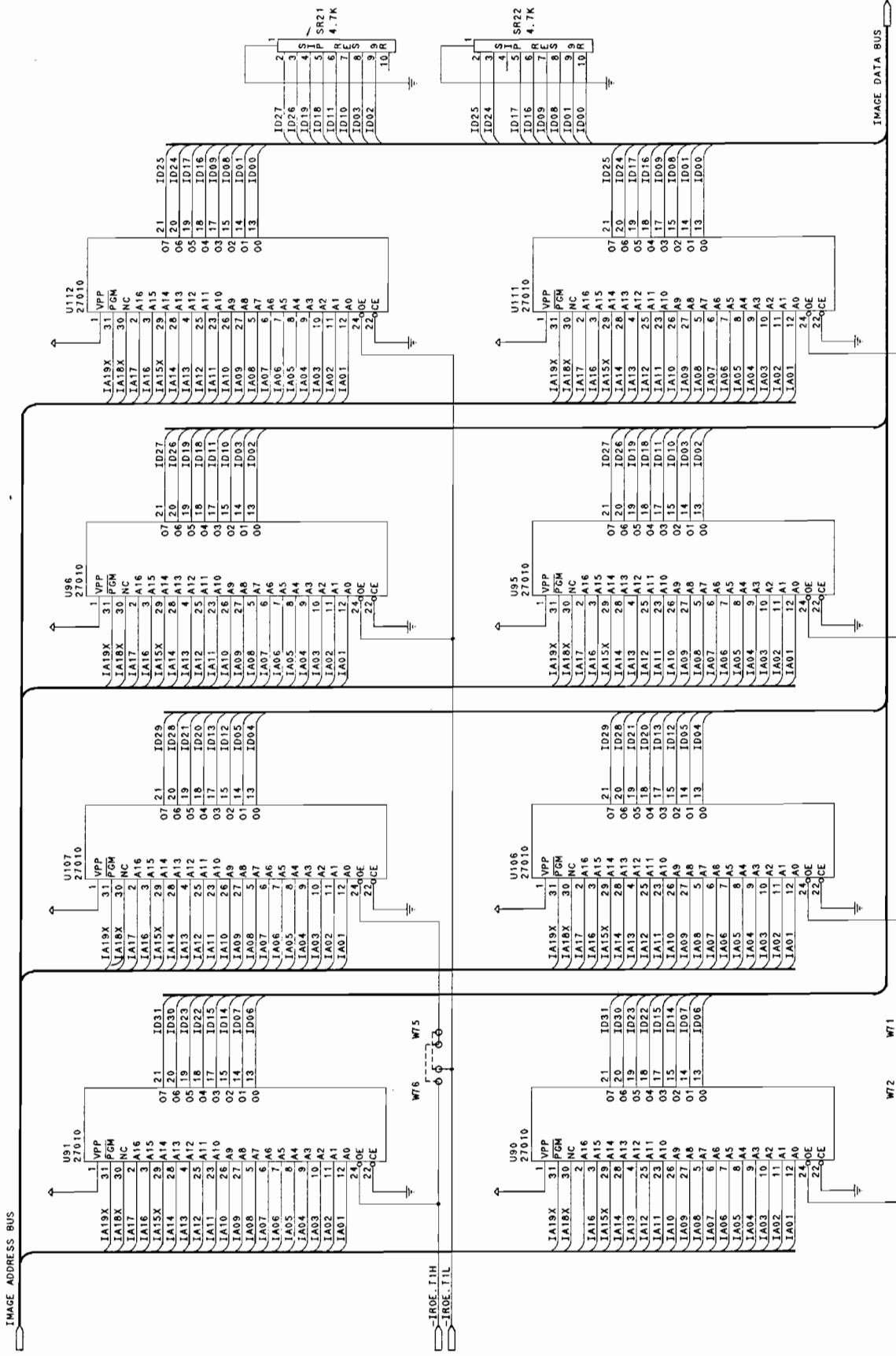

CPU Board sheet 10 of 16

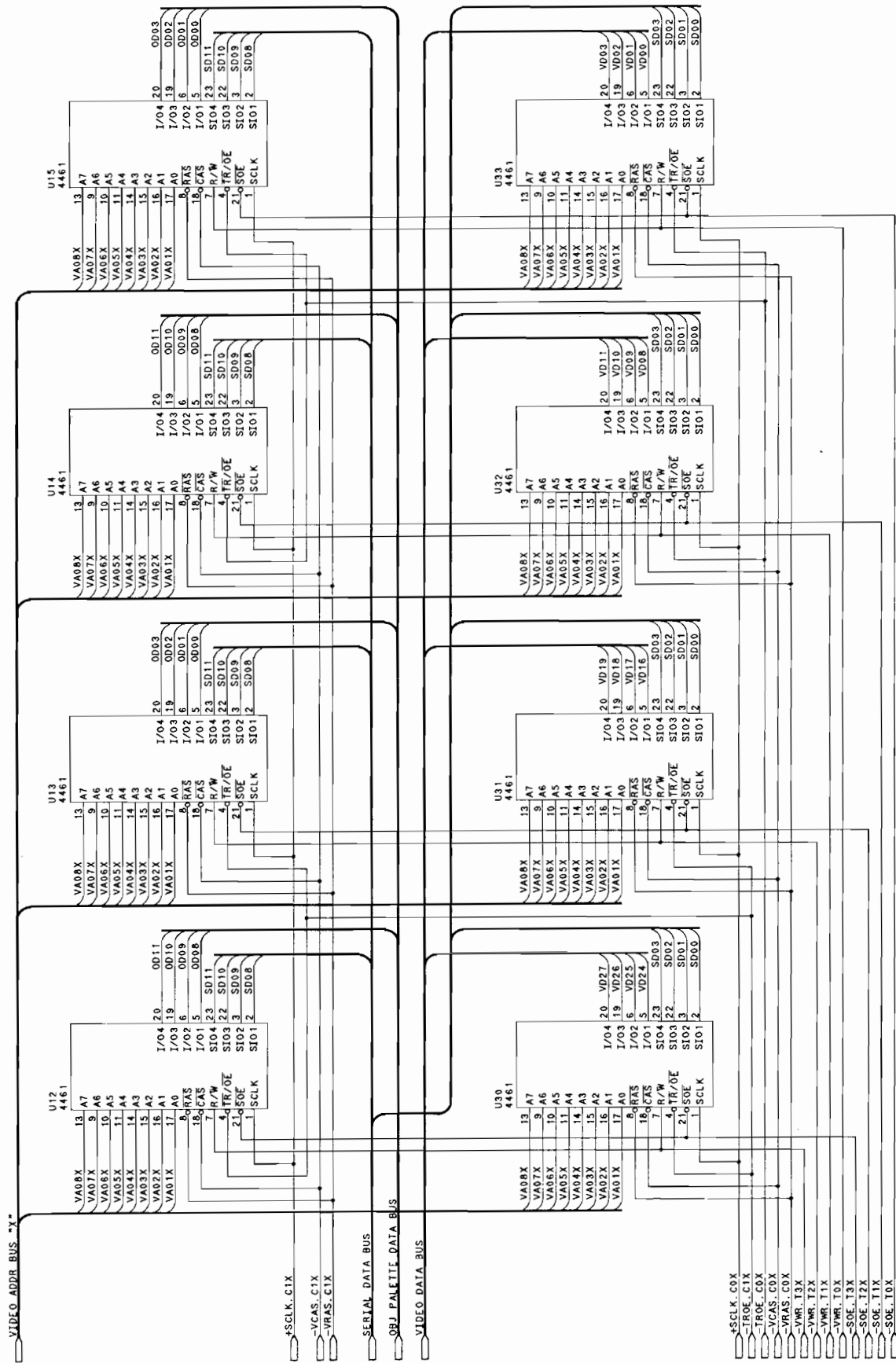

CPU Board sheet 11 of 16

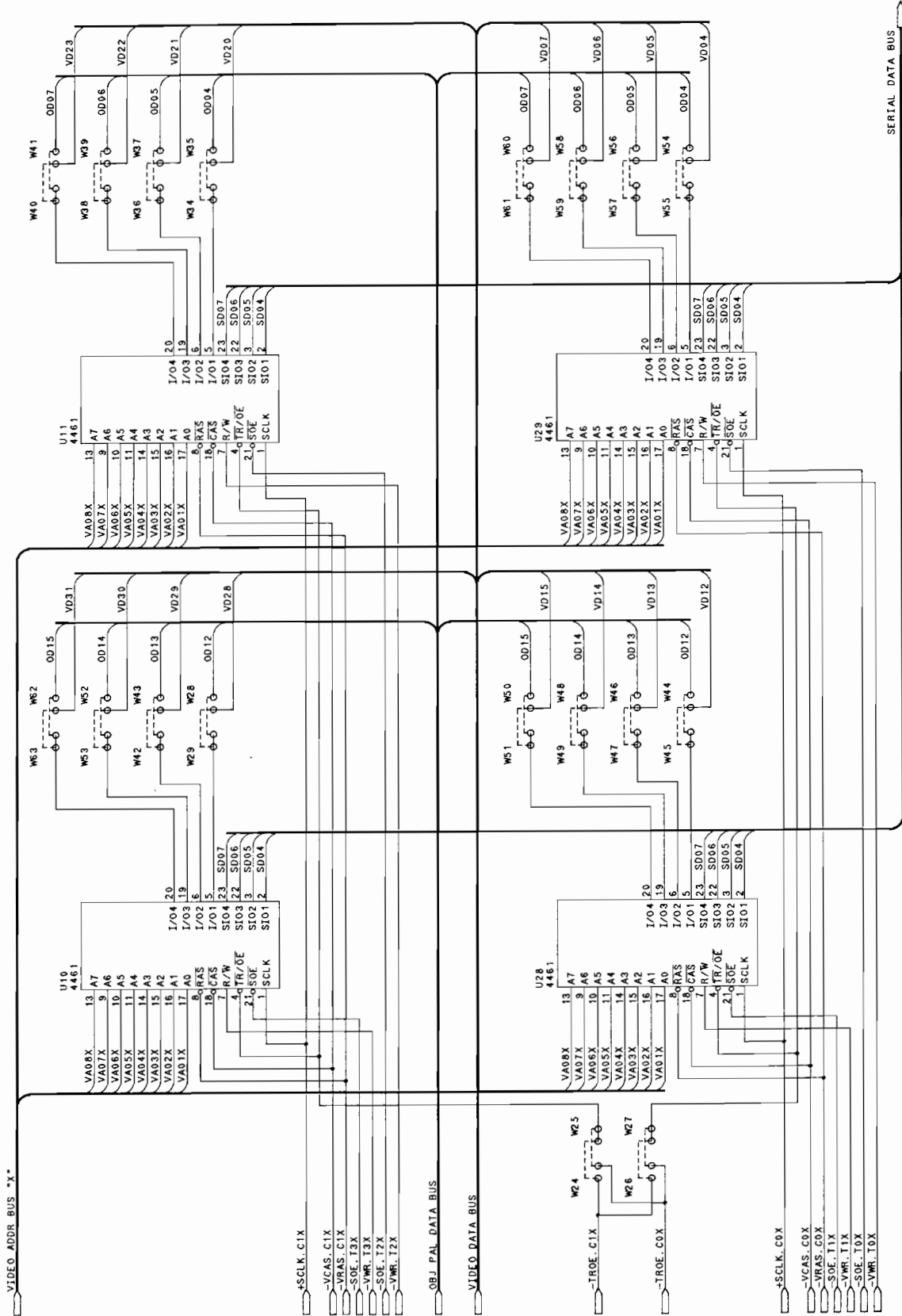

CPU Board sheet 12 of 16

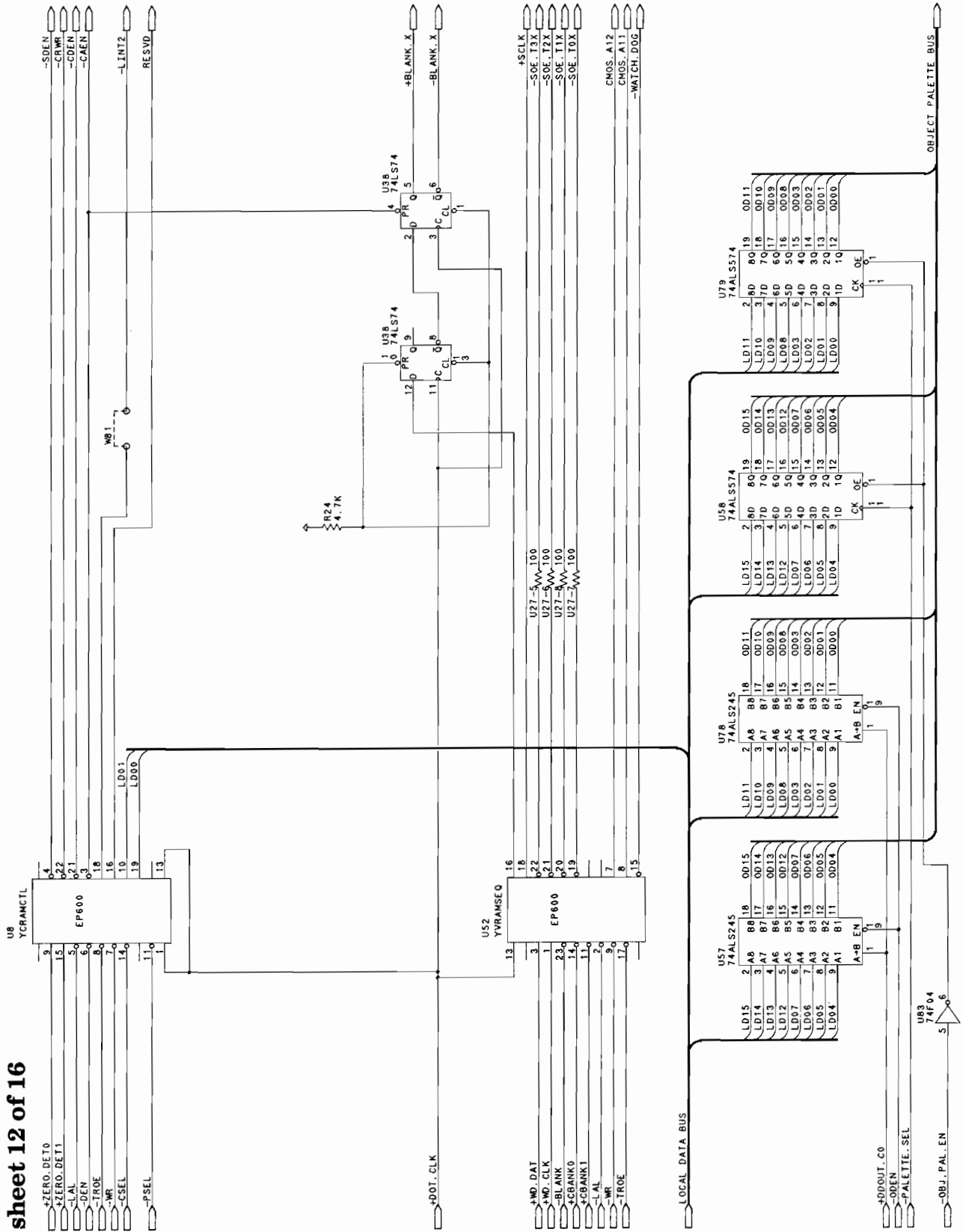

CPU Board sheet 14 of 16

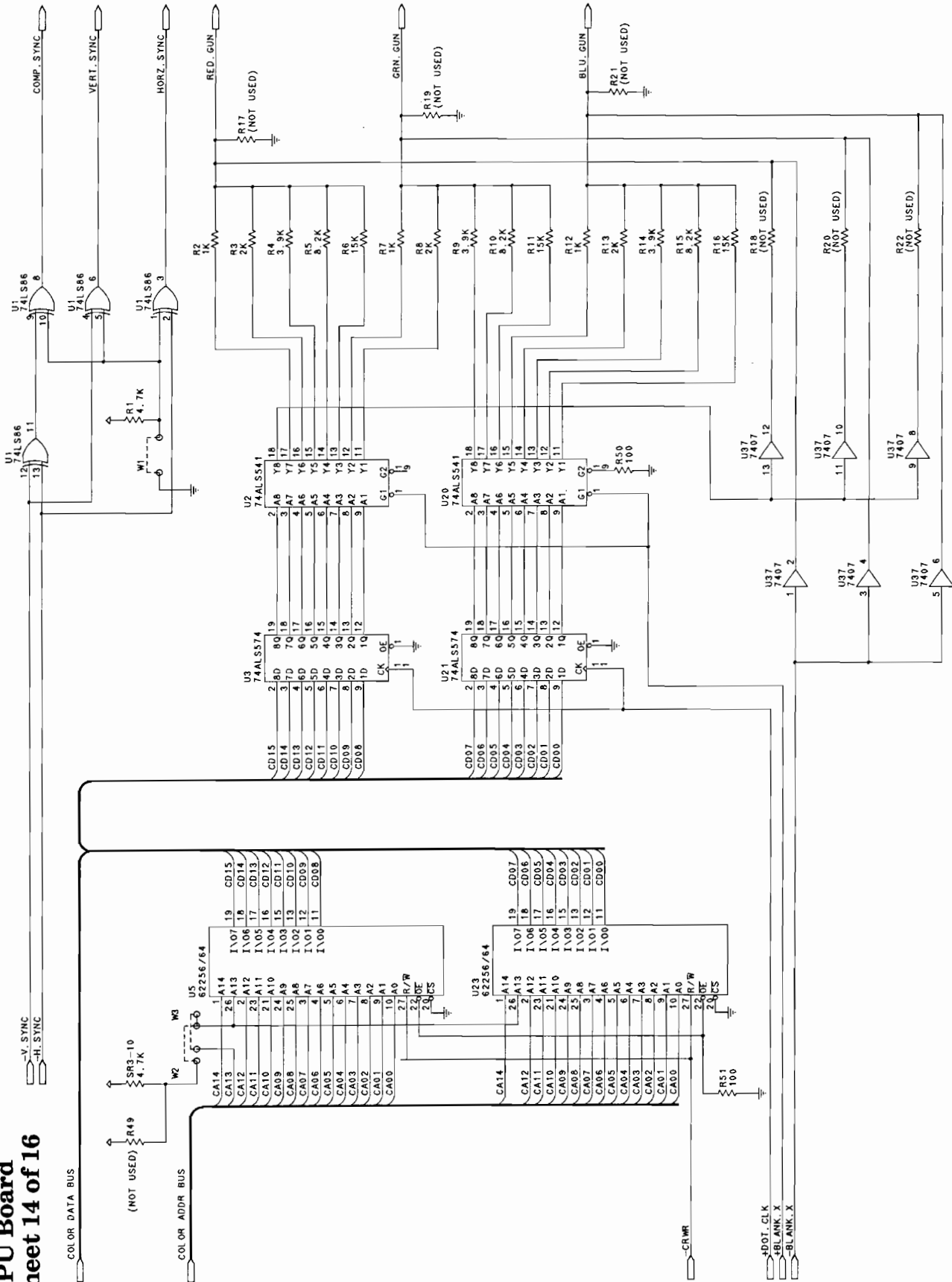

CPU Board sheet 15 of 16

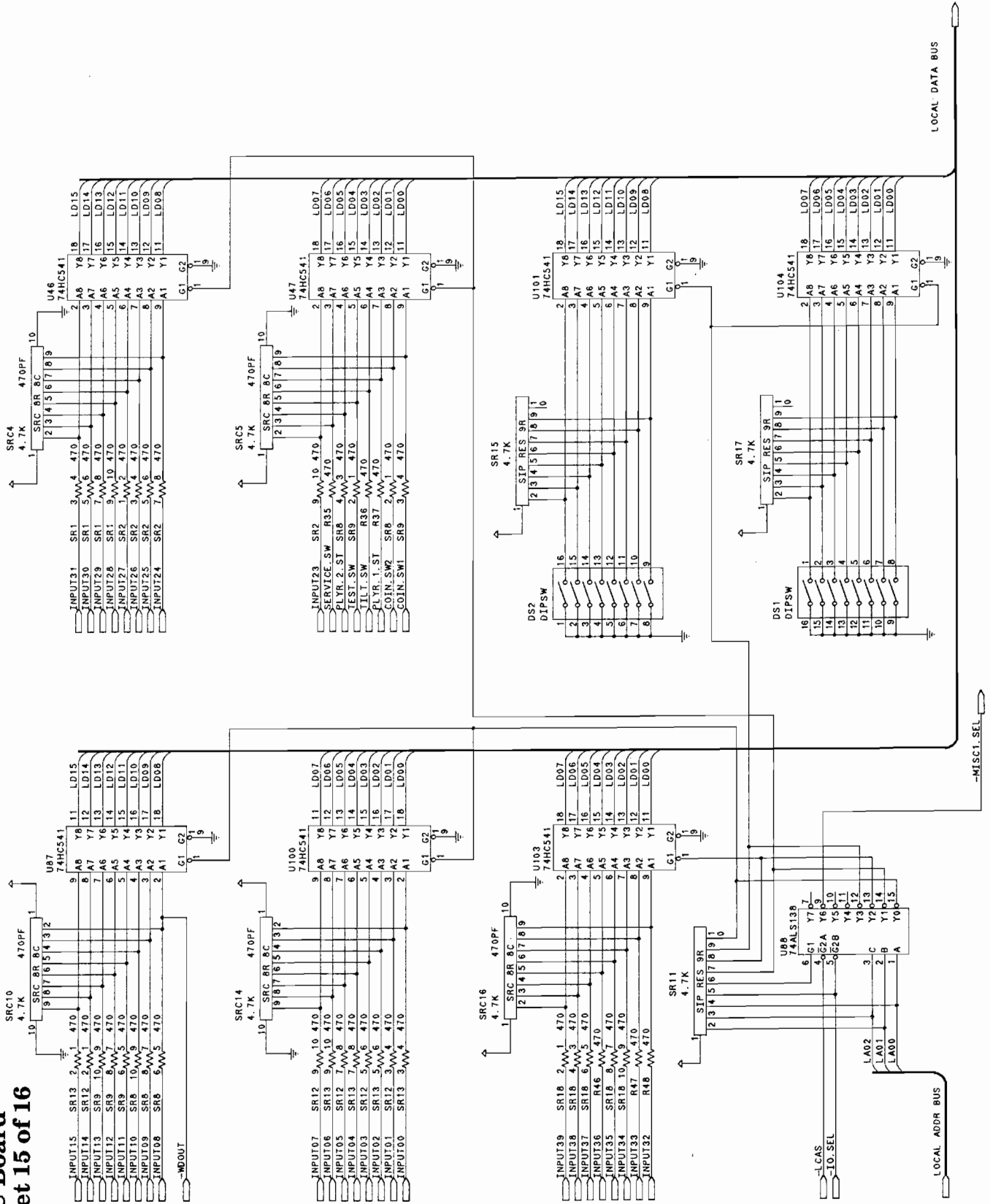

CPU Board sheet 16 of 16

JANMA INTERFACE

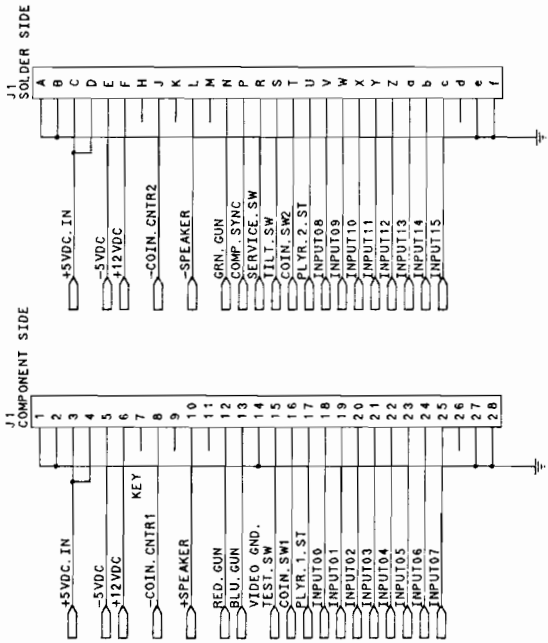

INTERRUPT INTERFACE

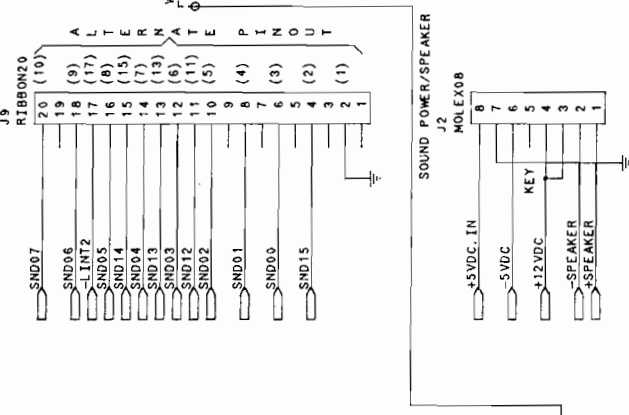

SOUND BOARD INTERFACE

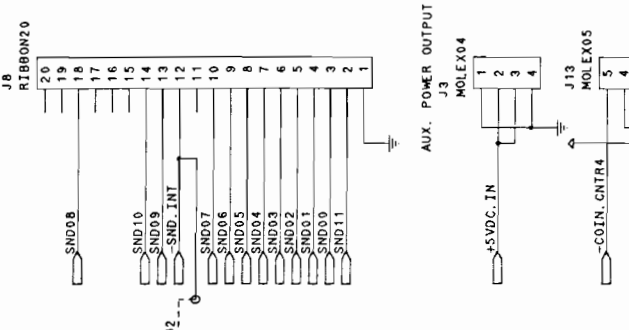

ADDITIONAL INPUTS

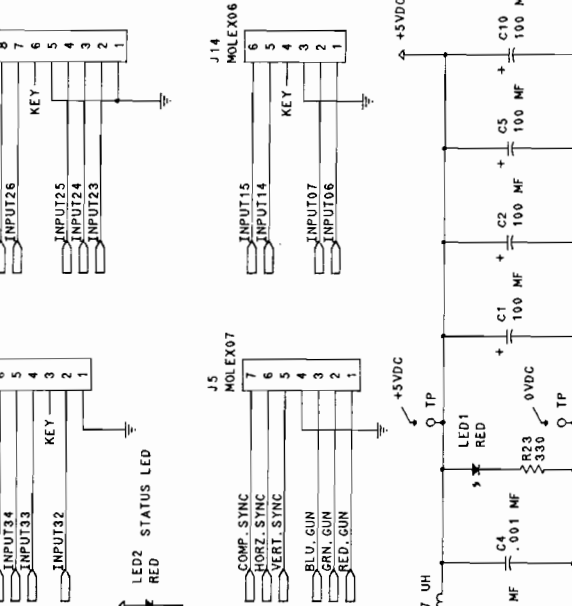
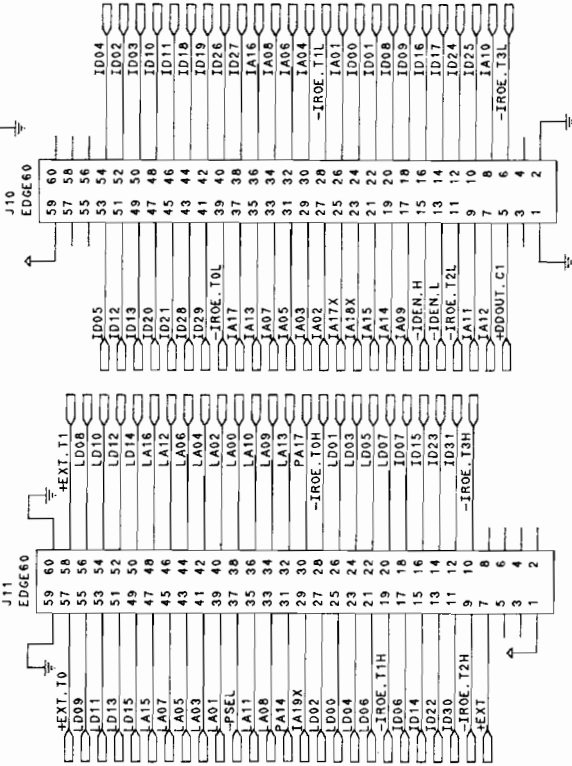
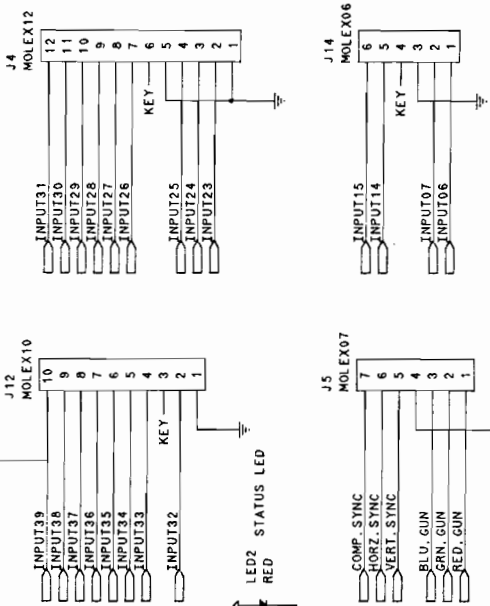

JAMMA Chart

FUNCTION	WIRE COLOR	PIN	PIN	WIRE COLOR	FUNCTION
Ground	Blk	1	A	Blk	Ground
Ground	BLK	2	B	Blk	Ground
+5 Volts DC	Gry	3	C	Gry	+5 Volts DC
+5 Volts DC	Gry	4	D	Gry	+5 Volts DC
-5 Volts DC	Gry-Grn	5	E	Gry-Grn	-5 Volts DC
+12 Volts DC	Gry-Yel	6	F	Gry-Yel	+12 Volts DC
	Key	7	H	Key	
Counter 1 *	Wht-Orn	8	J	Wht-Grn	Counter 2 *
	NC	9	K	NC	
Speaker (+)	Red-Vio	10	L	Grn-Vio	Speaker (-)
	NC	11	M	NC	
Video Red	Red	12	N	Grn	Video Grn
Video Blue	Brn	13	P	Wht	Video Sync
Video Grd	Shield	14	R	Wht-Red	Service Credit *
Test *	Grn	15	S	Wht-Vio	Slam Tilt *
1 Coin (Left)	Wht-Blu	16	T	Yel-Wht	2 Coin (Right)
1 Start/Transform	Yel-Grn	17	U	Yel-Blu	2 Start/Transform
1 Up Move	Org-Blk	18	V	Yel-Blk	2 Up Move
1 Down Move	Org-Brn	19	W	Yel-Brn	2 Down Move
1 Left Move	Org-Red	20	X	Yel-Red	2 Left Move
1 Right Move	Org	21	Y	Yel-Org	2 Right Move
1 Fire	Org-Yel	22	Z	Yel-Vio	2 Fire
1 Weapon	Org-Grn	23	a	Yel-Gry	2 Weapon
1 Weapon Select	Org-Blu	24	b	Vio-Blk	2 Weapon Select
NC	Org-Vio	25	c	Vio-Brn	NC
NC	Org-Gry	26	d	Vio-Red	NC
	NC	27	e	BLK	Ground
Ground	Blk	28	f	Blk	Ground

* Optional function - Game will operate without these connected.

CABINET WIRING

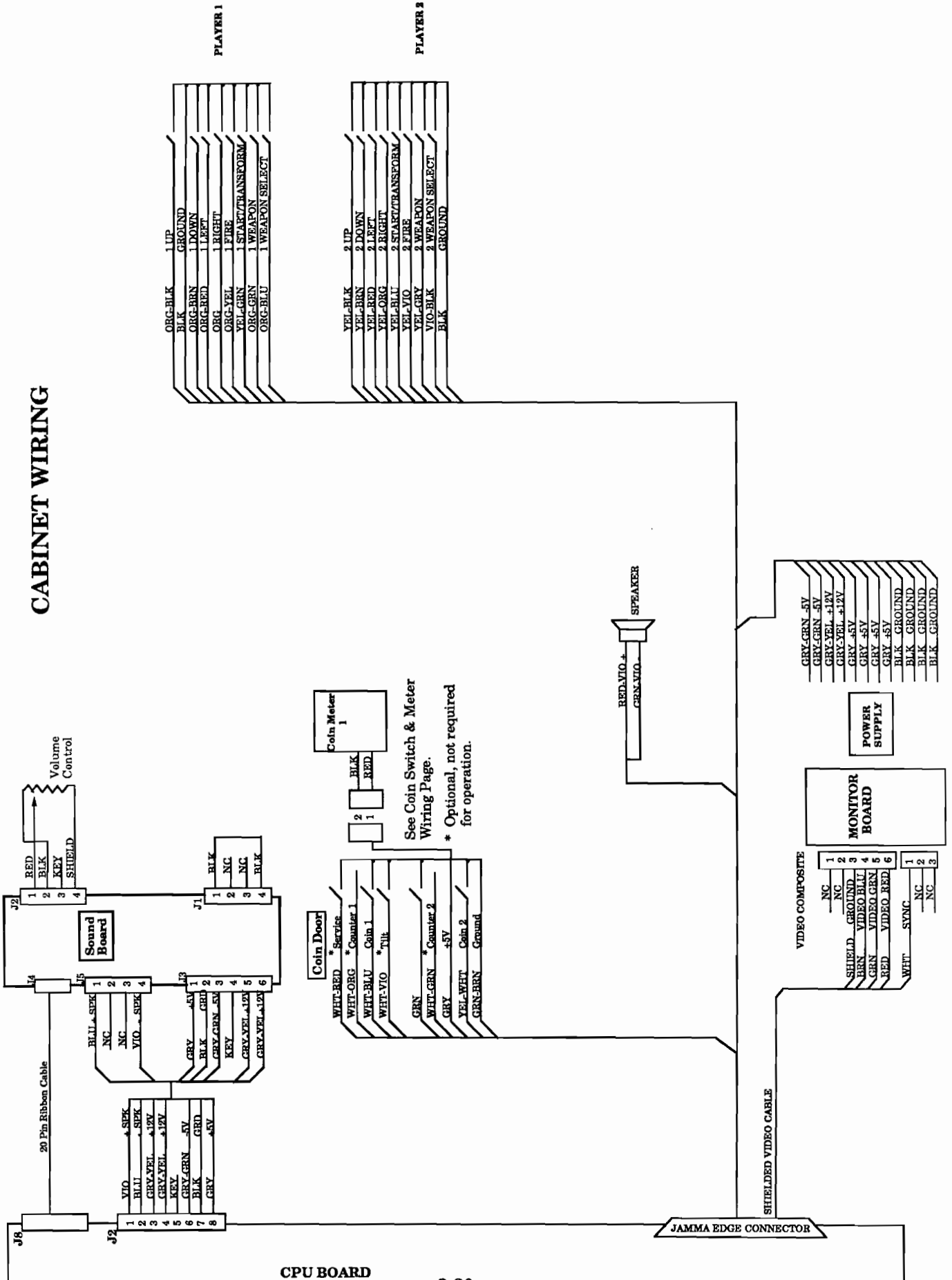

Coin Switch and Meter Wiring

Option 1

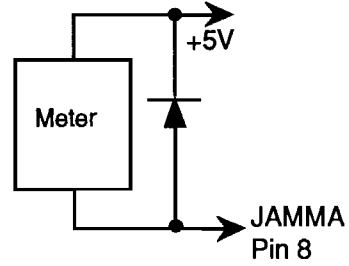
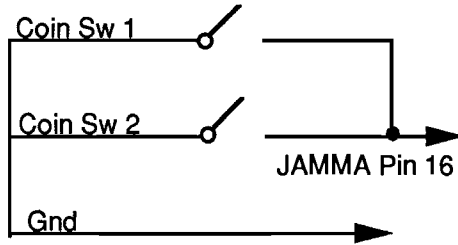

Option 2

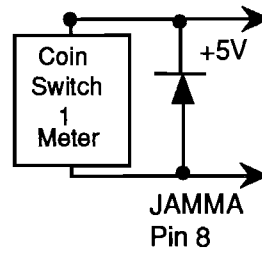
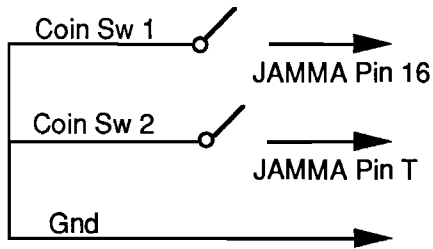

Wrong Way !

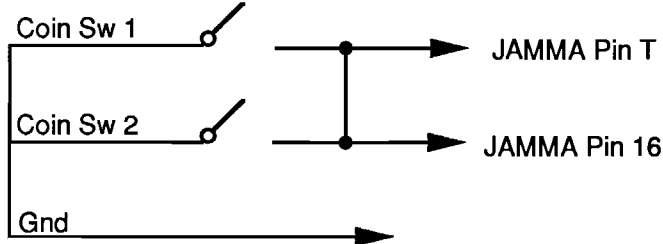

**Do NOT Connect the coin switches this way.
This Circuit is INCORRECT and will cause twice as
many credits per coin.**

INTERBOARD WIRING

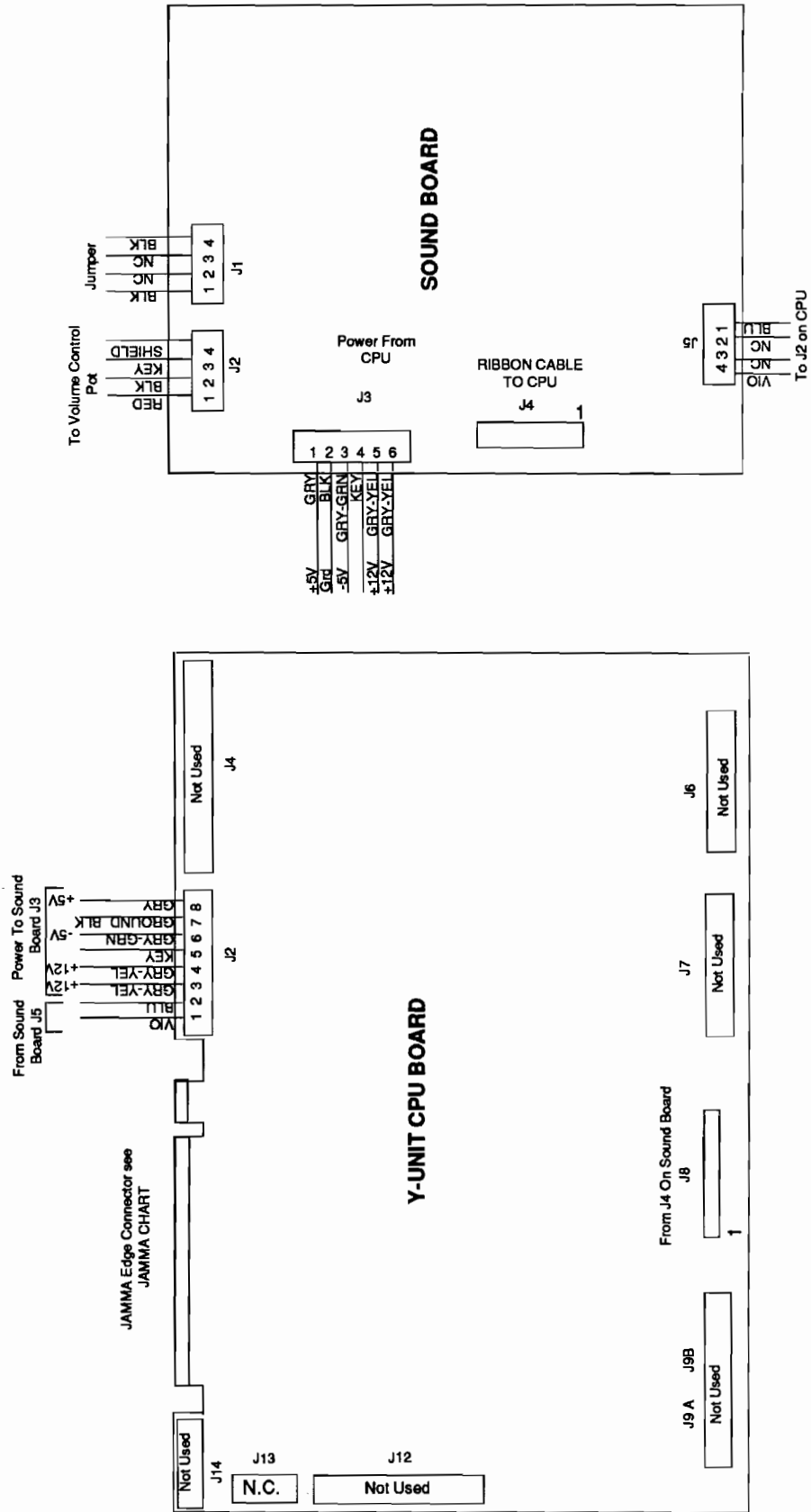

Control Panel Wire Colors

Player 1

Start/Transform
Yellow-Green
Black

Move Up
Orange-Black
Black

Move Down
Orange-Brown
Black

Move Left
Orange-Red
Black

Move Right
Orange
Black

Fire
Orange-Yellow
Black

Weapon
Orange-Green
Black

Weapon Select
Orange-Blue
Black

Player 2

Start/Transform
Yellow-Blue
Black

Move Up
Yellow-Black
Black

Move Down
Yellow-Brown
Black

Move Left
Yellow-Red
Black

Move Right
Yellow-Orange
Black

Fire
Yellow-Violet
Black

Weapon
Yellow-Gray
Black

Weapon Select
Violet-Black
Black

Note: Black is switch ground.

NOTES

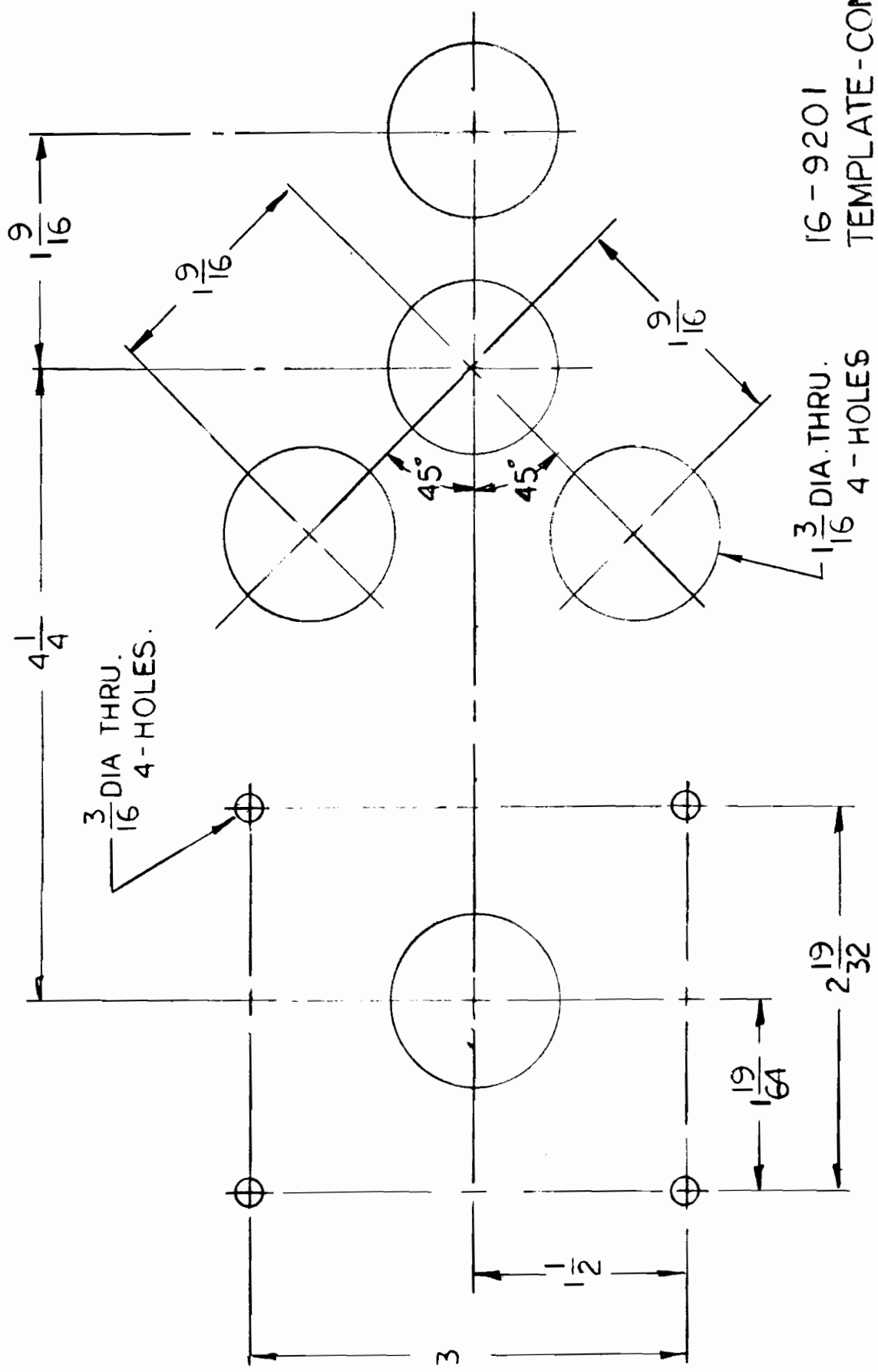

16 - 9201
 TEMPLATE-CONTROLS
 USED ON 42413 KIT

Inserted Jumpers

Audio Board

**W2
W9
W11**

CPU Video Board

**W2, W8, W11, W12
W14, W21, W22, W24
W27, W28, W31, W32
W35, W37, W39, W41
W43, W44, W46, W48
W50, W52, W54, W56
W58, W60, W62, W66
W68, W69, W72, W74
W76, W78, W80**

WARNINGS & NOTICES

Warning

USE OF NON-MIDWAY PARTS OR CIRCUIT MODIFICATIONS MAY CAUSE SERIOUS INJURY OR EQUIPMENT DAMAGE! USE ONLY MIDWAY AUTHORIZED PARTS.

* For safety and reliability, substitute parts and modifications are not recommended.

* Substitute parts or modifications may void FCC type acceptance.

* This game is protected by Federal copyright, trademark and patent laws. Unauthorized modifications may be illegal under Federal law. This also applies to MIDWAY logos, designs, publications and assemblies. Moreover, facsimiles of MIDWAY equipment (or any feature thereof) may be illegal under federal law, regardless of whether or not such facsimiles are manufactured with MIDWAY components.

Warning

This equipment generates, uses and can emit radio frequency energy and, if not installed properly and used according to the directions in this manual, may cause interference to radio communications. It has been tested and found to comply with the limits for a Class A computing device pursuant to Subpart J of part 15 of FCC rules which are designed to provide reasonable protection against such interference when operated in a commercial environment. Operation of this equipment in a residential area is likely to cause interference to radio communications, in which the user, at his or her own expense, will be required to take whatever measures may be needed to correct the interference.

Warning

Prevent shock hazard and assure proper game operation. Only plug this game into a properly grounded outlet. Do not use a cheater plug to defeat the power cord's grounding pin. Do not cut off the ground pin.

Notice

When MIDWAY ships a game, it is in compliance with FCC regulations. Your sticker is proof. If the sticker is missing or damaged, legal repercussions to the owner or distributor of the game may result. If your game does not contain an FCC sticker, call MIDWAY immediately.

Notice

No part of this publication may be reproduced by any mechanical, photographic, or electronic process, or in the form of a phonographic recording, nor may be transmitted, or otherwise copied for public or private use, without permission from the publisher.

Notice

Video Game Kits: MIDWAY manufactures video game kits from new and/or remanufactured components which have been checked for compliance with MIDWAYS quality standards. All components of MIDWAYS kits are subject to MIDWAYS warranty provisions.

Entire contents of this manual COPYRIGHT 1991 MIDWAY MANUFACTURING ALL RIGHTS RESERVED

**For Service:
Call your Authorized MIDWAY Distributor.**

**MIDWAY Manufacturing
3401 N. CALIFORNIA AVE.
CHICAGO, ILLINOIS 60618**