

SEGA



Naomi GD-Rom System

Universal Kit

Kit Installation Instructions
& Service Manual

Switchable **FROM** High Resolution 31K
TO Standard (Low) Resolution 15.75K.

2 PLAYER GAME

- (2) 8-Way Joystick per player
- (2) Action Buttons per player
- (1) Start Button per player

for a **Horizontal Monitor**

Kit come with one (1) JVS/JAMMA Interface Board
for **two (2) Player Action.**

Warranty

Your new Sega Product is covered for a period of 90 days from the date of shipment. This certifies that the Printed Circuit Boards, Power Supplies and Monitor are to be free of defects in workmanship or materials under normal operating conditions. This also certifies that all Interactive Control Assemblies are to be free from defects in workmanship and materials under normal operating conditions. No other product in this machine is hereby covered.

Sellers sole liability in the event a warranted part described above fails shall be, at its option, to replace or repair the defective part during the warranty period. For Warranty claims, contact your Sega Distributor.

Should the Seller determine, by inspection that the product was caused by Accident, Misuse, Neglect, Alteration, Improper Repair, Installation or Testing, the warranty offered will be null and void.

Under no circumstances is the Seller responsible for any loss of profits, loss of use, or other damages.

This shall be the exclusive written Warranty of the original purchaser expressed in lieu of all other warranties expressed or implied. Under no circumstance shall it extend beyond the period of time listed above.

FIG. 1

Kit Overview

AC Power Cable
(GRN/WHT & BLK)

Volume/
Speaker/
Coin Meter
Cable

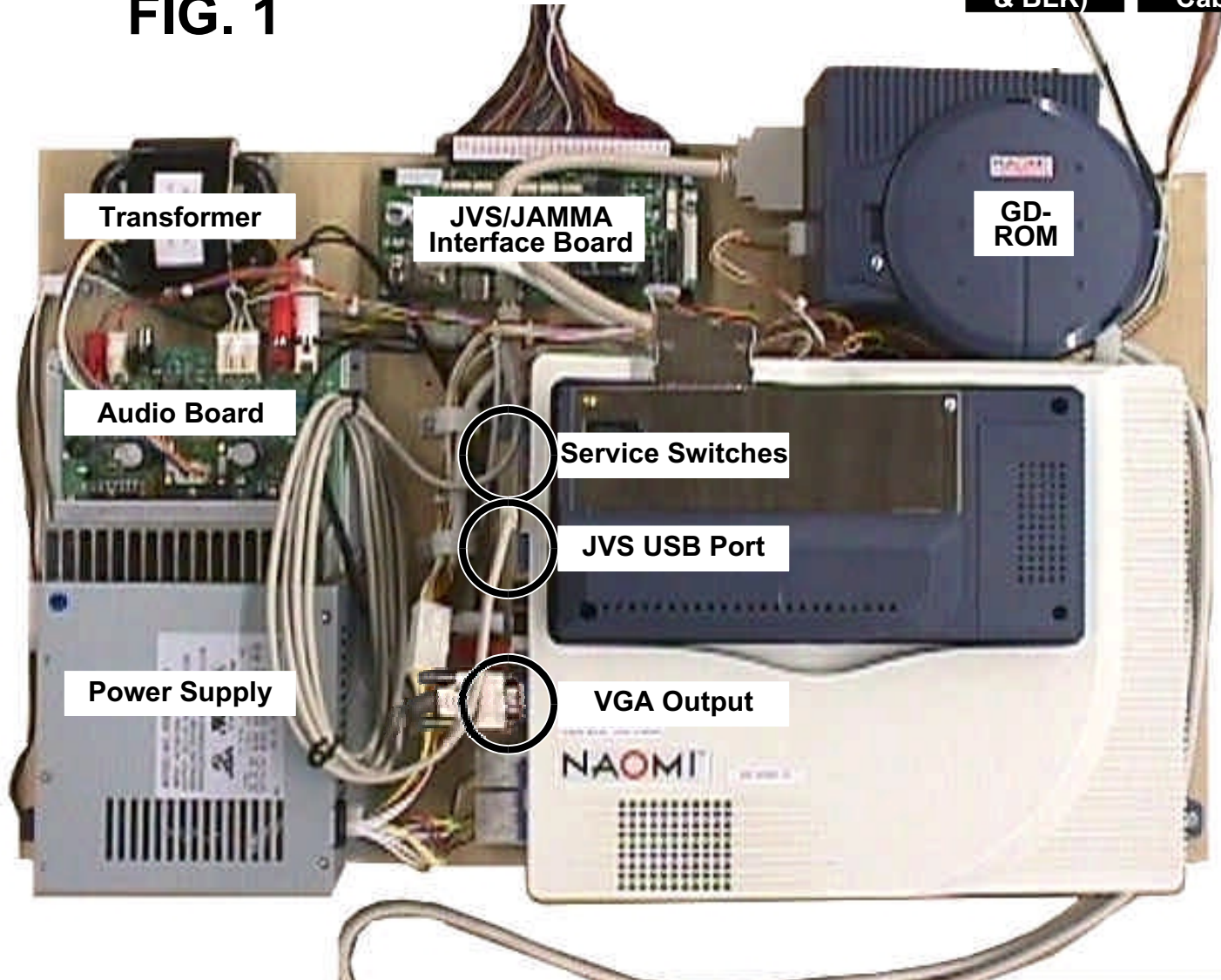

Button Layout Overview (See Templates on Page VII)

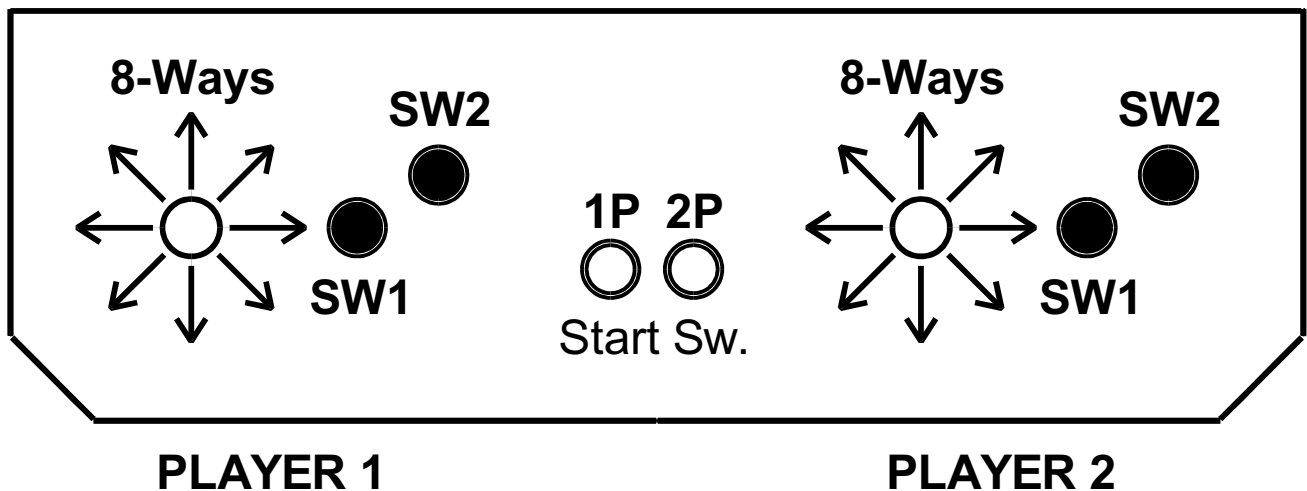

INSTALLATION INSTRUCTIONS

- 1) First. Remove all access panels from the game. Locate the original game Logic PCB's & Power Supply and remove from the Cabinet by first disconnecting all harnesses from the boards. (You need only to splice in the Main Power (110v AC) into the 3-Pin Connector (GRN/WHT/BLK).)
- 2) Remove all existing game harnesses (we suggest using New Jamma Harnesses (*NOT contained in the kit*) to ensure reliability).
- 3) Locate the most convenient and open area of the cabinet to mount the Sports Jam GD-Rom System Asm. Make sure this area is free and clear of all cable harnesses and grounds, cable clamps, etc. (See **FIG. 1, inside cover**).

Vacuum out or clean bottom of cabinet of dirt & miscellaneous parts (e.g. screws, loose coins / tokens, etc.).



Remove all exterior decals and repair any cabinet damage. Repaint cabinet if necessary. Remove the Monitor Plexi or if your game plexi has Silk-screened artwork, you will need to strip it off.

- 4) Connect the JAMMA Harnesses to the JVS-JAMMA Interface Boards. Separate the wires from each other (i.e. Control Panel, Video, Speaker, Power Supply). Run the various harnesses to the part of the cabinet they go to ensuring they are dressed properly & secured to the cabinet. (See **FIG. 4 Pg. iv**). Locate the Volume/Speaker/Coin Meter Cable and connect to your existing **Diag. Switch Bracket** or use the new one included with the kit. (See **FIG. 3, Pg. iii**). **Note:** *If you are using a VGA Compatible Monitor you can run your VGA Cable directly to the monitor or connect it to your JVS JAMMA Interface for RGB Conversion to your JAMMA Cables.*
- 5) Remove Marquee from cabinet and cut to fit the new Sports Jam Marquee in place.

Sports Jam uses 1 Lever (Joystick) with 2 Multi-Function Switches (Buttons) for controls and a Start Button per player. **REPLACE** old Joysticks & Buttons with the **NEW** ones supplied in Kit.



- 6) First remove all Joystick and Button assemblies from the Control Panel. Remove Lexan and Control Panel Overlay. Proceed to clean surface of the Control Panel by removing all adhesive and dirt. Fill in or plug up existing button holes to set up a blank work area for your (1 - 2) templates (See **Pages VII, COPY & CUT**).
- 7) Carefully tape template on the Control Panel in configuration of 2 players; using a Center Punch, mark your hole centers. With a 1c" Hole - Saw, proceed to drill out holes for the new Control Panel configuration. Once drilling is complete, clean surface once again eliminating all wood chips and dust.
- 8) Install the new Control Panel Overlay by carefully peeling off the paper backing and laying down on the panel. Smooth it out, starting in the center and working your way to the edges (removing all of the trapped air pockets). If necessary, cut the edges of the overlay excess and fold under panel.
- 9) Cut out the button and Joystick Holes. Install Joystick and buttons from kit into the Control Panel and tighten down. Connect all game harness wires to switches and buttons.

INSTALLATION INSTRUCTIONS

10) Proceed to place new decals on the sides of the cabinet. Locate a new monitor bezel, if needed, and replace glass, if required (due scratches). Install Instruction Placard to the back of the Monitor Glass.

NOTE: As a precaution, disconnect the JAMMA Harness from the I/O Boards and turn power on. With a Multi-Meter, measure the 5v and adjust if necessary to 5.15v DC. Measure the +12 to ensure the wires and voltages are in the correct position. Turn power off. Plug in the JAMMA Harness once again to the I/O Boards. The Attract Mode should appear on the screen.

Adjust the **SIZE, CONTRAST, BRIGHTNESS, and COLORS** on the Monitor for optimum appearance. Adjust **VERTICAL/HORIZONTAL Hold** to get a stable picture, if required.



Good Idea!



Good Idea!

Enter **DIAGNOSTICS** and adjust the Volume Level, test all Buttons & Joystick for proper operation & wiring. Adjust Pricing. Coin-Up and test out a game to ensure proper play functions are as they should be.

Sega Naomi System Switch Bracket and Speaker Installation Diagrams (Figure 3)

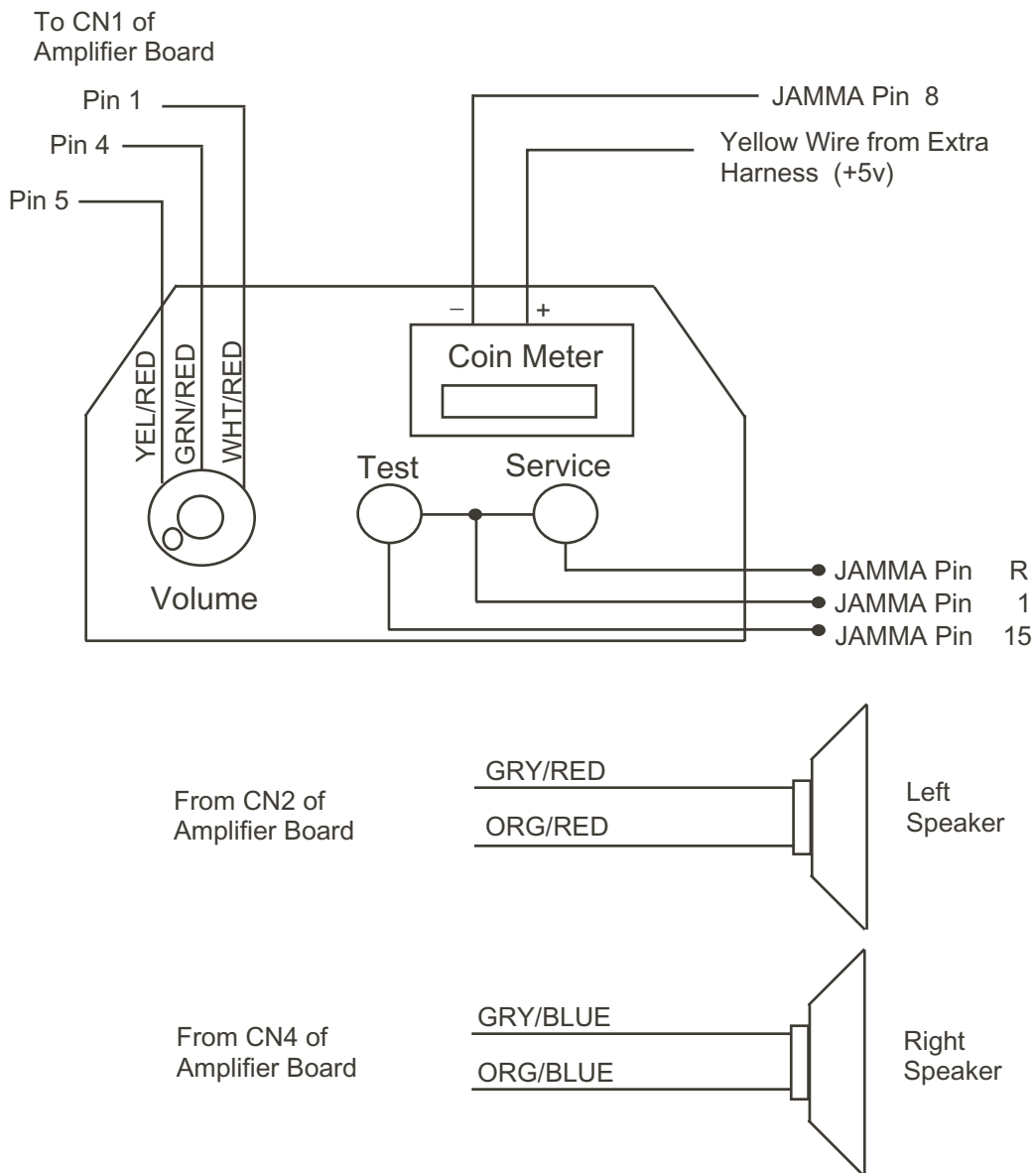

Sega Naomi System JAMMA Harness Wiring (JAMMA I/O BD)

(Figure 4)

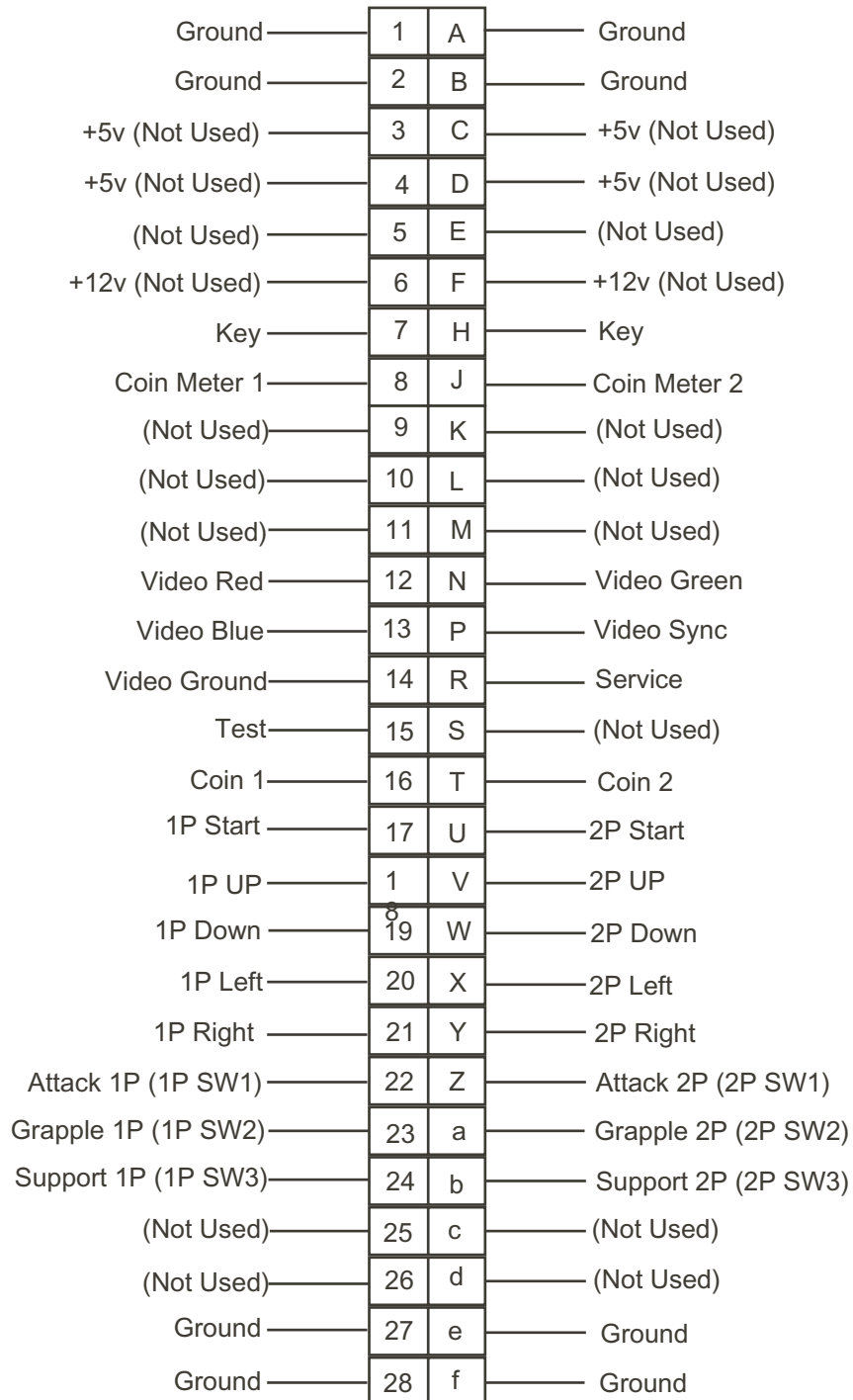

Sega Naomi System Filter Board Information Connector Description etc.

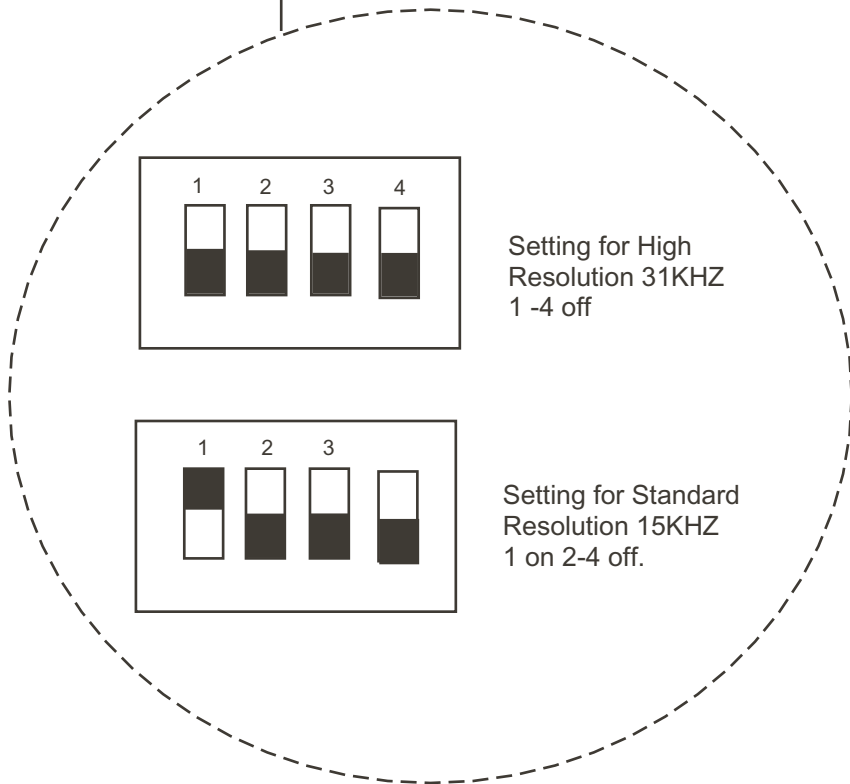
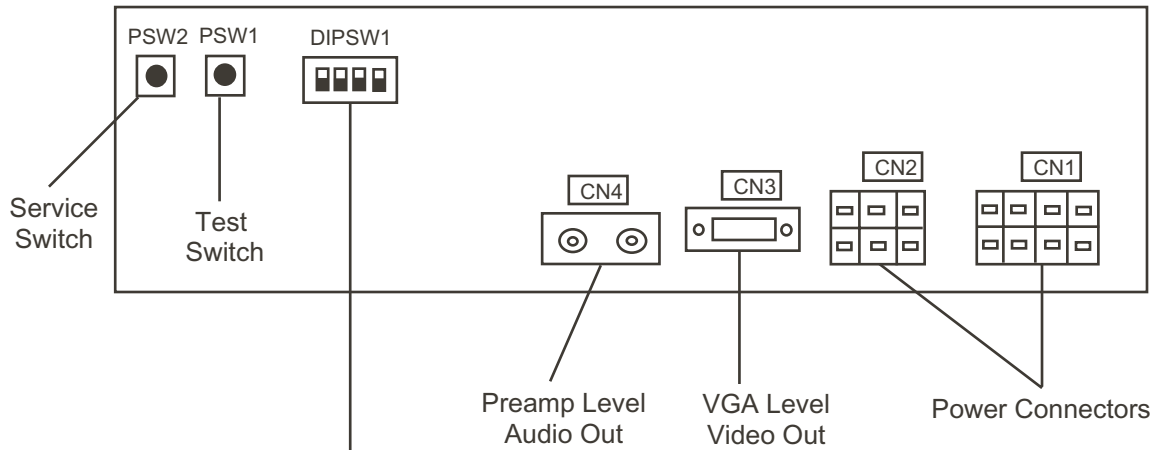



BUTTON LAYOUT CONFIGURATION

Below are *Actual Size Templates* for
PROPER ERGONOMIC PLACEMENT
of your *Control Panel Buttons*.

(Copy this page to cut templates at dotted lines.)

Cut Copied Page Only



LEVER
(JOYSTICK)

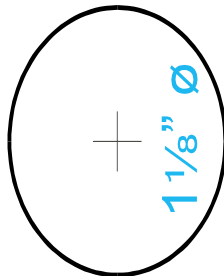

**Typical Hole Saw
Diameter = 1 1/8"**

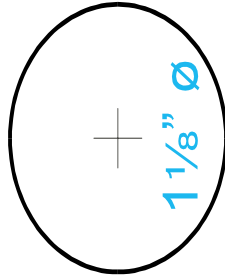

**BUTTON
"SW1"**
(Switch 1)

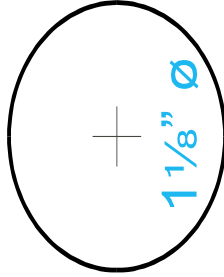

**BUTTON
"SW2"**
(Switch 2)



LEVER
(JOYSTICK)

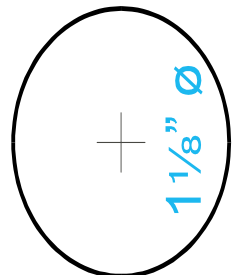

**Typical Hole Saw
Diameter = 1 1/8"**

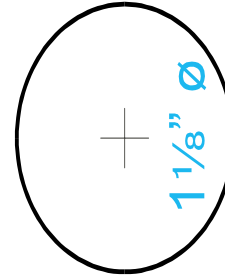

**BUTTON
"SW1"**
(Switch 1)

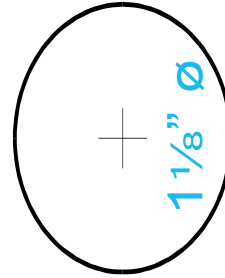

**BUTTON
"SW2"**
(Switch 2)

THIS PAGE INTENTIONALLY BLANK

TABLE OF CONTENTS

BEFORE USING THE PRODUCT, BE SURE TO READ THE FOLLOWING:

1. HANDLING PRECAUTIONS	1
2. SPECIFICATIONS	2
3. CONTENTS OF GAME	3
4. TEST MODE	7
A.SYSTEM MENU	
B.GAME TEST MODE	
a.INPUT TEST	
Switch input test is performed.	
b.GAME ASSIGNMENTS	
Various settings such as game difficulty, etc. can be set.	
c.BOOKKEEPING	
Allows for checking data such as the number of coins inserted, operation time, game time, etc.	
d.BACKUP DATA CLEAR	
Clears the contents of BOOKKEEPING.	
5. GAME BOARD	14
6. SOFT KIT	16

Use of this product is unlikely to cause physical injuries or damages to property. However, where special attention is required this is indicated by a thick line, the word "IMPORTANT" and its sign in this manual.



IMPORTANT

Indicates that mishandling the product by disregarding this display can cause the product's intrinsic performance not to be obtained, resulting in malfunctioning.



IMPORTANT

- When using the cabinet that shares the coin chute between 1P and 2P (such as the NAOMI CABINET, BLAST CITY, etc.), change the setting of the COIN CHUTE TYPE item in the COIN ASSIGNMENTS screen, from INDIVIDUAL to COMMON. Using these cabinets with the setting of INDIVIDUAL disables to play from the 2P side.
For more information about the COIN ASSIGNMENTS screen, see the Naomi Service Manual.
- When having connected the power for the first time, open the SYSTEM MENU - GAME TEST MODE - INPUT TEST screen and test the input devices; thereby make sure that they can function normally.
- This game is available only with the NAOMI GD-ROM system. It is not available with other hardware.
- This game cannot support the competitor connection kit of the NAOMI CABINET. When connecting the wire to the control panel, therefore, connect it only to a single I/O board.

1. HANDLING PRECAUTIONS



WARNING!

- To prevent electric shock or IC Board malfunctioning, be sure to turn off the power for the cabinet when installing or removing the IC Board.
- Extraneous matter such as dust on the IC Board can cause the IC Board to generate heat and result in a fire due to short circuit, etc. Ensure the IC Board surfaces are always kept clean.
- Use NAOMI for the cabinets compatible with JVS. Using NAOMI for the cabinet other than those compatible with JVS can cause generation of heat and a fire.



IMPORTANT

- Be sure to connect the IC Board and connectors completely. Insufficient insertion can damage IC Board, etc.
- For the IC Board circuit inspection, only the use of Logic Tester is permitted. The use of ordinary testers is not permitted as these can damage the IC Board.
- Do not subject the IC Board to static electricity when installing the IC Board in the cabinet or when connecting wire harness connectors to the IC Board.
- When soldering buttons, etc. to the wire harnesses, be sure to remove the wire harnesses from the IC Board so as not to subject the IC Board to heat.
- Using NAOMI without the Shield Case can cause electric wave trouble. Be sure to use NAOMI together with the accessory Shield Case.
- The monitor frequency corresponding to NAOMI is 15kHz or 31kHz. NAOMI can not be used for the cabinet incorporating a monitor or projector not corresponding to 15kHz or 31kHz.

- Concerning the display of JAMMA VIDEO STANDARD:
JAMMA VIDEO STANDARD adopted by NAOMI is referred to as JVS. As against this Standard, the conventional JAMMA STANDARD which employs 56P Edge Connectors adopted by ST-V, etc. is displayed as Old JAMMA STANDARD.

The specific Manual attached to each game sometimes displays JVS as JV STANDARD, New JAMMA STANDARD, or JAMMA 2 STANDARD AGAINST OLD JAMMA STANDARD as JAMMA STANDARD, JS, etc.

- The contents herein described are subject to change without notice.

2. SPECIFICATIONS

① ON-SCREEN DISPLAY

Monitor Position



Synchronous Frequency
15/31 kHz

② CONTROL PANEL

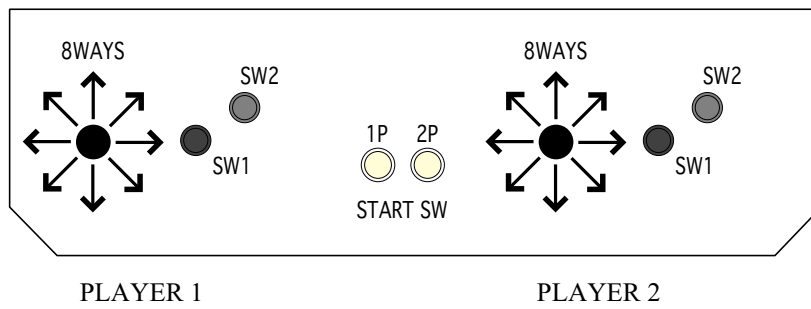

③ Minimum DIMM Memory Capacity

256 MB

3. HOW TO PLAY THE GAME

Introduction to the Game

A player plays the most popular sports in the world (8 events and 12 games). The player aims to take first money and thereby to be designated as a KING OF SPORTS.

Stages toward a KING OF SPORTS

Following the 3 stages, a player ventures to play the events, one each on a stage. Then the player moves to a final stage and chooses the best event out of the finished 3 events so as to be designated a KING OF SPORTS.

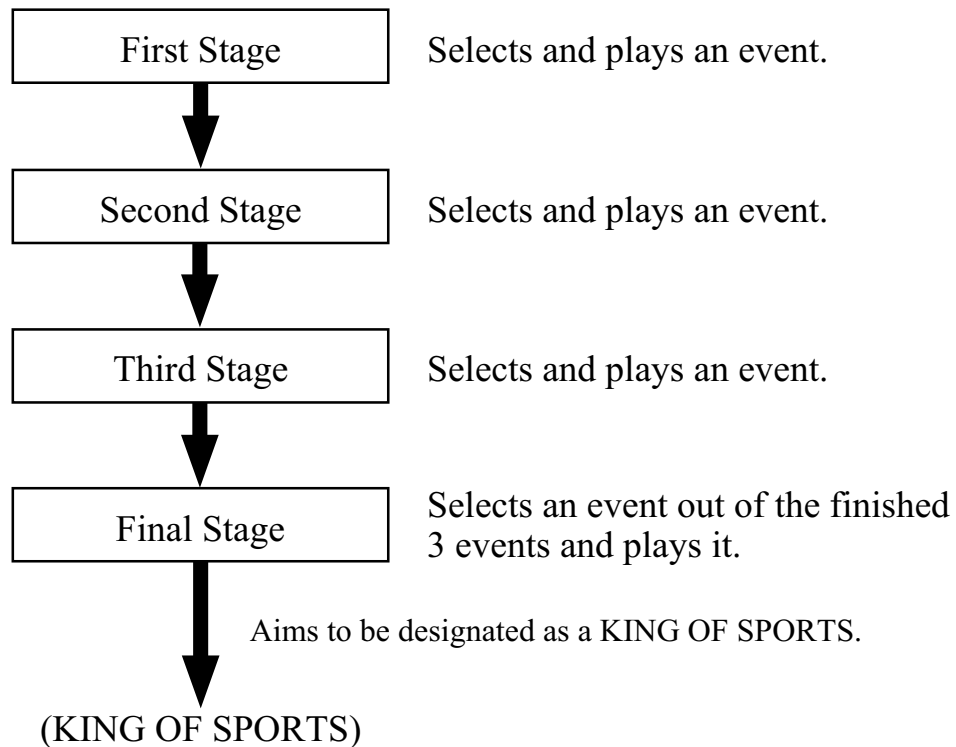

Games and Operation (1)



3Points Shoot Out
BASKETBALL

The player tries to shoot, within a limited time, from the 5 positions in the three-point field.



The Great Slugger
BASEBALL

The player tries to hit a home run into an outfield stands.



Touch Down Derby
FOOTBALL

The two players try to compete for a touchdown.



Near Pin Contest
GOLF

The player tries to tee off the ball nearest to the pin.



Long shoot
SOCCER

The player tries to score a goal with a long shoot.



Computer Receive
TENNIS

The player tries to receive the ball back into the target in the displayed court.



Computer Receive
TENNIS

The two players try to rally.



Direct Ace
SOCCER

The player tries to score a goal with a direct shoot.

Games and Operation (2)



The player tries to sprint around the track two times for the shortest time.



The player tries to putt.



The player tries to score a field goal.



The player, as a goalie, tries to save the shots as many as possible.



Special Command

A special command is available to enable a player to select all the games at the beginning (not one stage by one stage).

To activate the special command:

When a shutter is going to open after the coins have been inserted, move the control stick upward, downward, rightward, and leftward, and then press the SW1 and SW2 switches - all in this order.

Instructions on the Screen

■ When in a 1-person play:

The game is over if the player fails to satisfy the clearing condition within a specified time interval.

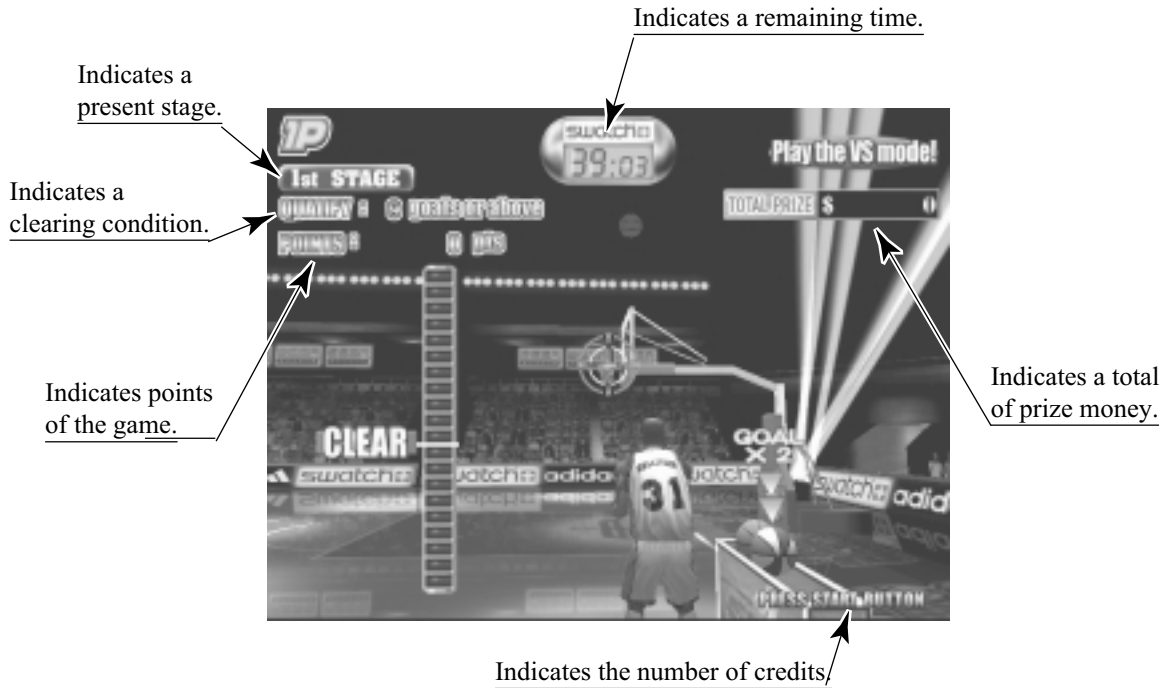

■ When in a 2-person play:

The player who has won the two matches is a winner.
 If both the players have equal scores, the result of the game is decided with a sudden death rule. (If the result can not be decided even with a sudden death rule, the game is over.)

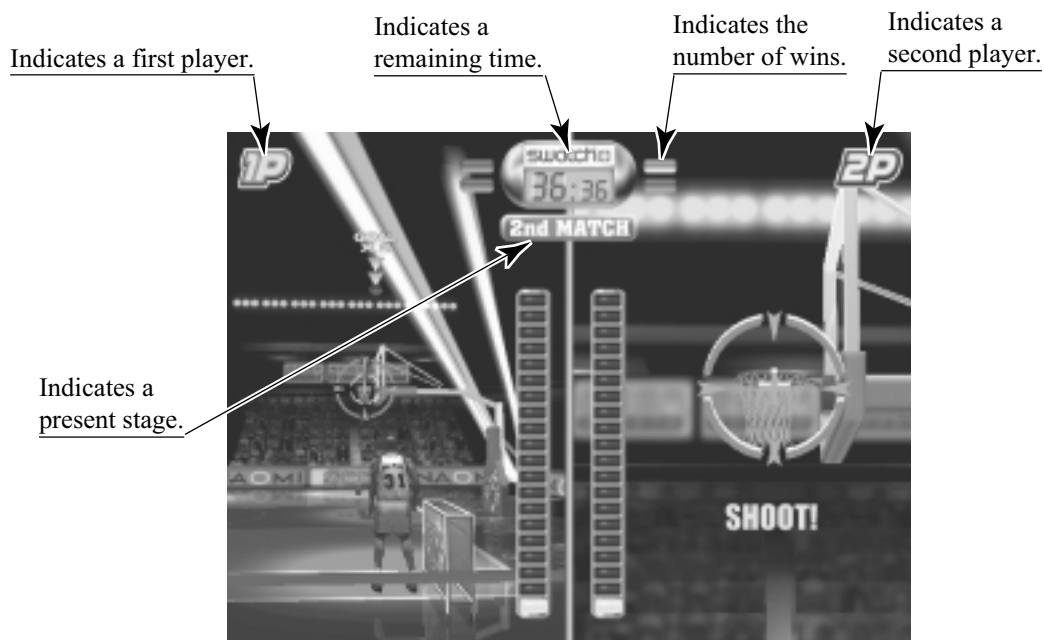

4. TEST MODE

A. SYSTEM MENU



When settings are changed in SYSTEM ASSIGNMENTS, COIN ASSIGNMENTS, and GAME ASSIGNMENTS of GAME TEST MODE, be sure to exit from the test mode of SYSTEM MENU screen. The contents of setting changes are stored in the IC on the BOARD when exiting from the Test Mode. If the power is turned off in the Test Mode (before exiting), the contents of setting changes are ineffective. In this case, the settings remain unchanged.

This test mode mainly allows the IC Board to be checked for accurate functioning, monitor color to be adjusted as well as COIN ASSIGNMENTS and GAME ASSIGNMENTS to be adjusted.

- 1) Connect the power, and press the test button. Then the following SYSTEM MENU screen appears.

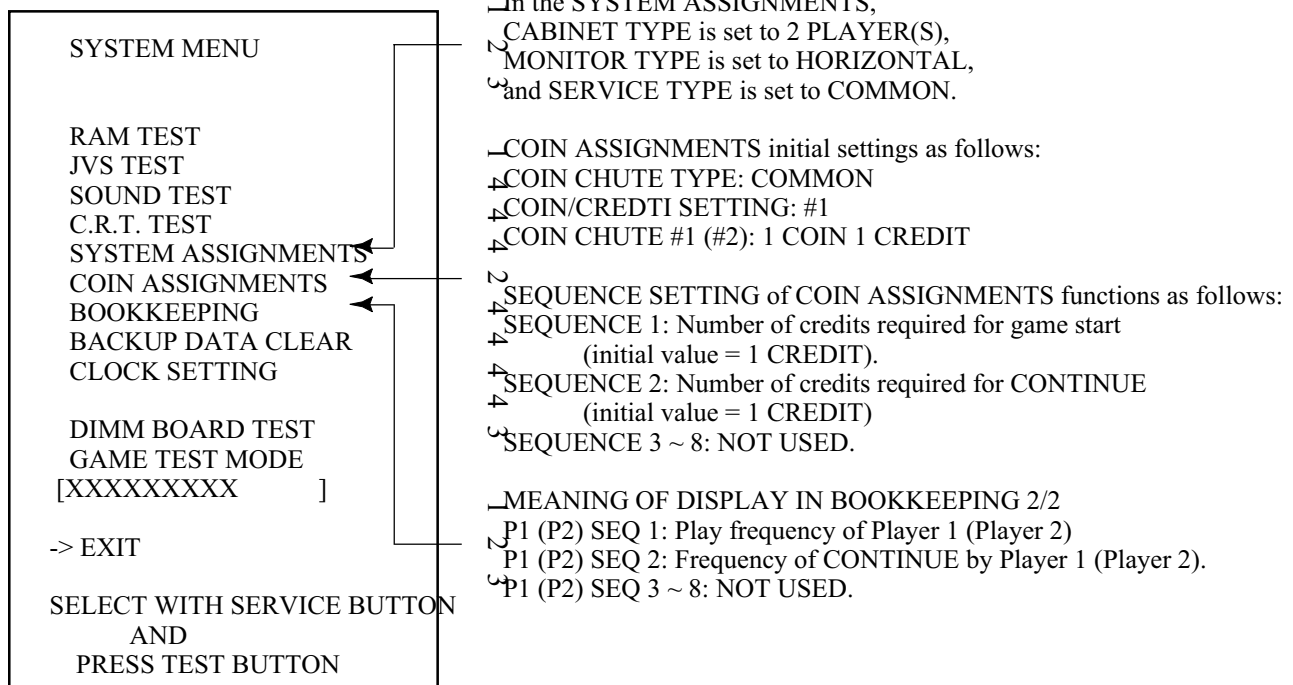

- 2) Press the service button to move the -> mark to any desired item, and press the test button.
- 3) Press the service button to move the -> mark to GAME TEST MODE item, and press the test button. Then the GAME TEST MENU screen appears that enables to test the items specific to this game. For the details, see the following pages.
- 4) After testing, select the EXIT and press the test button. The game advertising screen reappears.

NOTE: For more information about the SYSTEM MENU screen, see the GD-ROM Service Manual (No.: 420-6620-01).

B. GAME TEST MODE

Press the service button to move the -> mark to any desired item, and press the test button. Then the corresponding screen appears.

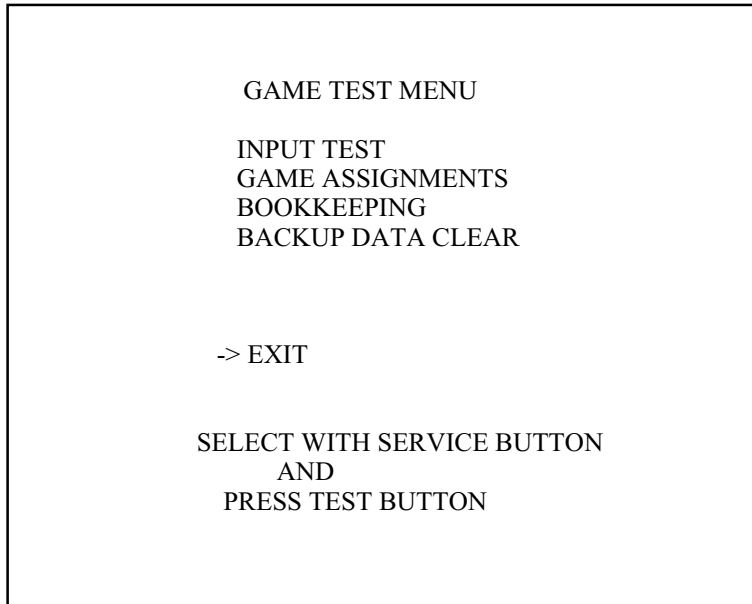

GAME TEST MENU Screen

After testing, select the EXIT and press the test button. Then the SYSTEM MENU screen reappears.

a. INPUT TEST

This screen tests the input devices. Make sure that each of the input devices can change its indication from OFF to ON as you operate the corresponding device.

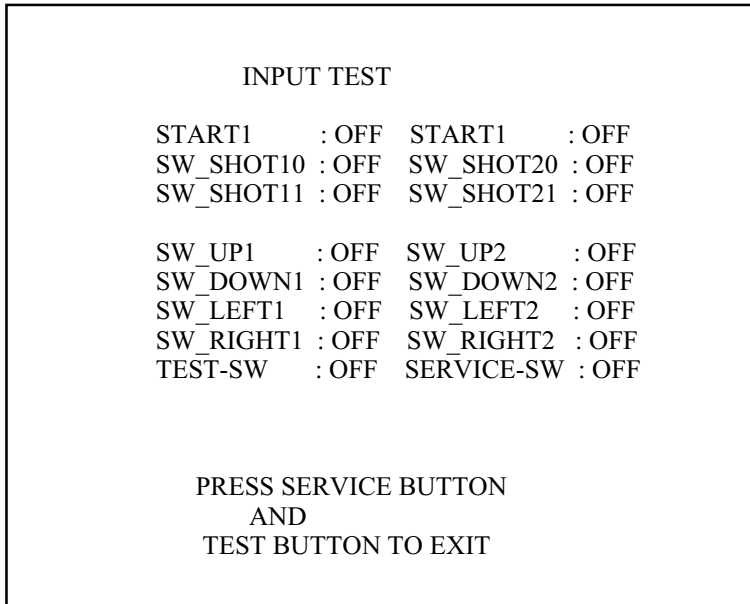

INPUT TEST Screen

After testing, press the test button and the service button simultaneously. Then the GAME TEST MENU screen reappears.

CONTROL PANEL

b. GAME ASSIGNMENTS

This screen sets the game difficulty level.

Press the service button to move the -> mark to the GAME DIFFICULTY item, and press the test button. Then the GAME DIFFICULTY item can change its indication between VERY EASY, EASY, MEDIUM EASY, NORMAL, BIT HARD, MEDIUM HARD, HARD, and VERY HARD.

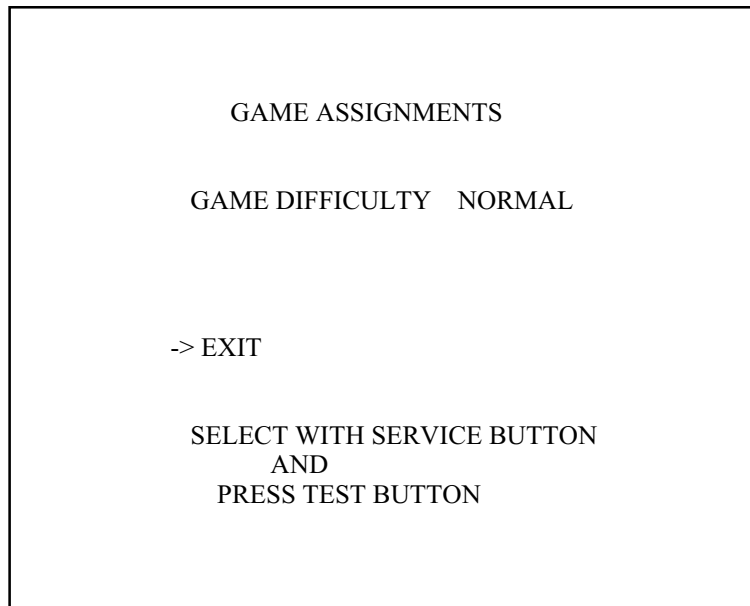

GAME ASSIGNMENTS Screen

After setting, select the EXIT and press the test button. Then the GAME TEST MENU screen reappears.

c. BOOKKEEPING

The following three BOOKKEEPING screens (PAGE 1/3, 2/3, and 3/3) display the operating data.

BOOKKEEPING	
GAME REPORT	PAGE1/3
NUMBER OF GAMES	0
1P GAMES	0
2P GAMES	0
NUMBER OF CONTINUE	0
1P GAMES	0
2P GAMES	0
PLAY	TIME 0D 0H 0M 0S
AVERAGE PLAY TIME	0D 0H 0M 0S
LONGEST PLAY TIME	0D 0H 0M 0S
SHORTEST PLAY TIME	0D 0H 0M 0S
PRESS TEST BUTTON TO CONTINUE	

BOOKKEEPING Screen (1/3)

Press the test button to migrate to the BOOKKEEPING (PAGE 2/3) screen.

This screen (TIME HISTOGRAM) shows the number of the games per every playing period. Use the data to set a difficulty level.

BOOKKEEPING	
TIME HISTOGRAM	PAGE 2/3
0M00S ~ 0M29S	0
0M30S ~ 0M59S	0
1M00S ~ 1M29S	0
1M30S ~ 1M59S	0
2M00S ~ 2M29S	0
2M30S ~ 2M59S	0
3M00S ~ 3M29S	0
3M30S ~ 3M59S	0
4M00S ~ 4M29S	0
4M30S ~ 4M59S	0
5M00S ~ 5M29S	0
5M30S ~ 5M59S	0
6M00S ~ 6M29S	0
6M30S ~ 6M59S	0
7M00S ~ 7M29S	0
7M30S ~ 7M59S	0
8M00S ~ 8M29S	0
8M30S ~ 8M59S	0
9M00S ~ 9M29S	0
9M30S ~ 9M59S	0
OVER 10M00S	0
PRESS TEST BUTTON TO CONTINUE	

BOOKKEEPING Screen (2/3)

Press the test button to migrate to the BOOKKEEPING (PAGE 3/3) screen.

The screen (CALLED GAMES) shows the number of games per every game.

BOOKKEEPING	
CALLED GAMES	PAGE3/3
BASKET	0
AMFB2	0
GOLF	0
GOLF2	0
BASEBALL	0
AMFB	0
SOCCER	0
SOCCER2	0
BICYCLE	0
TENNIS	0
HOCKEY	0
HOCKEY2	0

PRESS TEST BUTTON TO EXIT

BOOKKEEPING Screen (3/3)

Press the test button. Then the GAME TEST MENU screen reappears.

d. BACKUP DATA CLEAR

This screen enables to clear the bookkeeping data and the ranking data.

NOTES:

(1) This BACKUP DATA CLEAR screen cannot clear the game difficulty level setting of the GAME ASSIGNMENT screen.

(2) This BACKUP DATA CLEAR screen cannot clear the coin and credit data. To clear the coin and credit data, select and execute the BACKUP DATA CLEAR item in the SYSTEM MENU screen.

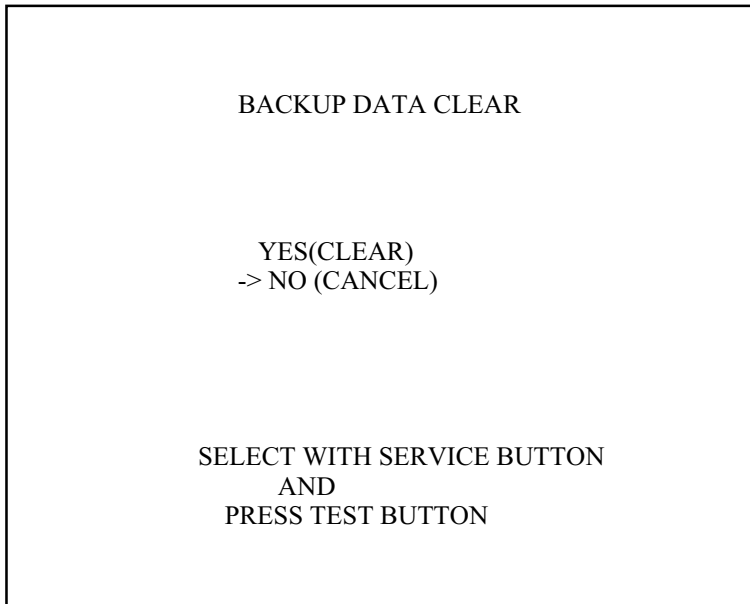

BACKUP DATA CLEAR Screen

To clear the backup data:

Press the service button to move the -> mark to the YES (CLEAR) item, and press the test button. When the system completes clearing, a 'COMPLETED' message appears on the screen. Press the test button again to return to the GAME TEST MENU screen.

Not to clear the backup data:

Press the service button to move the -> mark to the NO (CANCEL) item, and press the test button. The system does not execute clearing, but returns to the GAME TEST MENU screen.

5. GAME BOARD



- Do not expose the Game Board so as to avoid causing an accident or malfunctioning.
- Static electricity discharge can damage electronic parts on the IC Board. Before starting work by opening the Shield Case Lid, be sure to touch grounded metallic surfaces to discharge physically charged static electricity.
- When replacing the Game Board, refer to the CVT Manual and Instruction Manual.

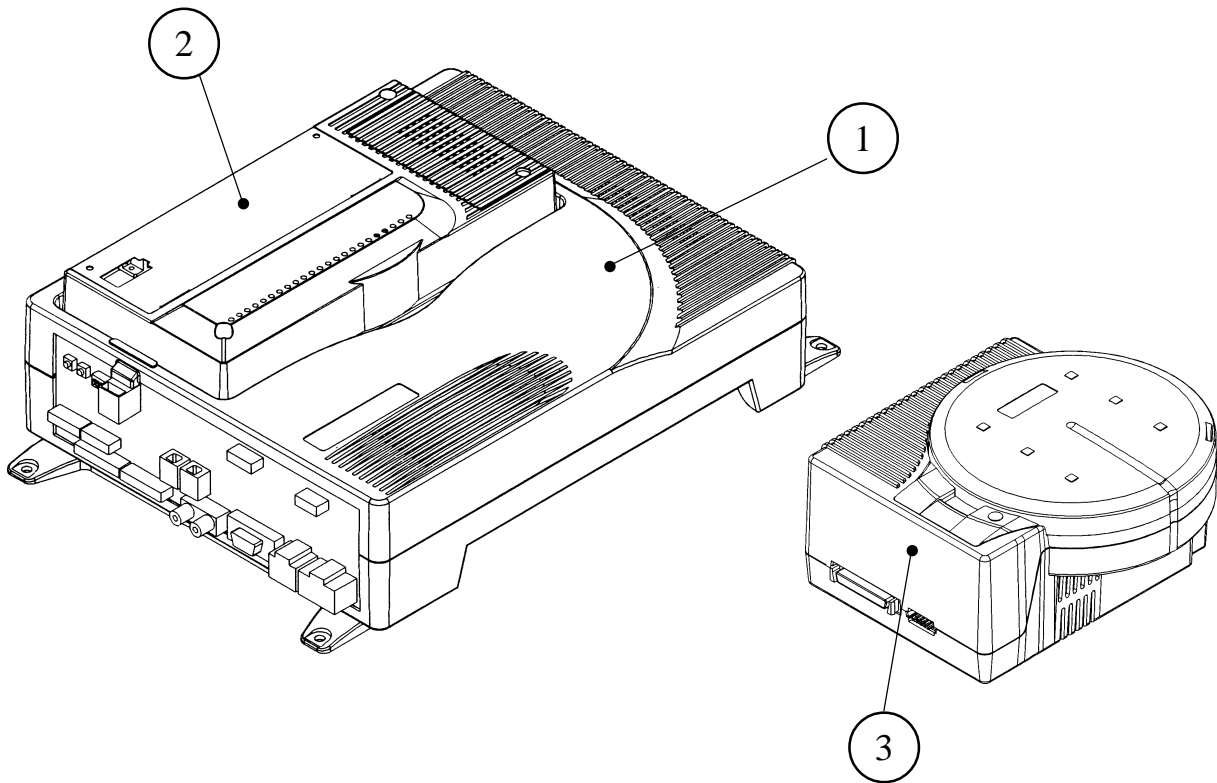

	PART NO.	DESCRIPTION
① + ②	840-0051D-01 840-0051D-02 840-0051D-03 840-0051D-04	ASSY CASE NAO PCI DIMM BD USA ASSY CASE NAO PCI DIMM BD EXP ASSY CASE NAO PCI DIMM BD KOR ASSY CASE NAO PCI DIMM BD AUS
①	840-0001A-01 840-0001A-02 840-0001A-03 840-0001A-04	ASSY CASE NAOMI MAIN BD USA ASSY CASE NAOMI MAIN BD EXP ASSY CASE NAOMI MAIN BD KOR ASSY CASE NAOMI MAIN BD AUS
②	840-0001F	ASSY CASE NAO DIMM BD COM
③	610-0617	GD-ROM DRIVE UNIT NAOMI

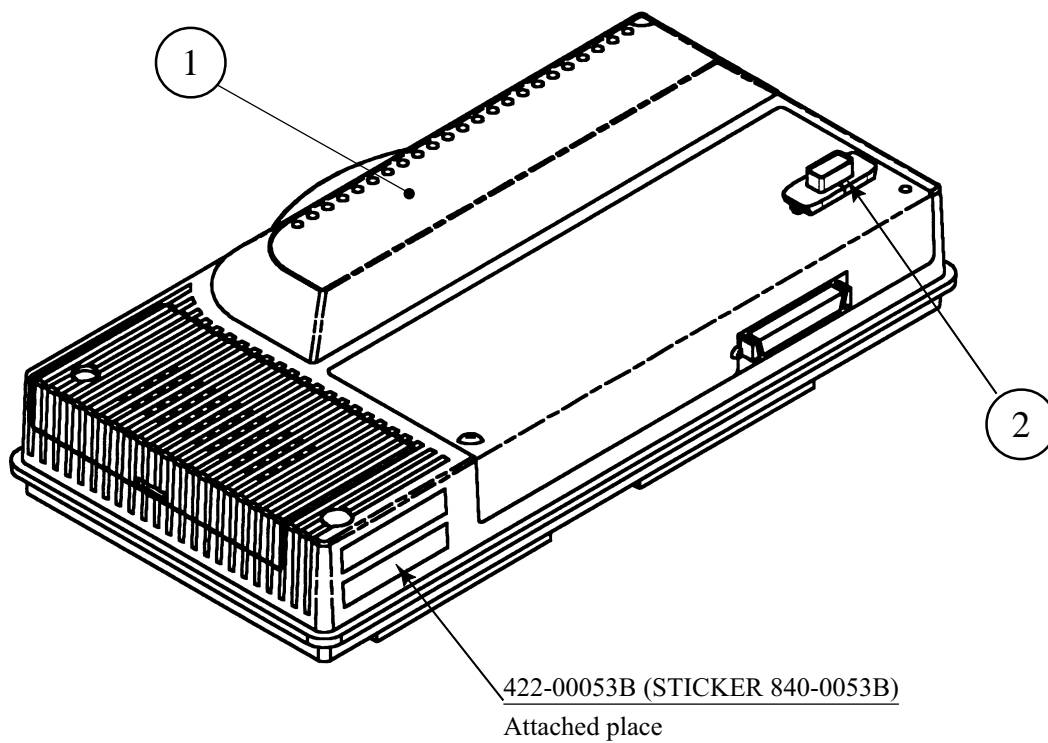

	PART NO.	DESCRIPTION
①	840-0001F	ASSY CASE NAO DIMM BD COM
②	—————	KEY CHIP
① + ②	840-0053B	DIMM BD NAO SP JAM

6. SOFT KIT



Handling the GD-ROM Disk

- Do not contaminate the disks with your fingerprints or dust particles. Contaminated disks may lower audio and video quality.
- When cleaning the disks, do not use volatile chemicals (benzine, thinner, etc.), cleaning sprays, and antistatic agents.
- Do not use cracked, warped, or damaged disks.

Do not attach papers or seals onto the disks; do not scratch the disks.

Do not use the disks with a sign of peeled seals, tapes, etc.

Observing these instructions, do not insert such a non-usable disk into the GD-ROM drive. Otherwise the inserted disk can not be ejected.

- When cleaning a heavily contaminated disk, use clean cloth that has been soaked in water and squeezed. Then remove moisture with dry cloth.
- When holding a disk, be careful not to contaminate it with your fingerprints.

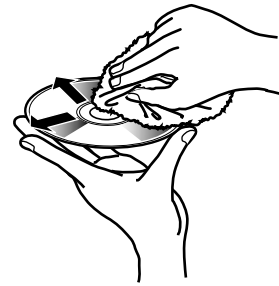

Use clean cloth to wipe the disk gently and into a radial direction.

How to Hold a Disk

With both hands:

Put your thumbs and forefingers of both hands on the disk's 4 circumference tips.

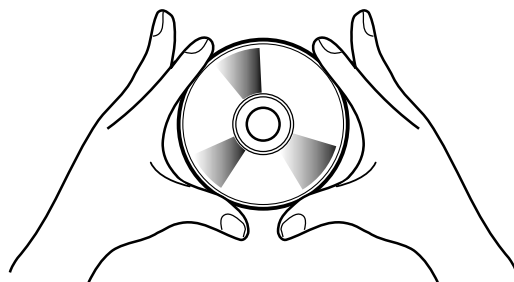

With one hand:

Insert your forefinger into a central hole and at the same time put your thumb and middle finger on the disk's 2 circumference tips.

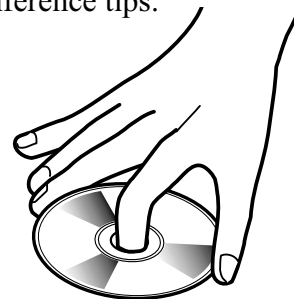

How to Handle the Key Chip

- The key chip is a precision device. Handle it carefully because it may be damaged by heat, shock, and static electricity.
- Use the key chip with the GD-ROM disk of the corresponding game that has been shipped together with the key chip.

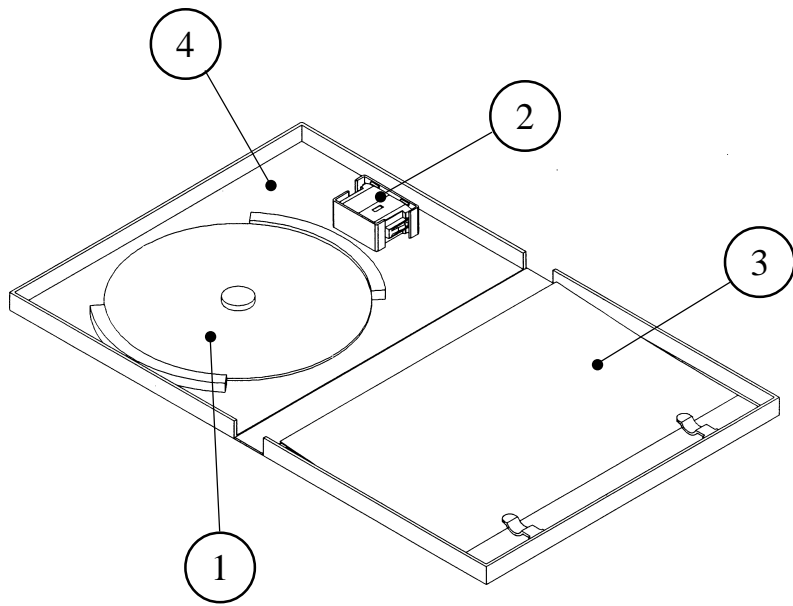

	PART NO.	DESCRIPTION
① + ② + ③ + ④	610-0630-0003	GD SOFT KIT SP JAM ENG
①	GDS-0003 *	NAOMI GDROM SP JAM
②	—————	KEY CHIP
③	420-6621-0003E	SERVICE MANUAL SP JAM ENG
④	253-5507	DISK CASE WITH IC HOLDER

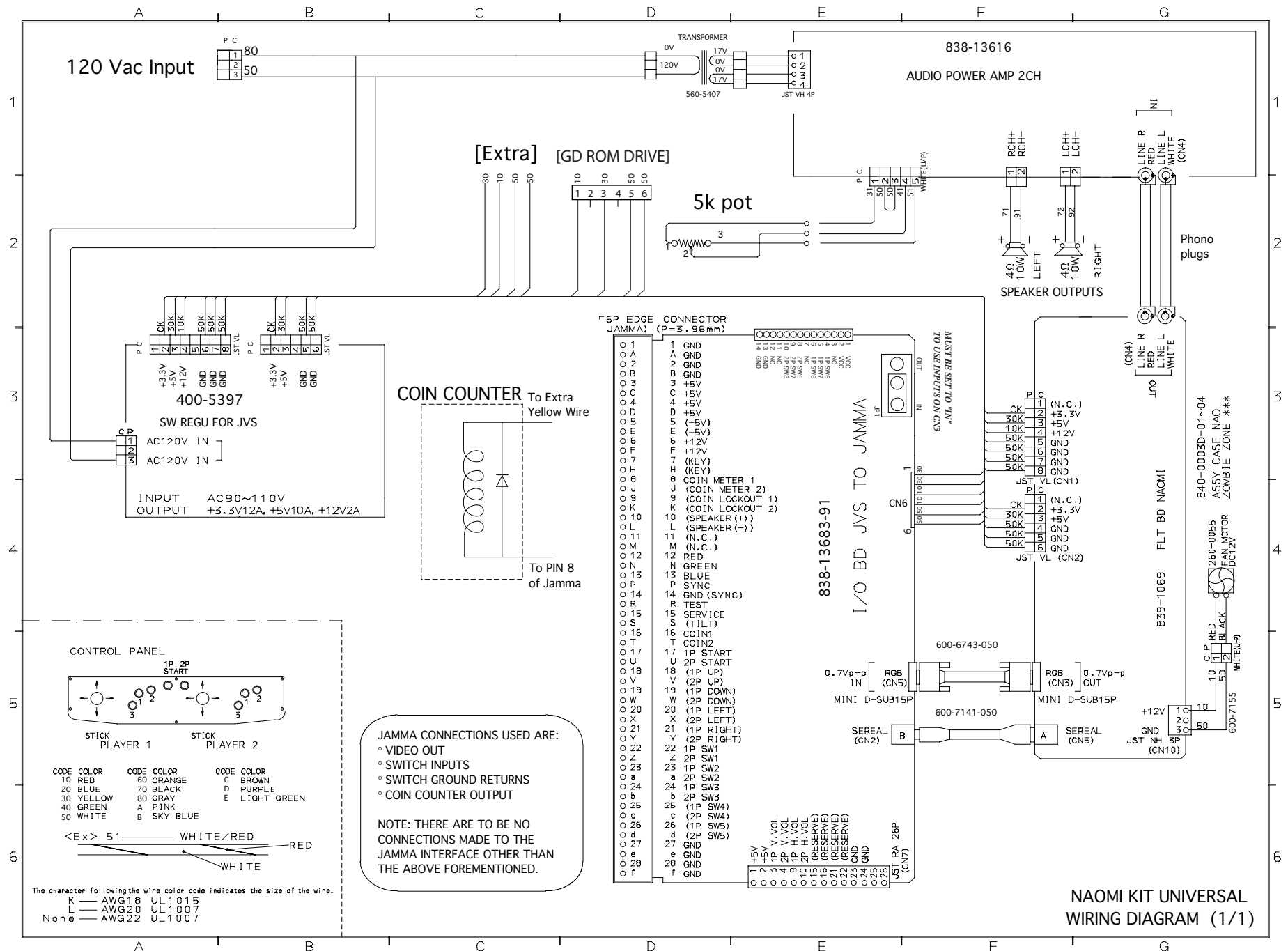

120 Vac Input



TRANSFORMER

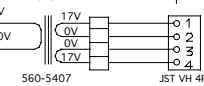

838-13616

AUDIO POWER AMP 2CH

[Extra] [GD ROM DRIVE]

5k pot

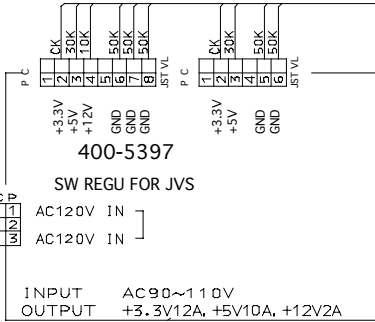

COIN COUNTER To Extra Yellow Wire

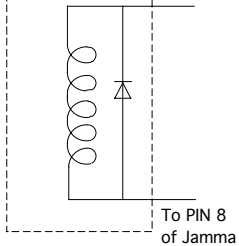

6P EDGE CONNECTOR (P=3.96mm)

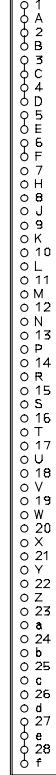

- 1 GND
- 2 GND
- 3 +5V
- 4 +5V
- 5 (-5V)
- 6 +12V
- 7 +12V
- 8 (KEY)
- 9 COIN METER 1
- 10 COIN METER 2
- 11 COIN LOCKOUT 1
- 12 COIN LOCKOUT 2
- 13 (SPEAKER (+))
- 14 (SPEAKER (-))
- 15 (N.C.)
- 16 (N.C.)
- 17 RED
- 18 GREEN
- 19 BLUE
- 20 SYNC
- 21 GND (SYNC)
- 22 TEST
- 23 SERVICE
- 24 (TILT)
- 25 COIN1
- 26 COIN2
- 27 1P START
- 28 2P START
- 29 (1P UP)
- 30 (2P UP)
- 31 (1P DOWN)
- 32 (2P DOWN)
- 33 (1P LEFT)
- 34 (2P LEFT)
- 35 (1P RIGHT)
- 36 (2P RIGHT)
- 37 1P SW1
- 38 2P SW1
- 39 1P SW2
- 40 2P SW2
- 41 1P SW3
- 42 2P SW3
- 43 1P SW4
- 44 2P SW4
- 45 (1P SW5)
- 46 (2P SW5)
- 47 GND
- 48 GND
- 49 GND
- 50 GND
- 51 GND
- 52 GND
- 53 GND
- 54 GND
- 55 GND
- 56 GND
- 57 GND
- 58 GND
- 59 GND
- 60 GND

838-13663-91

I/O BD JVS TO JAMMA

MUST BE SET TO -N/1

TO USE INPUTS ON CN6

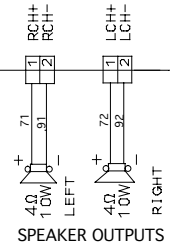

Phono plugs

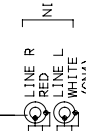

CONTROL PANEL

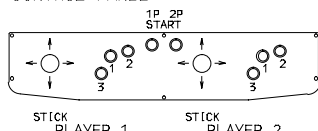

CODE	COLOR	CODE	COLOR	CODE	COLOR
10	RED	60	ORANGE	C	BROWN
20	BLUE	70	BLACK	D	PURPLE
30	YELLOW	80	GRAY	E	LIGHT GREEN
40	GREEN	A	PINK		
50	WHITE	B	SKY BLUE		

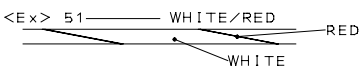

The character following the wire color code indicates the size of the wire.
 K — AWG18 UL1015
 L — AWG20 UL1007
 None — AWG22 UL1007

NAOMI KIT UNIVERSAL WIRING DIAGRAM (1/1)

VISIT OUR WEBSITE!

The screenshot shows a web browser window with the address bar set to <http://www.seuservice.com/>. The browser interface includes navigation buttons (Back, Forward, Refresh, Stop, Home, Sherlock, Preferences, Larger, Smaller, Stop) and a search bar. The website content features a large blue and white 'SEGA SERVICE' logo. To the left is a navigation menu with links such as 'what's new', 'manuals', 'bulletins', 'assy pages', 'staff', 'Darl's Office', 'corporate info', 'technical service', 'warranty Policy', 'plug-ins', 'home page', 'non-framed page', and 'seu mailing list'. Below the menu is contact information for Sega Enterprises Inc., USA, including a phone number (415.701.6580) and fax number (415.701.6594). A 'Best viewed @ 800x600' notice with a 'N' icon is also present. The main content area includes search criteria links for 'parts', 'boards', 'monitors', and 'distributors', a list of featured items ('Darl's Office', 'What's New', 'Game Manuals', 'Bulletins'), and a list of links for various site sections. A statistics box reports that 5661 people have accessed the page since June 9th. Contact information for questions is provided as darl.davidson@seu.sega.com or dave.cantrelle@seu.sega.com. The footer contains a copyright notice for Sega Enterprise Inc., USA, and a banner for 'WebSTAR 3' powered by Mac OS and Webula. A final note states: 'You will need the following items to view this page in its entirety.'

Address: <http://www.seuservice.com/>

SEGA SERVICE

Search criteria: [parts](#) • [boards](#) • [monitors](#) • [distributors](#)

SEGA SERVICE

- Darl's Office
- What's New
- Game Manuals
- Bulletins

[\[what's new\]](#)[\[manuals\]](#)[\[bulletins\]](#)[\[staff\]](#)[\[Darl's office\]](#)
[\[technical service\]](#)[\[customer service\]](#)[\[corporate info\]](#)[\[plugins\]](#)[\[Non-framed page\]](#)

A total of **5661** people have accessed this page since June 9th.

If you have any questions or comments about this Home Page please E-Mail to:
darl.davidson@seu.sega.com OR dave.cantrelle@seu.sega.com

© Sega Enterprise Inc., USA. All rights reserved.

THIS WEB SITE POWERED BY
WebSTAR 3 Mac OS Webula

You will need the following items to view this page in its entirety.



SEGA ENTERPRISES, INC. (USA)

45133 Industrial Drive
Fremont, CA 94538
(415) 701-6580 phone
(415) 701-6594 fax