

Announce

This user manual provides the user to reference only, don't provide the guarantee of any form, the user manual changes to forgive not to go another circular.

We don't do any notify if the user manual had been changed.

GAMEBOX

2004

Security Warning



For the longest use of the machine and reduce the suddenness, please for god's sake of the list below:

- The assemble inside the machine contain precise parts, conveyance and using is forbids to rough it, vibrate and collide.
- The attention keeps the machine to cooling, forbid to cover the fan. If the fan working incorrectly, please stop using it immediately, send it for checking.
- Forbid to push or pull any connect line when power on.
- Circuit board to the static electricity very sensitive, forbid to touch the electric circuit module .
- Checking if the power supply voltage is match to the region where you using it.

Catalog

Announce..... 1

Security Warning..... 2

Intro

 Functions 4

 Subassembly..... 4

Install Explain

 Before Install..... 5

 Basic compose Intro..... 5

 Quick Install manual..... 6

 Notice of Install..... 6

User manual

 Boot Machine..... 8

 Select Game 8

 Quit Game (Back to main menu) 8

 Shutdown Machine..... 8

System Setting

 System setting switch..... 9

 Function key Intro..... 13

 System setting Menu(Advance Setting)..... 13

 Game Debug Mode(Advance Setting) 17

 Machine Setting..... 21

Regulation..... 22

The difficulty answer 23

Functions

- . Include hundreds of games
- . Typical JAMMA interface
- . MultiPlayer
- . Fulling coins memory
- . 3 Seconds to mainmenu

Module contents

- Host
- Power Supply
- AC power line
- L plank
- User manual
- 20P ATX Line (accessories)
- A set of an advertisement of machine
- Game list

Before install

1. Put the host in the anti-electrostatic packing bag before install.
2. Hold the mainboard edge carefully, don't touch the accessories of the mainboard.
3. Face up the side which there are components, and put it into the box.
4. Do not distort or heavy pressure circuit board.
5. When the host working, the periphery please not to place the miscellaneous articles or objects, and please reserve space for cooling.

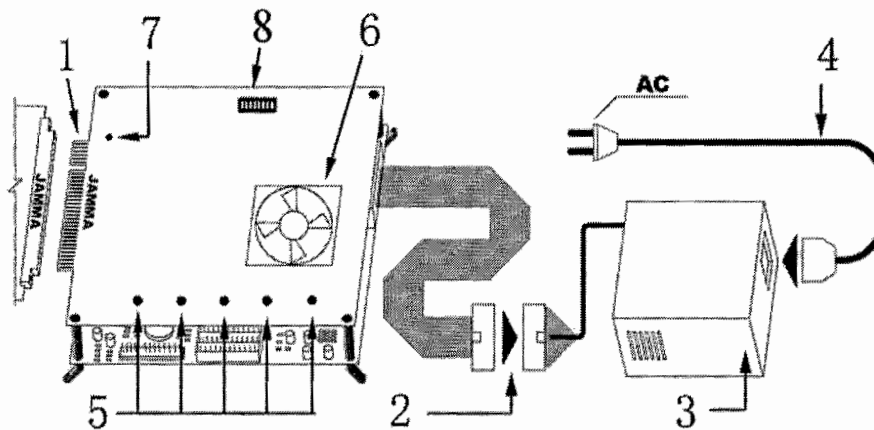
Basic compose Intro

- | | |
|------------------|----------------------------|
| 1. JAMMA 28P | 2. 20P ATX Power interface |
| 3. Power Supply | 4. AC Power line |
| 5. Function keys | 6. Cooling Fan |
| 7. Power LED | 8. System set(DIP) |

Quick Install Manual

Basic Install Sequence: (See the picture above)

1. Connect to the **20P ATX Power Interface** (you can also plug the Power 20P ATX into the Machine).
2. Plug in the **JAMMA 28P** pin.
3. Connect the AC power line in to the **power supply**..
4. Make sure the power box voltage is the same with the local region. then Power on .

Install Warning

- Notice the direction of the JAMMA 28P, do not put anti.
- When plugging the 20P ATX power, make it was align, or it should be broken. If it is plug in the machine directly, make sure it plugs ok..
- The power supply of the machine and the power box of the cabinet must be connect into the same power supply, and cut the power at the same time (see the picture below). This is very important, or the machine should not working correctly.

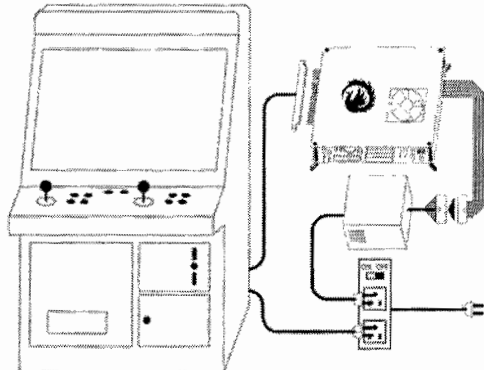

- The **B14** of JAMMA 28P(the soldering tin in) link to the same switch of the ground. The function is the same as "**Function Key K5**"(the K5's function please see page 13 "**function key intro**")

JAMMA 28P

Top (A)		Bottom (B)
GND	01	GND
GND	02	GND
+5V	03	+5V
+5V	04	+5V
	05	
+12V	06	+12V
	07	
	08	
	09	
SOUND+	10	SOUND-
	11	
Red	12	Green
Blue	13	HV
	14	Main menu (K5)
	15	
COIN (1P)	16	
START (1P)	17	START (2P)
Up (1P)	18	Up (2P)
Down (1P)	19	DoWN (2P)
Left (1P)	20	Left (2P)
Right (1P)	21	Right (2P)
SW1 (1P)	22	SW1 (2P)
SW2 (1P)	23	SW2 (2P)
SW3 (1P)	24	SW3 (2P)
SW4 (1P)	25	SW4 (2P)
SW5 (1P)	26	SW5 (2P)
SW6 (1P)	27	SW6 (2P)
GND	28	GND

Booting Machine

Boot the machine, and the screen should not synchronization. After about 20 seconds, the game menu was show (if the **system setting switch DIP-2** set to **ON**(see page 10 “**DIP-2, Game mode selection**”), the last game should run automatic. The game loading should spend some time depend on the game, there is no image on the screen when loading).

Game Select

1. Enter the main menu, use joystick to select game.
Joystick up down to select a game.
Joystick left right to select a page.
2. After coin, and press 1p' s start, it should enter the game loading, don' t coin when game loading. The loading time depend on the game.



Quit Game (Return to main menu)

- Way 1: Press K5 (see page 13 “Function key intro”)
- Way 2: Press 1P' s start for 3 seconds, (see page 11 “DIP-8 start back to menu”))
- Way 3: Press B14 (see page 7 “Install Warning”

Shutting down machine

Quit current game and back to the main menu. At last power off (make sure 2 parts of power are off).

The user could set coin,diffcult level on "System setting switch (DIP)". The Advanced user could use "System setting menu" or "Game debug mode" to set the params of each game.

We advise the normal just use "System Setting switch (DIP)" to set the params.

Notice! "Game setting menu" and "Game debug Mode" could set many system function, it could cause your machine do not working.

System setting switch (DIP)

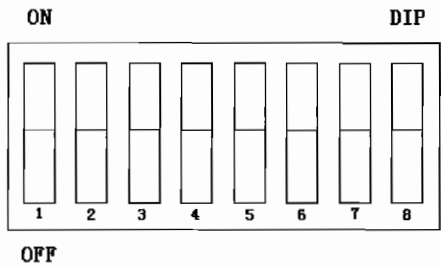

Function explain

☆ **DIP-1**

1	Function
ON	System Test (Factory Reset)
OFF	Game Mode (Factory Default)

When the machine error even could not be solving by rest, this function could check and fix system (**Factory Reset** could fix system).

Power off the machine, and set the **DIP-1** to **ON**, then boot the machine and it should go into the testing mode (see the picture below) .

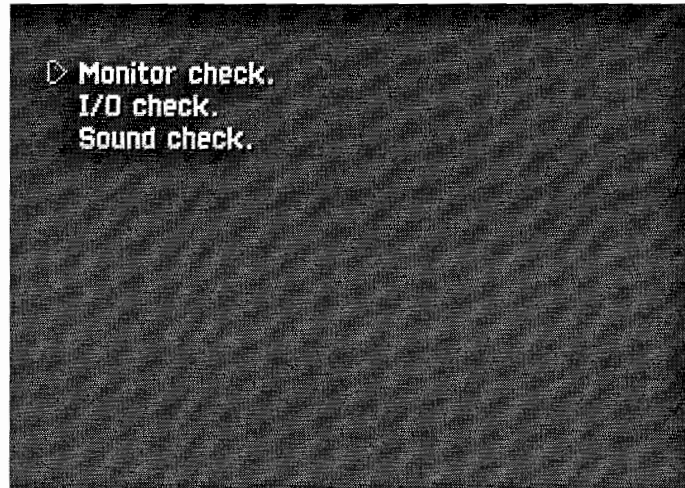

Monitor check: Test screen (Use for screen test)
I/O check: Test joystick (Use for joystick test)
Sound check: Test sound (Use for sound test)

PS: Press joystick right and press key 1 to quit I/O Check.

☆ **DIP-2, Game mode select**

2	Function
ON	Normal Arcade Mode
OFF	User Mode (Default)

Normal Arcade Mode: After boot, it loads a game automatic.

Advice to set **DIP-8** to **ON**

User Mode: After boot, Go in to the game select menu. Advice to set **DIP-8** to **ON**.

☆ DIP-3, DIP-4, Game level setting

3	4	Game Level
ON	ON	Very Hard
ON	OFF	Hard
OFF	ON	Normal
OFF	OFF	Easy (Default)

★ DIP-5, Control Function Key (K1 ~ K4)

5	Function
ON	K1 ~ K4 Enabled
OFF	K1 ~ K4Diasble (Default)

★ DIP-6, DIP-7, Coin Setting

6	7	Function
ON	ON	1 Coin 1 Credit (Default)
OFF	OFF	
OFF	ON	2 Coin 1 Credit
ON	OFF	1 Coin 2 Credit

★ DIP-8, Start Key back to menu

8	Function
ON	Diasble
OFF	Enabled (Default)

The machine either to use **K5** back to main menu, or press **1P start** 3 seconds to back to main menu too. **DIP-8** to enabled the function. When **ON**, the function disable.

PS. ☆ Need reboot to function.

★ Don' t need.

Setting Example (Only the function which need to reboot)

1. Shutdown machine.
2. Set **DIP-1** to **DIP -8**.
3. Boot Machine.
4. Appear a picture (see below), up side is old, down side is new.

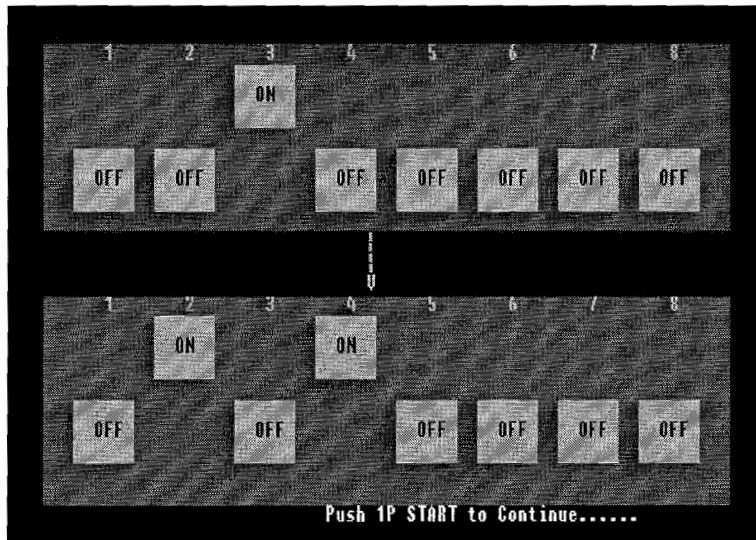

5. Make use which DIP is you need, and press 1P START to confirm。 Then the main menu appear, the setting is OK.

Notice: The DIP setting is used to all games.

Function key intro

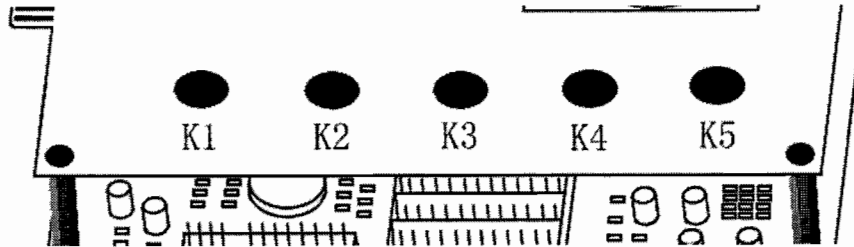

K1 Confirm system setting

K2 System setting

K3 Game Debug Mode

K4 Reset game

K5 Back to main menu

System setting menu

Basic Function:

1. When the game running, press **K2** to run the system setting menu.
2. Use joystick to select the **DIP Switches**, press **K1** to enter.
3. Use joystick the select the function.
4. Press **K5** for back to last menu level, and back to game.
5. Press **K4** to reset game.

We make “64th Street” as a example, other game is similar..

Press **K2** to enter system menu.

System setting menu

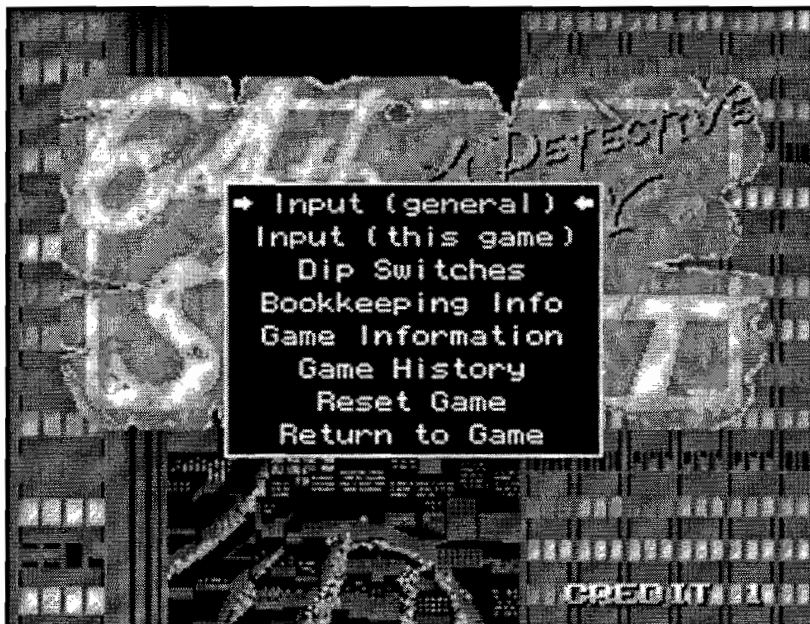

Input (general)

Input (this game)

Dip Switches

Bookkeeping Info

Game Information

Game History

Reset Game

Return to Game

Dip Switches

Move to “Dip Switches”, press K1.

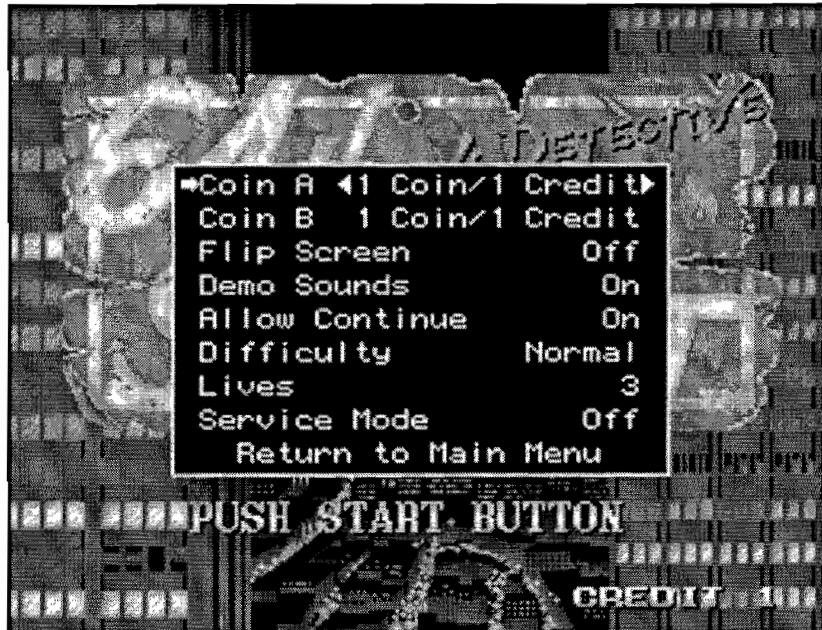
Dip Switches

Coin A

Coin B

(X) Coin/(X) Credit is coin N to play N time. Such as 1 Coin/1 Credit, 2 Coin/1 Credit, 1Coin/2 Credit.

Flip screen

On off (Factory setting)

Demo Sounds

On (Factory setting) off

Allow Continue

On (Factory setting) off

Difficulty

Easy

Normal (Factory setting)

Hard

Hardest

Lives

factory setting 3 Lives.

Service Mode

On off (Factory setting)

Return to Game

Select this to back to game

Notice: Only quitting game to save setting. Don' t power off before quit game.

Game debug mode

There is no “Dip Switches” in some game, so you can use Game debug Mode.

Active Game Debug Mode

Way 1, If there is “Dip Switches” in menu.

1. Set “Service Mode” to ON.
2. Press K4 to reset game.

Way 2, If there is no “Dip Switches” in menu.

Press K3, and 2 mode should be appear:

- a. Nothing appear, pres K4 reset.
- b. Into Service mode.

Quit Debug Mode

Way 1, Set “Service Mode” Of “Dip Switches” to OFF, press K4.

Way 2, Press K3 (only once), then press K4.

Notice: Using debug mode must be according to the screen.

We use game “**Alien VS Perdator**” to show how the debug mode use.

Basic process: Up down to select item, press 1p’s fire to set, press 1P and 2P’sstart to back to previous menu, .



There is "Dip Switches".

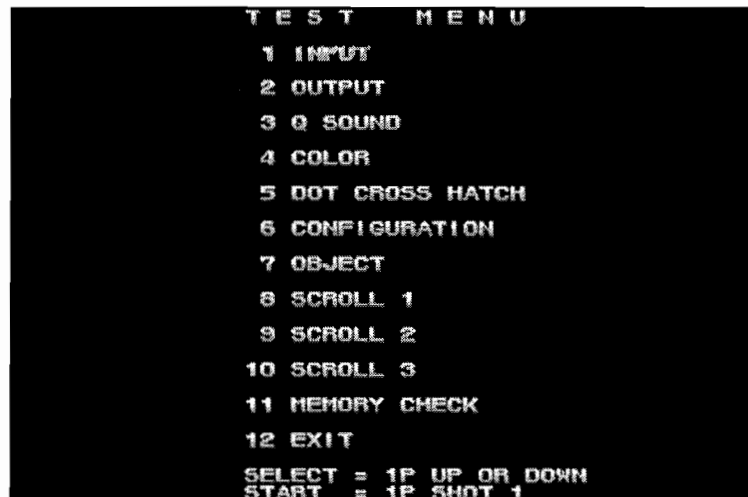

Select CONFIGURATION

CONFIGURATION (配置)



SYSTEM

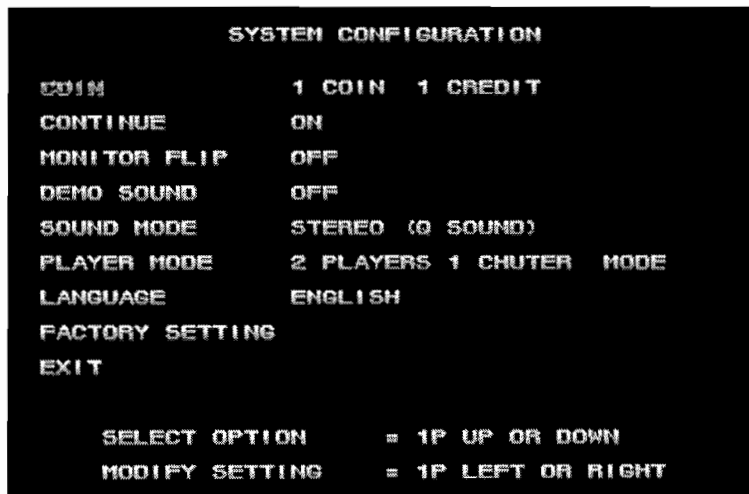

COIN
CONTINUE
MONITOR FLIP

DEMO SOUND
PLAYER MODE
LANGUAGE
FACTORY SETTING
EXIT

GAME



DIFFICULTY
FACTORY SETTING
EXIT

Notice:

1. The setting does not save before "EXIT"
2. Maybe some game could not be set.

Reset to default

Set “System setting DIP” DIP-1 to ON, then press K5, see the picture below, then press Start to Reset.

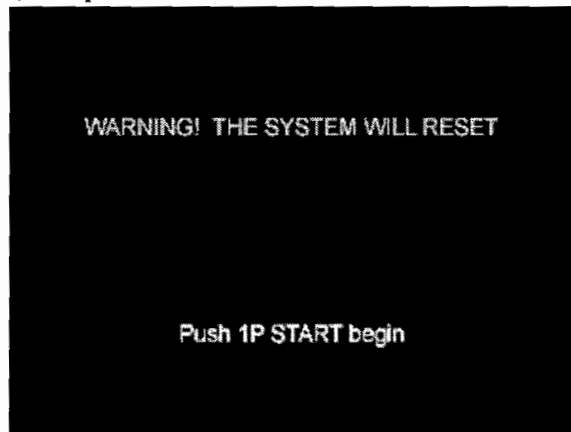

Then wait until the picture below. Shutdown and set the **DIP-1** to **OFF** and but again.



1. Please read the instruction before your install.
2. Don't store it in the wet and dust environments; difference in temperature will be easy to breakage.
3. Please set it on solid ground.
4. Please turn off the power before your move it.
5. Please make sure the power is off before you take out any signal wire.
6. After choice the programs don't press the K5 key before the loading is finished. If error press IP "start" button or Power key reboot.
7. Don't press any button until your see the menu when you turn on the power.
8. If the fan does not work correctly, turn off the power at once and send it to the fix center.
9. If any error could not be solving, please contact the retainer.

Warning again:

The 2 power supply must be set in the same source, power of and power off must be the same time.

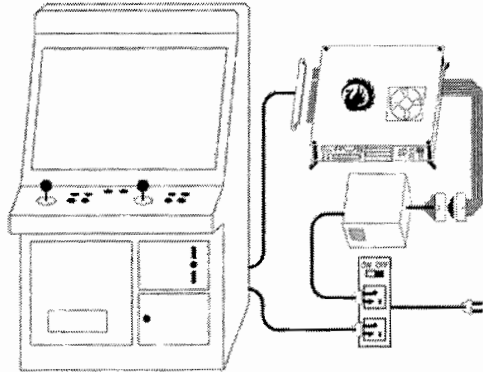

Q1: Not any responding after boot

A: Is the fan work?

If it not work, is the power ok? Check the power line.

If it works, shutdown and wait for minutes and boot again.

Q2: The image is not synchronization.

A: Is the power LED work?

Not work: Is the power ok? Check the power line.

Work: Check the signal line, and the **JAMMA 28P** Pin.

Q3: After booting, it runs the game directly, and I want the game menu.

A: check if **DIP—2** on? Check **DIP—2**. (See page 10 “**System setting DIP**”)

Q4: No sound.

A: In the menu, there is no sound.

In the game, make sure you had turn on the sound. Check the volume.

Q5: Hang.

A: Is the voltage tranquilization, try reboot.

B: Is the fan work? Check the fan.

Not work: Check if the fan crash by something.

Work: If the problem appears frequency, check the **HARD DISK**.

Q6: Every time I run some game it go to the setting mode.

A: Check if the game set to the debug mode. (See page 17, “**Game debug mode**”-“Quit debug mode”)

Q7: There is a red image in the menu.

A: That was reading error. It cause by when a game was reading the press the ESC key. Reboot or press 1P's start should work.

Q8: Why I pressing the 1P's start button, but it can quit to the menu?

A: How long you had pressed? You must press more than 3 seconds.

B: Check if the **DIP-8** was **ON** (see page 10, "**DIP-8, Start button quit to menu**")

Q9: Oh my god! I set all the thing in mix!

A: Set the DIP-1 On, it should restore factory setting. (See page 9, "system seating dip)

Q10: I want to check if all keys are functioning.

A: You should use "**system test**". Set **DIP-1** to **ON**, and reboot the machine then you can test. (See page 9, **system setting switch**)

Note: If you meet other problem not above on the list, please contact the dealer directly. Or go to <http://www.gamebox.cc> for more information.