



MAY 1997
16-34014-101

MACE



The Dark Age

TM

UNIVERSAL KIT

OPERATION MANUAL

Operation & Adjustments • Testing & Problem Diagnosis
Parts Assembly & Installation • Wiring Diagrams

WARNINGS & NOTICES

WARNING

USE OF NON-ATARI PARTS OR CIRCUIT MODIFICATIONS MAY CAUSE SERIOUS INJURY OR EQUIPMENT DAMAGE! USE ONLY ATARI AUTHORIZED PARTS.

* For safety and reliability, substitute parts and modifications are not recommended.

* Substitute parts or modifications may void FCC type acceptance.

* Use only authorized components and parts. Failure to do so will void warranty and may result in incorrect and/or unsafe operation.

* This game is protected by federal copyright, trademark and patent laws. Unauthorized modifications may be illegal under federal law. This also applies to ATARI logos, designs, publications and assemblies. Moreover, facsimiles of ATARI equipment (or any feature thereof) may be illegal under federal law, regardless of whether or not such facsimiles are manufactured with ATARI components.

MACE™ KIT

SECTION
ONE

INSTALLATION

Warning

USE OF NON-ATARI PARTS OR CIRCUIT MODIFICATIONS MAY CAUSE SERIOUS INJURY OR EQUIPMENT DAMAGE! USE ONLY ATARI AUTHORIZED PARTS.

* For safety and reliability, substitute parts and modifications are not recommended.

* Substitute parts or modifications may void FCC type acceptance.

SAFETY NOTICES

The following safety instructions apply to all operators and service personnel. Specific warnings and cautions will be found throughout this manual where they apply. We recommend that you read this page before preparing your game for play.

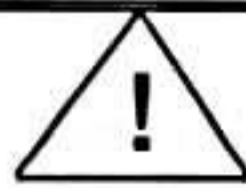

CAUTION

HANDLING ELECTRONIC DEVICES: Observe the following precautions for handling electronic devices.

- 1) Ensure that the A.C. power to the game is turned off prior to servicing the electronics.
- 2) Discharge any static electricity build up in your body by touching a safety ground point such as the power supply chassis. This must be done **BEFORE** touching or handling the electronic assemblies.
- 3) Store the electronic assemblies in an anti-static area. Anti-static bags must be used to store the CPU board assembly. Use the same bag to save the old CPU assembly after the new unit is installed.
- 4) **DO NOT** remove or connect any electronic assemblies when the cabinet power is on. Doing so will damage the electronic assemblies and void the warranty.

DISCONNECT POWER DURING INSTALLATION OR REPAIRS. Always turn your game OFF and unplug it before attempting to service or install your kit. Installing or repairing PC boards with power ON can damage components and void the warranty. Be sure that all ground wires are installed securely.

PROPERLY GROUND THE GAME. To avoid electrical shocks, do not plug in the game until it has been inspected and properly grounded. This game should only be plugged into a grounded 3-wire outlet. Do not use a "cheater" plug or cut off the ground pin on the line cord.

USE PROPER FUSE. To avoid electrical shock, all replacement fuses must match the original fuse in fuse type, voltage rating, and current rating.

SALVAGED PARTS. Parts salvaged from old games are required to complete your kit. These salvaged parts must operate perfectly; otherwise, the converted game cannot perform properly or safely. Always repair circuit board malfunctions and cabinet damage before conversion is attempted.

POWER SUPPLY. Be sure the power supply from your old game is capable of +5Vdc at 5A, -5Vdc at 1A, and +12Vdc at 3A. All power supply voltages are $\pm 5\%$ under load. These operating voltages are necessary for the kit. Your power supply must be FCC approved.

WIRING. This kit uses as much of the existing wiring as possible. To avoid errors in operation, verify that the wiring is an exact match with the diagrams after the conversion is completed.

SPEAKERS. This kit is intended for stereo full range speaker systems handling at least 25 WATTS.

MONITOR. This kit is not intended for use with X-Y monitors. Suitable monitors have horizontally mounted CRTs and raster electronics with inputs for RGB video and COMPOSITE NEGATIVE SYNC.

COIN MECHANISMS. Be sure to clean and test your game coin mechanisms with known currency. Servicing of these mechanisms is crucial to your game's earning potential and operation.

COIN METERS. Coin meters are not provided with this kit. Wiring information is provided as a convenience to the operator. Existing meters may be used provided their operation is verified.

HANDLE FLUORESCENT TUBE AND CRT WITH CARE. If you drop a fluorescent tube or a CRT and it breaks, it will implode! Shattered glass can fly eight feet or more from the implosion.

HARD DISK DRIVE. The hard disk drive must be packed in an anti-static bag. The disk drive assembly must be removed from the tray and packed in an approved shipping container (P/N 08-8068) in order to be sent in for repair or replacement. Do not stack or drop hard disk drives during installation or removal.

PRODUCT SPECIFICATIONS

Player Variables

1 or 2 players per game
High Score Recognition

Operator Variables

Coinage, Game Options,
Difficulty, Volume, Audits,
Statistics

Diagnostics

Automatic Power-Up Self-Test
Manual Multi-Level Menu System

CABINET SAFETY REQUIREMENTS

For safe use of this game, install this kit into a standard Atari Games Corporation "family" cabinet, or into any universal game cabinet that is listed by Underwriters Laboratories.

NOTICE - FCC COMPLIANCE

INSTALLATION OF THIS KIT INTO ANY EXISTING PRODUCT DOES NOT GUARANTEE COMPLIANCE WITH FCC REQUIREMENTS. YOU ARE SOLELY RESPONSIBLE FOR FCC COMPLIANCE FOR INSTALLATIONS IN OTHER PRODUCTS. ANY EXISTING FCC COMPLIANCE STICKER MUST BE REMOVED AND A NEW STICKER SHOULD NOT BE INSTALLED ON THE CONVERTED PRODUCT UNTIL YOU HAVE VERIFIED FCC COMPLIANCE.

EPILEPSY WARNING

A very small portion of the population has a condition which may cause them to experience epileptic seizures or have momentary loss of consciousness when viewing certain kinds of flashing lights or patterns that are present in our daily environment. These persons may experience seizures while watching some kinds of television pictures or playing certain video games. People who have not had any previous seizures may nonetheless have an undetected epileptic condition.

If you or anyone in your family has experienced symptoms linked to an epileptic condition (e.g. seizures or loss of awareness), immediately consult your physician before using any video games.

We recommend that parents observe their children while they play video games. If you or your child experience the following symptoms: dizziness, altered vision, eye or muscle twitching, involuntary movements, loss of awareness, disorientation, or convulsions, DISCONTINUE USE IMMEDIATELY and consult your physician.

ATTENTION

PROPERLY ATTACH ALL CONNECTORS. Be sure that the connectors on each printed circuit board (PCB) are properly connected. If they do not slip on easily, do not force them. A reversed connector may damage your game and void the warranty. All connectors are keyed to fit specific pins on each board.

INSPECTION

Unpack the materials from the carton and inspect for obvious signs of damage. Use this checklist to be sure the kit is complete. You must supply the remainder of the materials required for this conversion.

Part Number	Item	Quantity	Function
[] A-21068	Fan Assembly	1	(cooling for electronics and disk drive)
[] A-21464	CPU Board Assembly	1	(CPU Board Assembly [shipped on tray])
[] A-21682	Hard Disk Drive Assembly	1	(game program and graphic images)
[] A-21686	Electronics Tray Assembly	1	(mounting tray for game electronics)
[] 03-9532	Fan Bracket with Integral Grille	1	(mounts fan assembly, protects blades)
[] 03-9378	Fan Grille with Mounting Barbs	1	(protects fan blades from fingers, wires)
[] 03-9388-10	Plastic Push Rivet	4	(to attach fan grille to fan assembly)
[] 03-9663	Attraction Shield	1	(clear plastic cover for marquee)
[] 03-9664	Control Panel Cover	1	(to protect control panel surface)
[] 08-8067	Universal 25" Monitor Bezel	1	(to cover monitor mounting brackets)
[] 16-8587-825	FBI Warning Label	1	(federal game protection warning)
[] 16-9922.1	Epilepsy Warning Label	1	(alerts players to epilepsy possibility)
[] 16-10139	FCC / Canada Warning Label	1	(suggestions to avoid interference)
[] 16-10406	Control Panel Template	1	(to mark new player control hole layout)
[] 16-34014-101	Mace Kit Manual	1	(installation, operation, troubleshooting)
[] 20-9620	T-20 Tamper Resistant Wrench	1	(for installing tamper resistant screws)
[] 20-10209-1	Long Shaft Pushbutton (Red)	5	(player 1 character activity controls)
[] 20-10209-3	Long Shaft Pushbutton (Blue)	5	(player 2 character activity controls)
[] 20-10385-6	8 Way Joystick (Black)	2	(player 1 and 2 position controls)
[] 20-10383	Hard Disk Drive Power Cable	1	(supplies disk drive operating voltages)
[] 31-2642-2	Marquee artwork	1	(identifies game cabinet to players)
[] 31-2643.1	Bezel Top Decal	1	(game rules and player moves)
[] 31-2644.1	Bezel Bottom Decal	1	(game rules and player moves)
[] 31-2648	Control Panel Side Decal	2	(to cover existing cabinet markings)
[] 31-2649	Control Panel Wallpaper Decal	1	(to cover existing panel markings)
[] 31-2650	Control Panel Markings Decal	1	(to identify player controls)
[] 4006-01005-04	6-32 x .25" Machine Screw	4	(to attach disk drive to electronics tray)
[] 4108-01193-10B	#8 x .625" Tamper Resistant Screw	10	(to mount clear cover onto control panel)
[] 4308-01123-24B	8-32 Carriage Bolt (Black)	8	(to attach joysticks to control panel)
[] 4408-01119-00	8-32 KEPS Hex Nut	8	(to attach joysticks to control panel)
[] 4700-00012-00	.375" Flat Washer	8	(to attach joysticks to control panel)
[] 4700-00129-00	.468" Flat Washer (Black)	8	(to attach joysticks to control panel)
[] 5556-13956-00	2 Piece 1.25" Square Ferrite Bead	2	(controls radio frequency interference)
[] 5556-13957-00	2 Piece .75" Square Ferrite Bead	1	(controls radio frequency interference)
[] 5795-15286-00	Hard Disk Drive Data Cable	1	(connects disk drive [shipped on tray])

Recommended tools and supplies

[] black semi-gloss paint	[] black electrical tape
[] electric drill and wood drill bit set	[] small screw assortment
[] screwdrivers	[] razor knife
[] liquid soap (dishwashing detergent)	[] squeegee or soft sponge
[] grease pencil or marker	[] soldering iron and solder
[] nut drivers or socket wrench set	[] wire cutters
[] 180 grit sandpaper or electric sander	[] pliers
[] wood filler material (putty, glue, board, etc.)	[] hole saw or equivalent

KIT PACKAGING

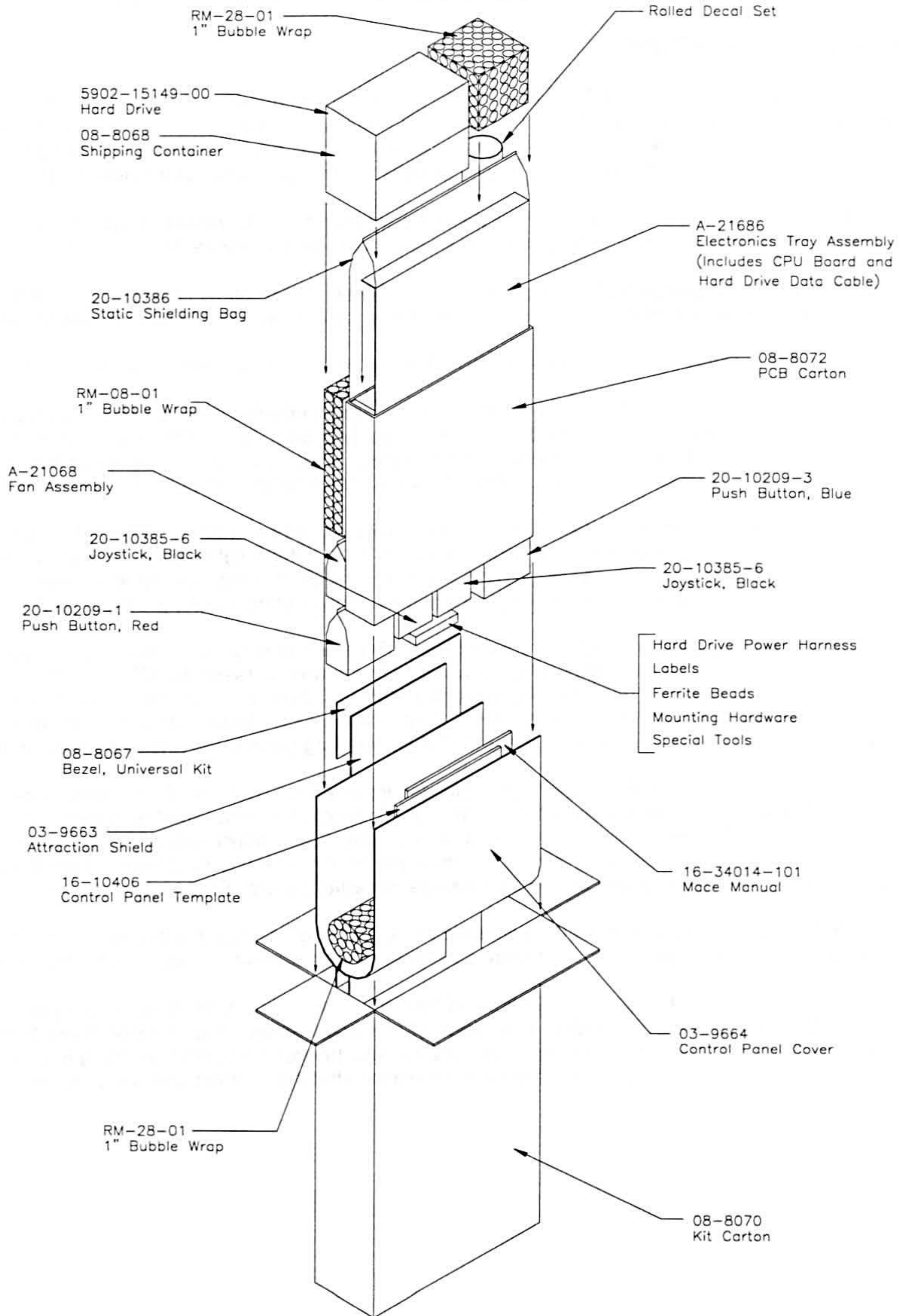

CONVERTING A TYPICAL VIDEO GAME CABINET

CABINET MODIFICATIONS

1. Verify the operation of the existing game before making any changes to the cabinet. Pay special attention to those components that will be used again after conversion is completed (Power Supply, Video Monitor, Currency Acceptors, Wiring Harnesses, Cabinet Locks, Speakers, Fluorescent Lamp, Cooling Fans, Mounting Brackets, etc.). Repair or replace damaged parts before installing the kit.
2. Switch off power to the game. Disconnect the line cord from the A.C. power. Clear the work area. Cover or protect the non-wood items (marquee, monitor, coin door, brackets, line cord, etc.).
3. For cabinets with decorated sides, remove decals or artwork. Clean off all glue residue. Fill gouges, unused holes, etc with quick-hardening wood putty. Sand the cabinet smooth and remove all dust.
4. Evenly cover the entire cabinet with black paint. Allow the paint to dry completely before continuing.
5. Pencil a line roughly at the top of the previous graphic. Lightly moisten the cabinet with soapy water. Remove the backing and apply the decal. Start at the top and work down. After the decal is in place, smooth it outwards, taking care to squeeze out air bubbles. If you can not remove an air bubble, pop it with a knife or pin and smooth it down. Allow at least 12 hours for the adhesive in the decal to set.
6. Remove the existing attraction shield and marquee from the game cabinet. Check the lamp and install a new one if cracks or darkened ends are found, even if it still lights at the time of inspection. Install the new kit marquee. Using the previous shield as a guide, trim the new attraction shield to size and deburr the edges. Clean the new marquee attraction shield before installing it in the game.
7. Remove the viewing glass and set it in a safe place. Remove the original monitor bezel. Clean the CRT glass. Trim the new monitor bezel as required to fill the area between the CRT and the cabinet. Apply the player moves and the game play instruction decals to the top and bottom of the new monitor bezel. Place the Epilepsy Warning label on the front of the monitor bezel. Be sure that decals and labels do not obstruct the viewing area. Clean bezel and viewing glass before installing in the game.
8. If this kit is installed in a 25" ATARI universal family video cabinet, the FCC compliance label (16-10139) supplied may be placed on the rear of the cabinet after other existing labels have been removed. The FCC label must not be placed on the converted product until all ferrite beads have been installed exactly as instructed and compliance has been verified by FCC tests. ***Installation of this kit into any other product does not guarantee compliance with FCC requirements.***
9. Remove and save the screws at the top and sides of the rear door. Unlock the rear door, then lift it off of the cabinet and set it aside. Use a vacuum cleaner to remove any dirt or debris inside the cabinet.
10. Locate the control panel latches or fasteners and free the control panel from its operating position. If there is no wiring harness connector, label each of the wires before disconnecting them from the Player Controls. Once the wires are disconnected, remove the control panel from the game cabinet. Save the mounting brackets and hardware for reinstallation after the control panel has been modified.

CONTROL PANEL MODIFICATIONS

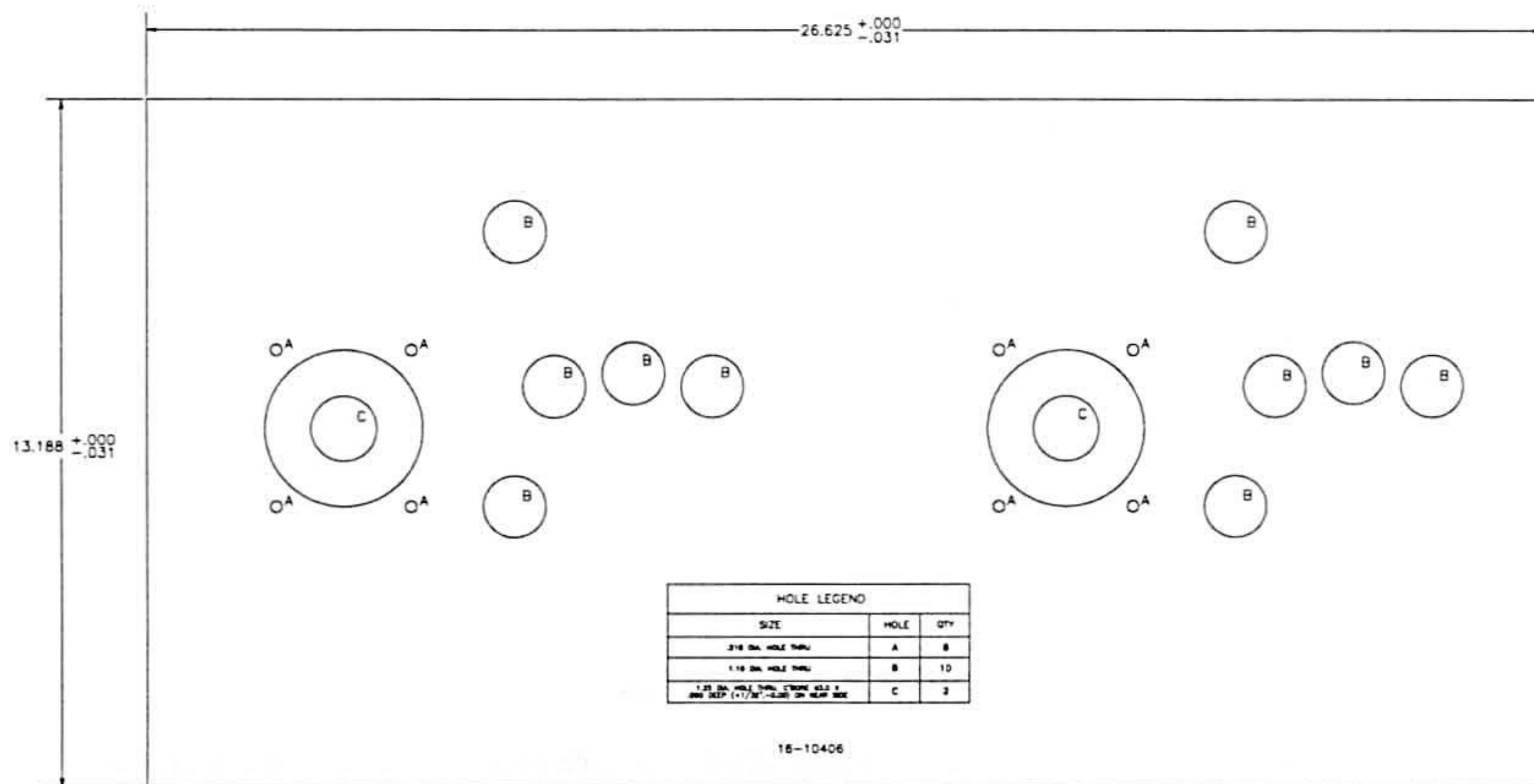

CONTROL PANEL TEMPLATE

1. Locate the control panel template (16-10406) and unfold it. Stack newspapers, books, magazines, etc., on the template until needed. This will flatten it sufficiently for use.
2. Remove the control panel buttons and joysticks from the existing control panel. Remove the panel covering and any artwork from the previous game. Remove any hinges or mounting brackets.
3. Fill the existing control panel holes with wood, putty, glue or other suitable material. Allow adequate time for materials to dry, then sand or file the control panel to a flat surface on both sides.
4. Place the template on top of the repaired panel. Orient it to center the controls and tape it in place. Cut and deburr all holes for the joysticks and the control panel buttons. Remove the template.
5. Place the control panel face down on top of the clear plastic cover and center it. Mark the outside shape of the panel and the hole locations onto the cover. Remove the control panel and set it aside. Cut and deburr all holes for the joysticks and control panel buttons. Trim the cover to panel shape.
6. Remove the backing and apply the decal to the panel. Start at the top and work down. After the decal is in place, smooth it outwards, taking care to squeeze out air bubbles. If you can not remove an air bubble, pop it with a knife or pin and smooth it down. Allow the adhesive in the decal to set.
7. Use a sharp knife to trim the edges and to cut the holes for the control panel buttons and joysticks. Position the control decals next to the appropriate hole locations.
8. Install the plastic cover over the decals and the panel. Attach the cover and deburr the edges.
9. Group the Player Controls by color: Player 1 pushbuttons are blue. Player 2 pushbuttons are red. The controls must be disassembled for panel mounting. Install one player control group at a time.
10. Separate a switch from its push-button. Bend the large prong away from the switch just enough to slide the switch off of the housing. Unscrew the nut from the housing. Insert the push-button housing through a switch hole from the front side of the control panel. Screw the nut finger tight onto the switch housing from the back of the panel. Snap the switch back onto the housing.

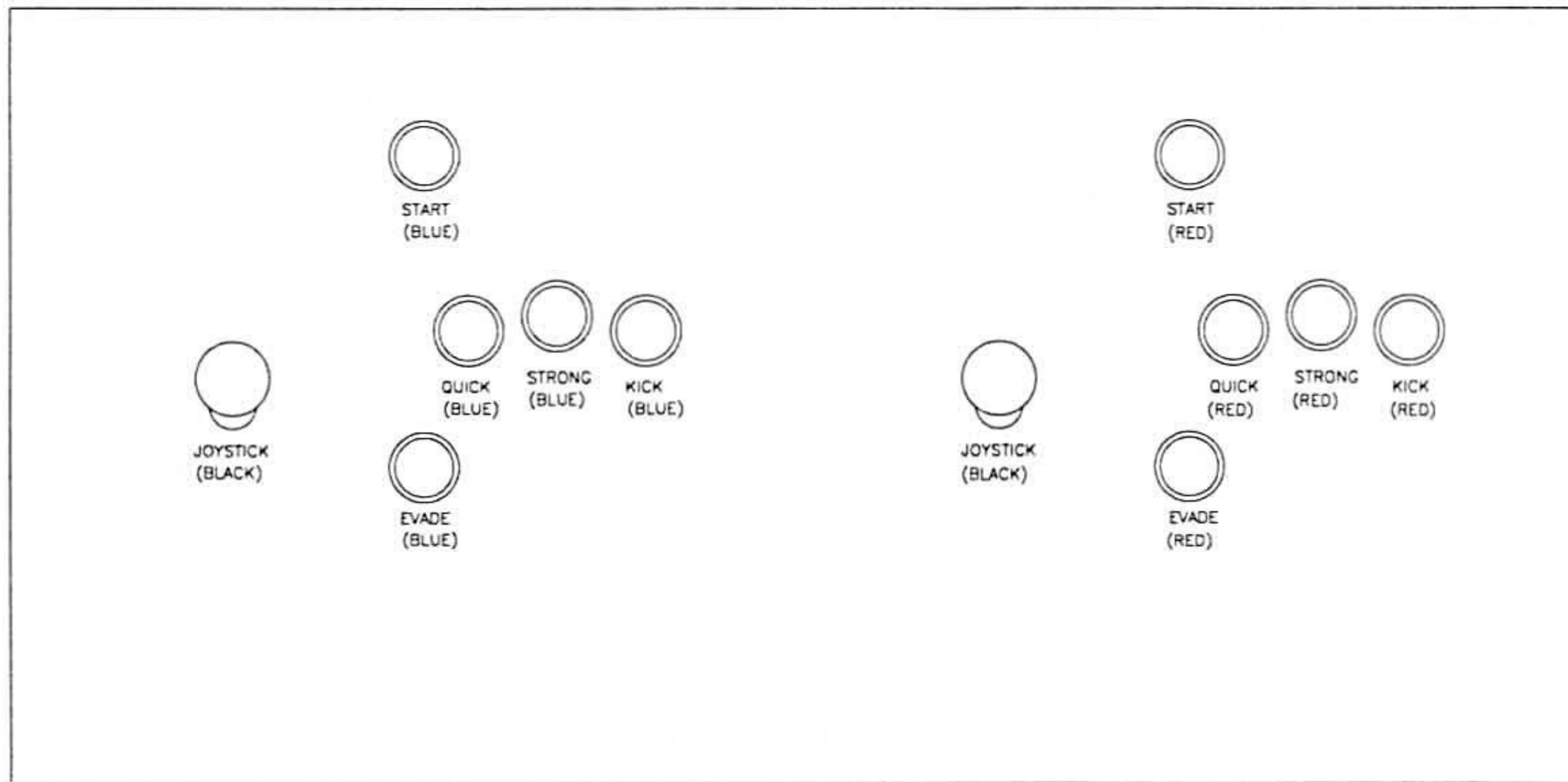

CONTROL LOCATIONS

11. Repeat this step for each button of the same color. Continue until all button groups are mounted.
12. Disassemble a joystick for mounting. Invert the joystick and remove the "E"-ring from the shaft. Remove the handle and the plastic ring (large washer) from the joystick base. *Be sure that the bushings remain in the base.* Place the top of the joystick base against the bottom of the control panel and align the mounting holes. Attach the base to the underside of the control panel with carriage bolts, washers, and nuts. Slide the plastic ring around the shaft so that the rough side is next to the shaft knob handle. Slide the shaft through the control panel and base. Replace the "E"-ring.
13. Repeat this step for the other joystick. Check each control for freedom of movement in all directions.
14. Rotate the buttons so that the switch terminals are properly oriented and tighten the nuts firmly.
15. The completed control panel should now resemble the illustration below. Install the modified control panel onto the modified cabinet using the existing mounting hardware.

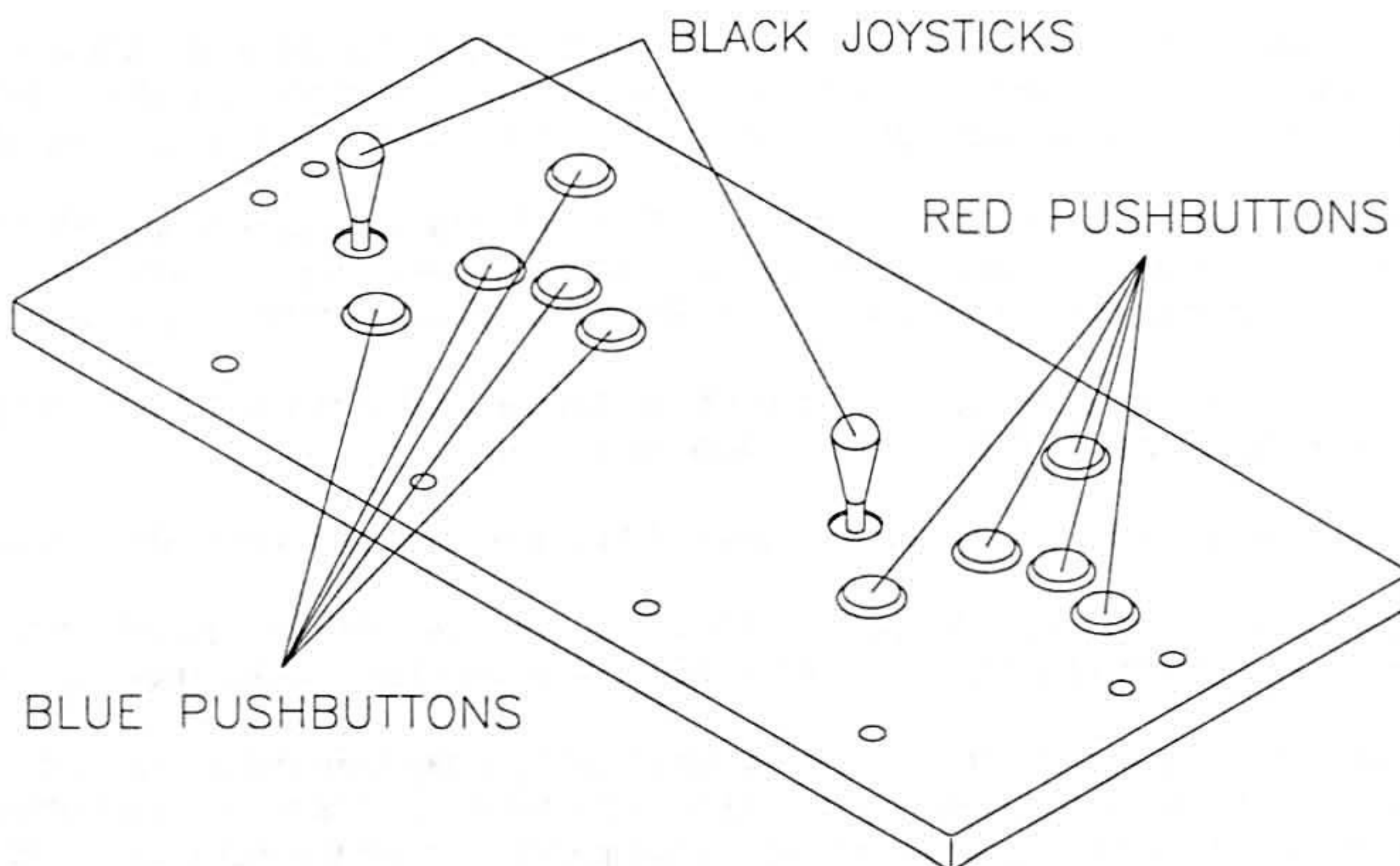

TYPICAL COMPLETED CONTROL PANEL

GAME ELECTRONICS TRAY COMPONENTS

The CPU Board Assembly electronic components are static sensitive. Prepare an anti-static work area and ground yourself before removing the CPU Board from its protective shipping materials.

Do not connect any cable to the CPU Board Assembly or Power Supply with the power turned on. Doing so while the power is turned on may damage the game and void your warranty.

CAUTION: HARD DISK DRIVES ARE FRAGILE. Do not stack or drop Hard Disk Drive Assemblies.

1. Be certain that the power is switched off and the cord is disconnected from the A.C. line voltage. Carefully disconnect the cables on each printed circuit board in the game. Remove the existing printed circuit board set and the disk drive (if present) and set aside. Anti-static bags and protective containers from the new components may be used to store these items after conversion is complete.
2. Remove the Electronics Tray Assembly from its packaging and place it on a flat work surface. Locate the Hard Disk Drive Power Cable (separate wires with four-pin nylon connectors at each end). Attach the power cable to CPU power connector P4 (near the large heatsinks). Mate the connectors and press firmly to seat the contacts fully. *The connector is keyed. Do not use excessive force.*
3. Remove the Hard Disk Drive Assembly from its package. Locate the data and power connectors on the Hard Disk Drive. Orient the Disk Drive with connectors toward the CPU Board and place it into the mounting brackets on the tray. Align the screw holes and install mounting screws and lockwashers.
4. Connect the remaining end of the Hard Disk Drive Power Cable to the connector on the disk drive. Mate the connectors and press firmly to seat the contacts fully. *Do not use excessive force.*
5. Locate the free end of the Hard Disk Drive Data Cable (flat ribbon with stripe on one side). This cable is already attached to the CPU Board Hard Disk Drive Connectors. Orient this cable with the striped edge closest to the power cable. Attach the cable to the drive data connector. Mate the connectors and press firmly to seat the contacts fully. *This connector is keyed. Do not use excessive force.*

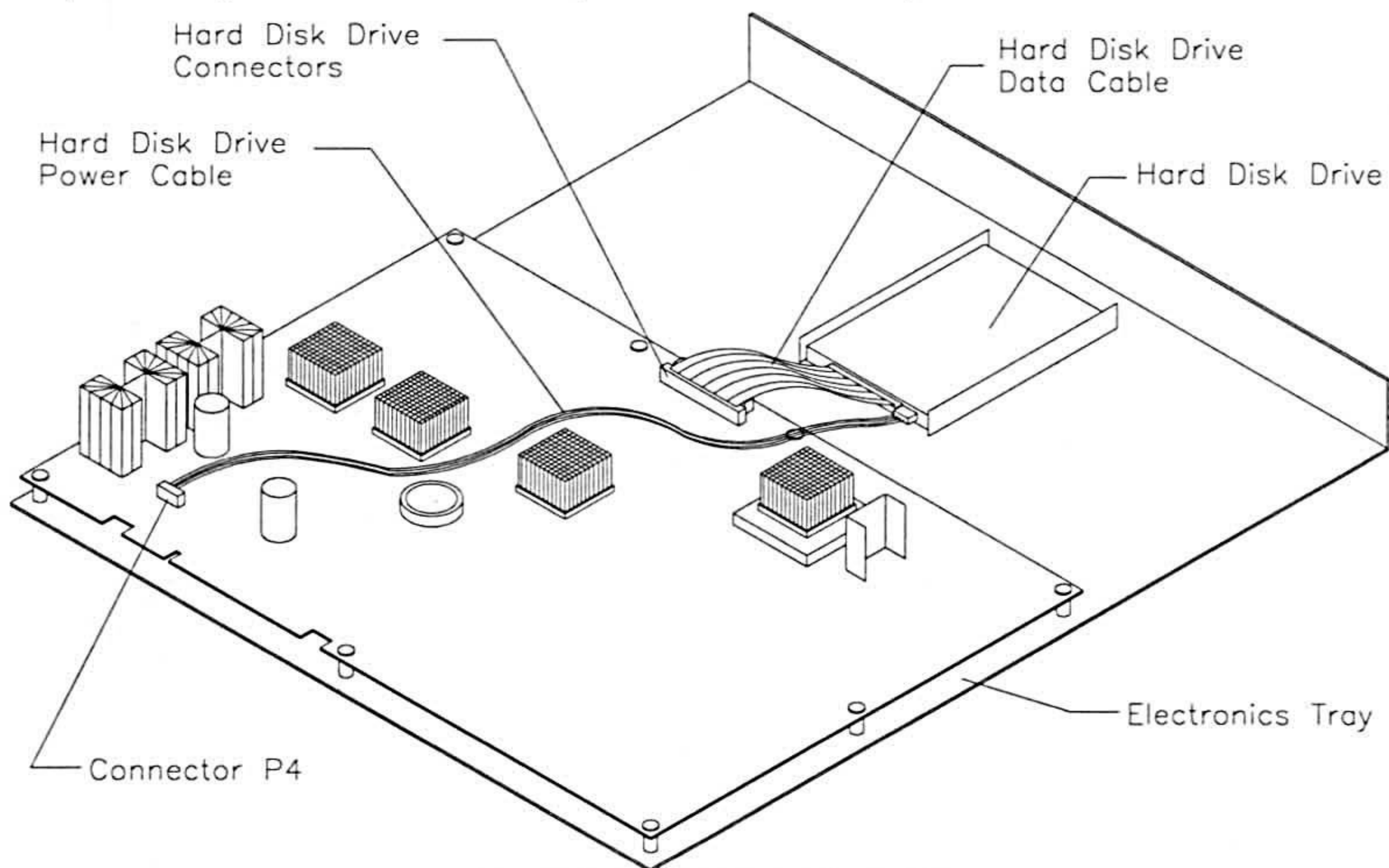

MOUNTING COMPONENTS ON ELECTRONICS TRAY

FAN ASSEMBLY

1. Locate the fan and its associated parts. Orient the fan so that air movement will be toward the grille and away from the bracket (look for markings on the fan to indicate air flow direction).
2. Align the fan grille with the front side of the fan as illustrated. Insert the grille barbs into the fan holes and press firmly to seat the grille fully.
3. Align the fan bracket with the back side of the fan. Insert one push rivet through the bracket hole and into the fan hole. Repeat this process for the remaining rivets. Press firmly to seat the bracket fully.
4. Insert one locking pin into each rivet and press firmly to seat the rivet fully.
5. Locate a source of power for the fan (refer to Wiring Diagram in Section Three for assistance). Place the completed fan in the game and connect the wiring. *Do not mount the fan at this time.*

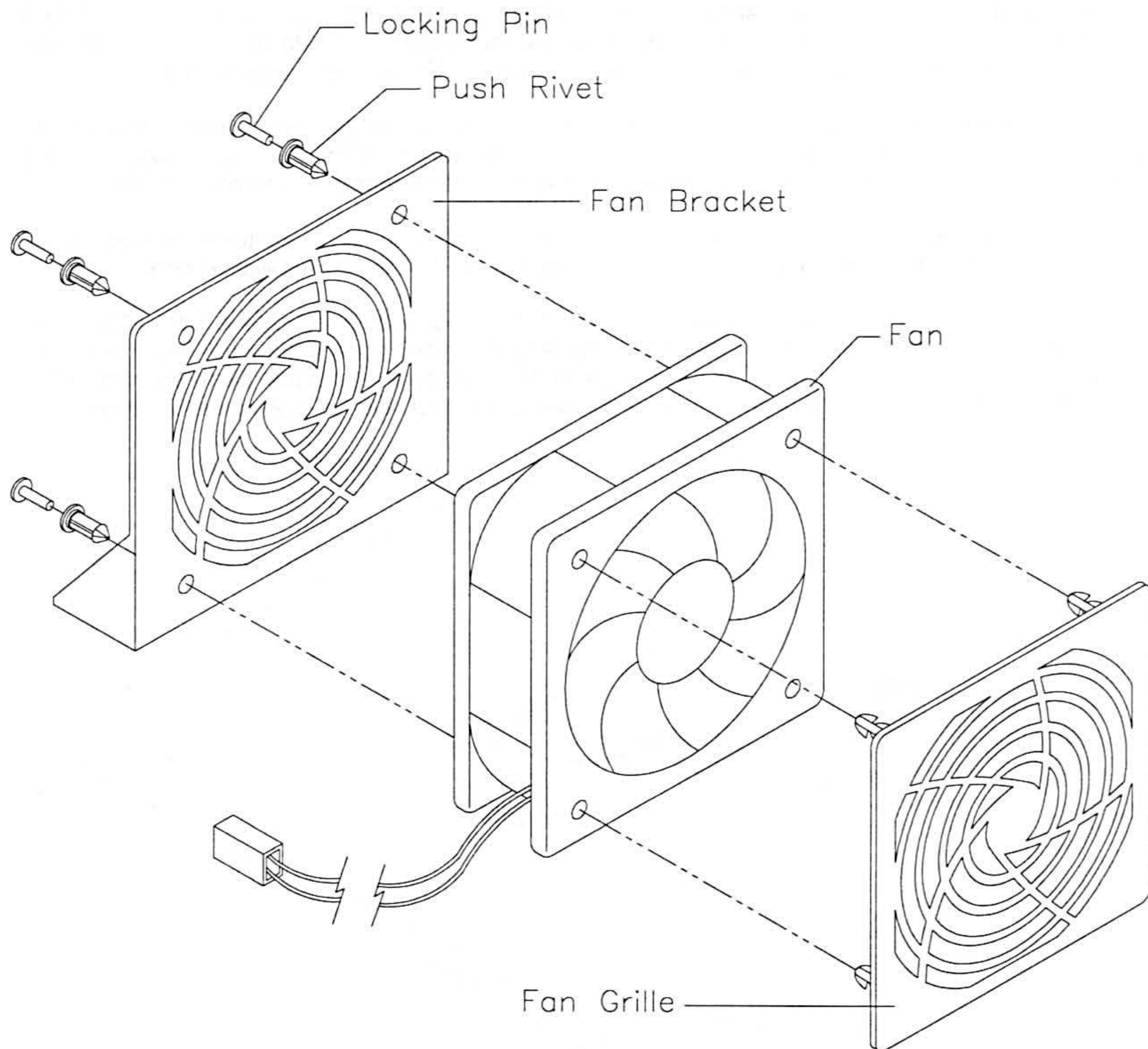

ASSEMBLING FAN COMPONENTS

FINAL ASSEMBLY

1. Place the completed Electronics Tray in the cabinet where the previous electronics were located. Locate the JAMMA edge connector on the CPU Board (near two largest heatsinks and the inductors). Orient the tray so that the JAMMA contact area on the CPU board is next to the JAMMA connector on the harness. The disk drive must be as close to the cabinet floor as possible if the tray must be vertical (i.e., wall mounting). Ensure that there will be adequate space nearby for the cooling fan if there is one already in the cabinet. Use the tray itself as a template to mark mounting hole locations.
2. Locate a sufficient quantity of mounting screws (not supplied with the kit). If necessary, drill pilot holes for screws. Install a screw in every mounting hole and secure the Electronics Tray to the cabinet.
3. Adjust fan position as needed to direct air over CPU heatsinks as illustrated. Install screws as before.
4. Electrical codes require conductive assemblies to be grounded for safe product operation. Locate the central power ground point for the cabinet (ground wires are usually green; some may have a yellow stripe). Connect a short, heavy gauge ground wire from the tray to the central power ground.
5. Locate the square split ferrite beads. Separate the wires in the main harness into two bundles where they attach to the JAMMA connector. Install one large ferrite bead around the D.C. power conductors (solid color heavy gauge wires with pin numbers 1-6 or A-F). Install the other large bead around the control panel conductors (striped color lighter gauge wires). Install the small ferrite bead around the signal wires (monitor, speakers, coin door, etc.). Place the beads as close to the JAMMA connector as possible, then close and lock each one. Ensure that no wires are pinched or caught in the latches.
6. Attach the JAMMA Connector to the CPU Board. Mate the connectors and press firmly to seat fully. *The connector is keyed. Do not use excessive force.* Fold unused wiring back away from the board.

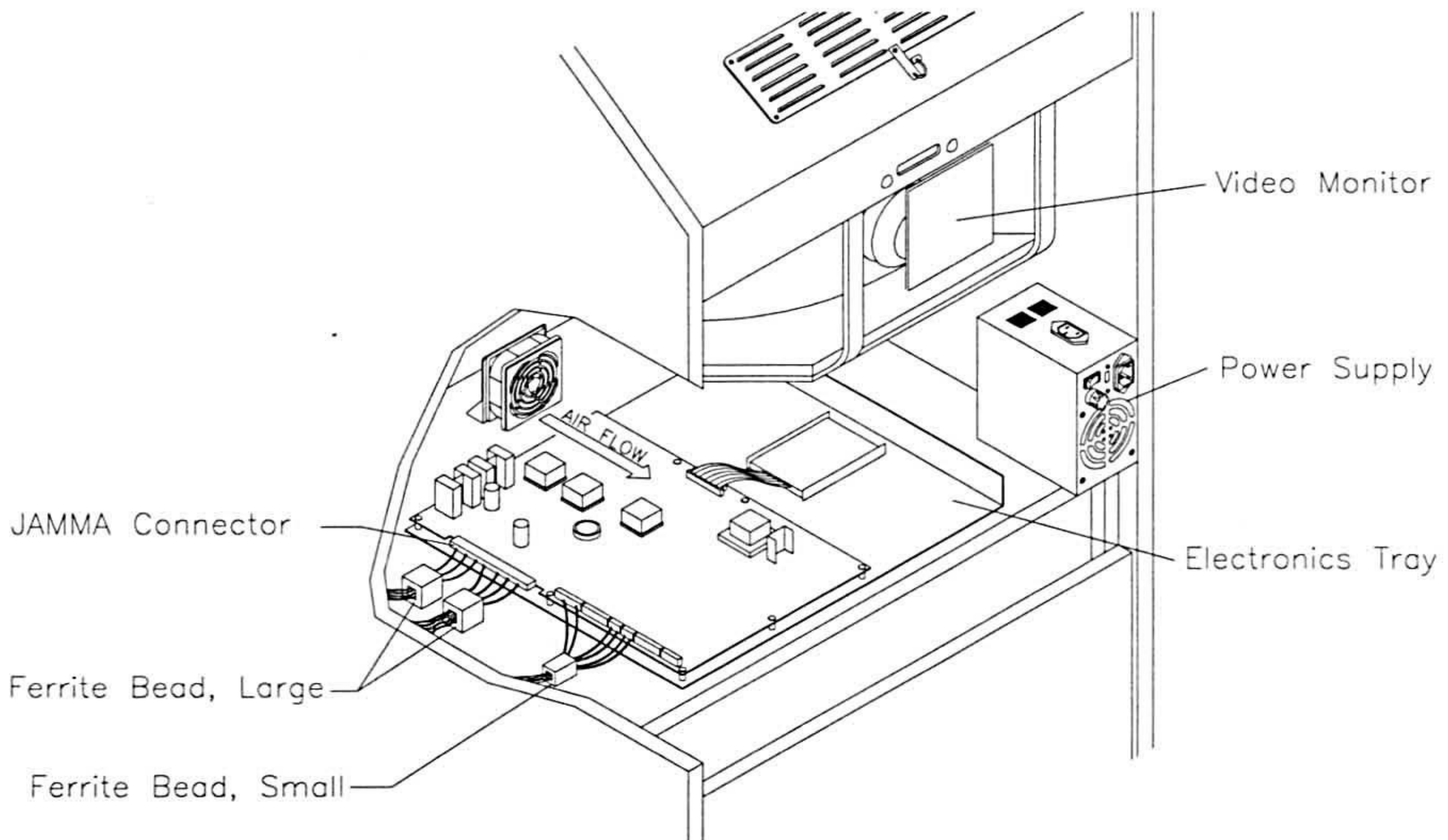

TYPICAL CPU BOARD AND HARD DISK DRIVE ORIENTATION

INITIAL POWER UP

1. Plug the line cord into a source of A.C. power and turn it on. CPU Board indicators should illuminate.
2. The game will load the program and begin self diagnostics. If no errors are found, the game will automatically enter its "attract" mode. Check wiring and refer to Troubleshooting (Section Four) if problems occur.
3. Unlock and open the coin door. Press and hold the TEST button until the menu system appears on the screen. Select CONTROLS TEST and verify that each switch and control operates properly. Use other tests to verify speakers, monitor, disk drive, etc. Refer to Operation (Section Two) for test steps.
4. Close and lock the coin door. Replace the rear cabinet door. Allow the system to operate for several hours before attempting any game changes. Refer to Operation (Section Two) for adjustment steps.
5. When proper operation is confirmed, the game may be tested for FCC or other agency approval.

YOU ARE SOLELY RESPONSIBLE, AND ATARI WILL HAVE NO RESPONSIBILITY FOR FCC COMPLIANCE FOR INSTALLATIONS IN PRODUCTS OTHER THAN A 25" ATARI UNIVERSAL FAMILY VIDEO CABINET). THE FCC COMPLIANCE STICKER SUPPLIED MUST NOT BE INSTALLED ON THE CONVERTED PRODUCT UNTIL FCC COMPLIANCE IS VERIFIED.

MACETM

THE DARK AGE

SECTION TWO

OPERATION

NOTICE

Information in this manual is subject to change without notice. ATARI reserves the right to make improvements in equipment function, design, or components as progress in engineering or manufacturing methods may warrant.

Fill out and mail in the Game Registration card. Be sure to include the game serial number from the label on the rear of the cabinet. For your records, write the game serial number in the manual. SERIAL NUMBER _____

SAFETY NOTICES

The following safety instructions apply to all game operators and service personnel. Specific warnings and cautions will be found throughout this manual where they apply. We recommend that you read this page before preparing your game for play.



CAUTION

HARD DISK DRIVE. The hard disk drive must be packed in an anti-static bag. The disk drive assembly must be packed in an approved shipping container (P/N 08-8068) in order to be sent in for repair or replacement. Do not stack or drop hard disk drives during installation or removal.

TRANSPORTING GAME: This game contains glass and fragile electronic devices. Transport this game securely. Avoid rough handling. Do not move this game with power on.

AC POWER CONNECTION. Verify that the switch on the power supply is set for 110VAC or 220VAC according to local line voltage. Verify that the fluorescent lamp assembly is correct for local line voltage.

PROPERLY GROUND THE GAME. To avoid electrical shocks, do not plug in the game until it has been inspected and properly grounded. This game should only be plugged into a grounded 3-wire outlet. Do not use a "cheater" plug or cut off the ground pin on the line cord.

POTENTIAL SHOCK HAZARD. This video game system does not utilize an isolation transformer. No isolation exists between the internal cabinet AC system and the external AC line.

DISCONNECT POWER DURING REPAIRS. To avoid electrical shock, turn off the power switch and disconnect the game from the AC power source before removing or repairing any part of the game. After servicing any parts of the unit, be sure that all of the ground wires are secure before restoring power.

USE PROPER FUSE. To avoid electrical shock, all replacement fuses must match the original fuse in fuse type, voltage rating, and current rating.

PROPERLY ATTACH ALL CONNECTORS. Be sure that the connectors on each printed circuit board (PCB) are properly connected. If they do not slip on easily, do not force them. A reversed connector may damage your game and void the warranty. Connectors are keyed to fit specific pins on each board.

HANDLE FLUORESCENT TUBE AND CRT WITH CARE. If you drop a fluorescent tube or CRT and it breaks, it will implode! Shattered glass can fly eight feet or more from the implosion.

EPILEPSY WARNING

A very small portion of the population has a condition which may cause them to experience epileptic seizures or have momentary loss of consciousness when viewing certain kinds of flashing lights or patterns that are present in our daily environment. These persons may experience seizures while watching some kinds of television pictures or playing certain video games. People who have not had any previous seizures may nonetheless have an undetected epileptic condition.

If you or anyone in your family has experienced symptoms linked to an epileptic condition (e.g., seizures or loss of awareness), immediately consult your physician before using any video games.

We recommend that parents observe their children while they play video games. If you or your child experience the following symptoms: dizziness, altered vision, eye or muscle twitching, involuntary movements, loss of awareness, disorientation, or convulsions, DISCONTINUE USE IMMEDIATELY and consult your physician.

GAME OPERATION

STARTING UP

Each time the game is first turned on or power is restored, it begins executing code out of the boot ROM. These self-diagnostic tests automatically verify and report condition of the hardware and the disk drive. The screen is blank during these tests. If any of the individual tests fails, then an error message will be displayed for each test. The message will be displayed for 30 seconds or until any button is pressed.

- * If no buttons are pressed, the system will quickly complete all tests then load and run the game.
- * Press and hold the coin door TEST button to skip the boot ROM tests and activate the Menu System.

Once all Power-up tests have been passed, the game goes into its "attract mode". Scenes and sounds from a typical game are alternated with previous high scores in an endless pattern until game play starts.

Insert currency to start the game. Play begins after a character has been chosen. The game will progress until time is exhausted. If no more play is required, the game automatically returns to the "attract mode".

GAME RULES *Play instructions are found on the monitor bezel just above and below the video screen.*

INDIVIDUAL PLAY

Insert currency to start the game. Choose one player control group and press the nearest START button. Select a character and begin your search for victims.

MULTIPLE PLAYERS

Insert currency to start the game. Choose player controls and press the START buttons. Select your characters.

PLAYER CONTROLS (NOTE: Use joystick and button combinations to discover secret moves.)

The player controls are used to maneuver the characters and attack or defend against adversaries.

◆ **START Button**

This button allows players to begin or continue play.

This same button is used to select items from the menus during service.

◆ **QUICK Button**

The QUICK button speeds up an action. The joystick affects which direction the action takes place.

This same button is used to return from the menus during service.

◆ **STRONG Button**

The STRONG button permits an extra burst of power. The joystick directs this extra power.

This button has no dedicated function during service.

◆ **KICK Button**

The KICK button activates the legs. The joystick affects which direction the character will kick.

This button has no dedicated function during service.

◆ **EVADE Button**

The EVADE button allows the character to escape. The joystick affects the direction of escape.

This button has no dedicated function during service.

◆ **JOYSTICKS**

Each player has a joystick to control the movements of an on-screen character.

The joystick is also used to select items from the menus and make changes during service.

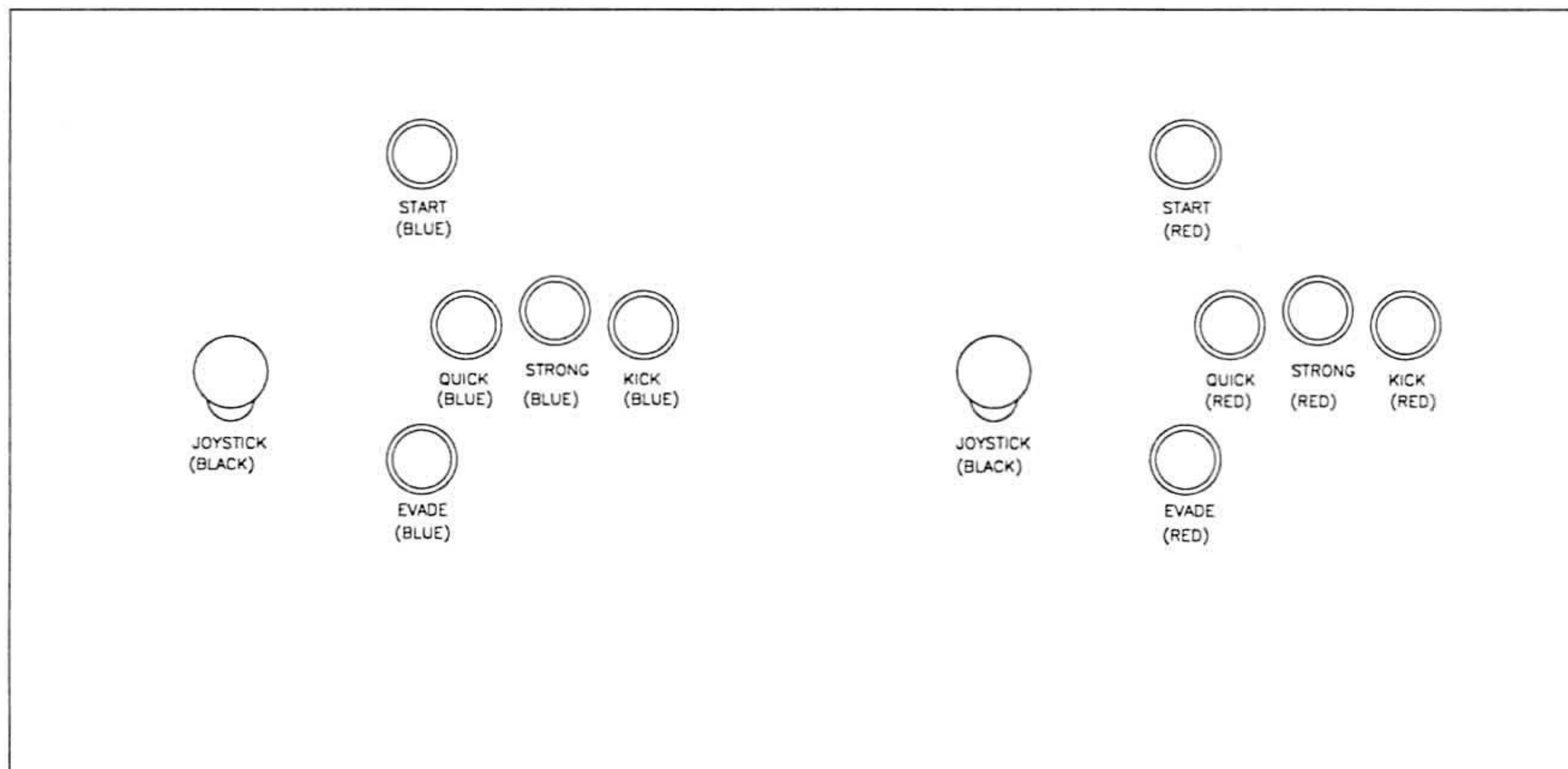

CONTROL LOCATIONS

OPERATOR CONTROLS

Access to the menu system for statistics, adjustments, or testing is secured by lock and key to prevent tampering. When the menu system is entered, on screen messages guide the operator through tasks.

CABINET SWITCHES

◆ Power Switch

The **Power Switch** turns off the game during service. It does not reset the game variables.

◆ Slam Tilt Switch

The **Slam Tilt** switch prevents game abuses such as pounding to obtain free games.

◆ Monitor Remote Adjustments (inside the cabinet under the monitor)

The **Monitor Remote Adjustment Board** sets the video display for optimum viewing.

CONTROL SWITCHES

◆ Volume Down and Volume Up Buttons

The **Volume Down** and **Volume Up** push-button switches increase or decrease game sound levels. Press either button briefly to make minor changes. Press and hold a button to make major changes. Volume may also be changed with the joysticks and buttons when the menu system is active.

NOTE

For greater profits, adjust your volume levels to a loud setting to draw attention to this game.

◆ Begin Test Button

The **Begin Test** push-button switch enters the menu system. Press the Begin Test button briefly to run the automatic tests. Press and hold the Test button to get to any of the menu selections.

◆ Service Credit Button

The **Service Credit** push-button switch allots credits without changing the game's bookkeeping total.

NOTE

The coin door must be open to reach the control switches.

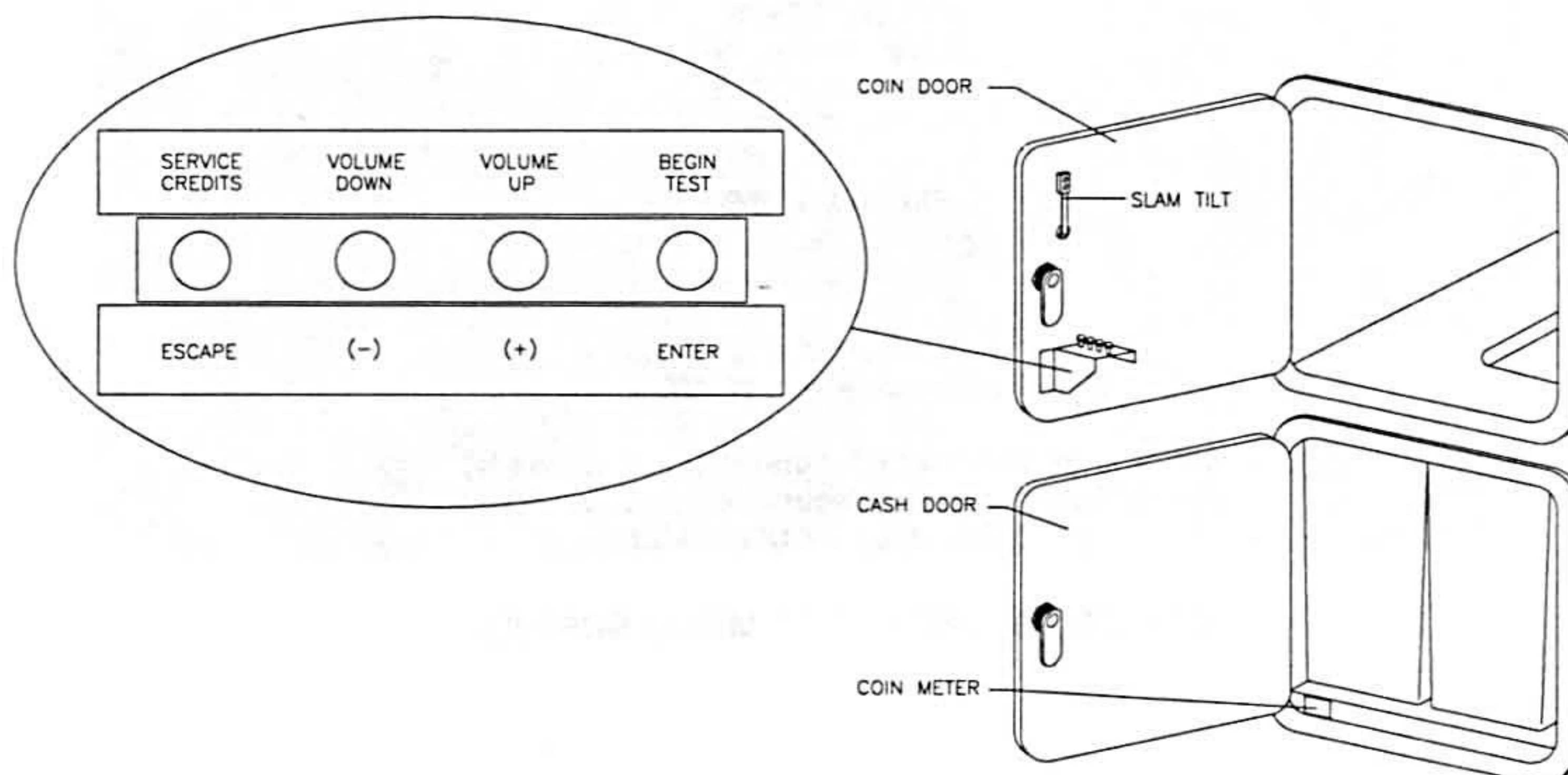

TYPICAL CONTROL SWITCH LOCATIONS

MENU SYSTEM

SYSTEM OVERVIEW

Game variables and diagnostics are presented in a series of on-screen menus. The Main Menu screen allows the operator to view information, make changes, or verify equipment operation. Each Sub Menu screen displays one specific group of choices. The Detail Menu presents data or runs the required test. You must be at the Detail Menu level to detect errors, make changes, or activate tests. Both the operator controls and the player controls are used to move through the menus and start or stop particular routines.

SCREEN LAYOUT

Each menu screen is different, but the material presented stays in the same physical location each time.

The color bar at the top center of each screen displays the current menu title.

The center of the screen is used for data (menu items, video signals, statistics, reports, etc.)

The bottom of the screen is reserved for messages (control functions, revision levels, etc.)

ORGANIZATION

Main Menu screen items fall into two categories: options and tests. Items must be activated manually.

Sub Menu screen items offer the operator choices within a category. Some items have no Sub Menu while others may have more than one. You can get back to the previous menu or go on to the next menu.

Detail Menu screen items contain specific information. The operator must interact with the system to get results or to make changes. There is always a way to go back to the previous menus from this screen.

Use the control indicated to highlight an item on any menu. Only one highlighted item can be selected at a time. To return the game to normal, select EXIT TO GAME, then press the indicated button.

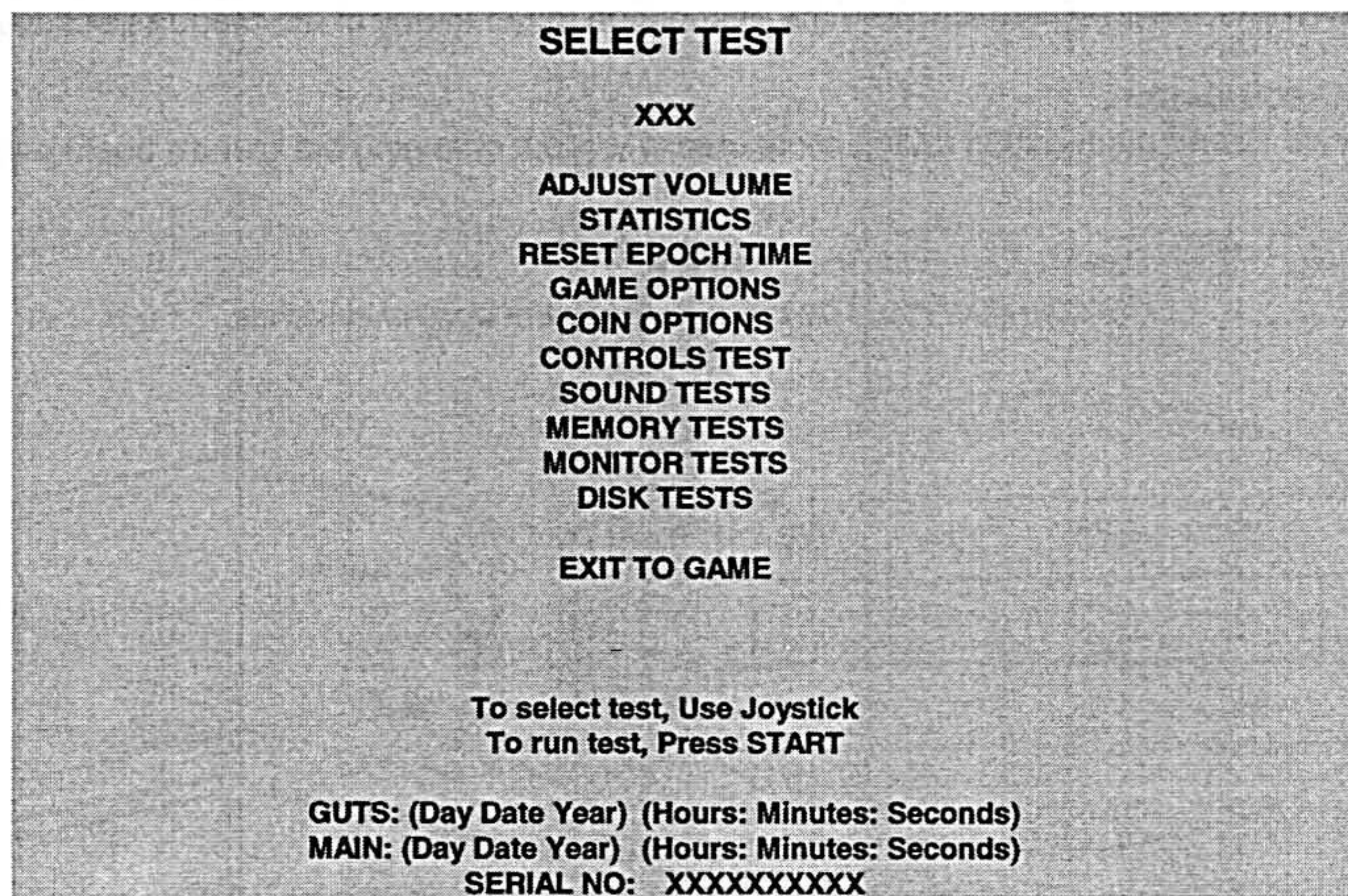

TYPICAL SELECT TEST MENU SCREEN

ADJUST VOLUME

The Adjust Volume feature allows the operator to determine the sound and music level of the game.

The volume level can be adjusted for either the Attract Mode or the Game. Press the Volume Up button to raise the volume level and the Volume Down button to lower the volume level. You may also move a joystick left or right to change the volume level. Music is played continuously while this screen is active.

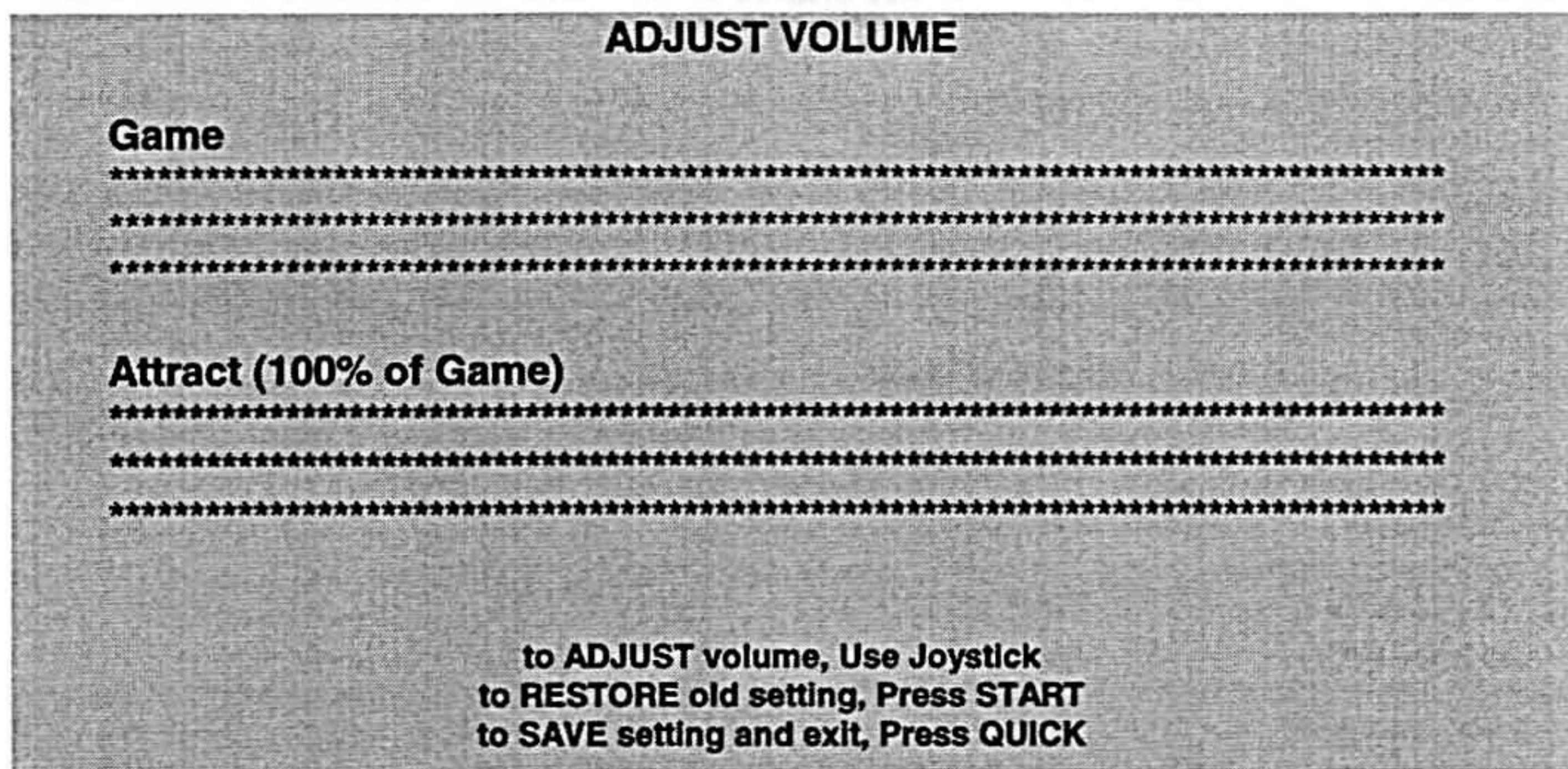

ADJUST VOLUME MENU SCREEN

Move a joystick up or down to choose either "Game" or "Attract" volume adjustment. When the selected variable is flashing on the screen, move the joystick left or right to change the level as desired.

The "Game" volume is continuously adjustable from zero to maximum. The game will seem more realistic to most players when they experience high volume sounds during play.

The "Attract" volume is continuously adjustable from Mute (zero) to maximum. For greater profits, adjust your volume levels to a loud setting to draw attention to this game.

The "Attract" and "Game" volume levels may be adjusted to different values independently, but "Attract" cannot be set higher than the level chosen for normal game play. If the "Game" level is lowered, it will automatically lower the "Attract" level. Lowering the "Attract" level will not affect the "Game" setting.

The current volume level is represented by the length of a bar made of dots. A longer bar indicates a higher volume setting than a short bar. Factory default for "Game" and "Attract" volume levels is 7.

Be certain to press only the QUICK button after any volume adjustments have been made. The START button will cancel any settings on the screen and return both levels to the previous screen values.

NOTE: These adjustments affect the volume of the tests as well as the game play. If the volume levels are set to minimum (zero), there will be no sounds from the speakers during any of the audio tests. It is recommended that the volume levels be set to a moderately high value each time the sound portion of the game or the speakers are checked. The levels may be returned to their previous settings after the tests have been completed.

STATISTICS

The Statistics report allows the operator to assess how well the game is being played. In addition to the earnings, various game aspects are tracked to determine the player skill levels.

Use a joystick to select a menu item. The joystick is also used to view the range of choices and change its value. Statistics may be reset to zero or allowed to increase after each viewing.

STATISTICS	
Mech 1 coins	:0
Mech 2 coins	:0
Mech 3 coins	:0
Mech 4 coins	:0
Bills	:0
Svc credits	:0
Idle Mins	:0
1 Player Mins	:0
2 Player Mins	:0
New Games	:0
Cont Games	:0
Total Games	:0
1 Player Games	:0
2 Player Games	:0
Error Count	:0
Total Coins	:0
Percentage Play	:0

To clear these counters, hold START and press QUICK
For more stats, Press QUICK

STATISTICS REPORT MENU SCREEN

The illustration shows how the report screen will look after the game has been reset or is first turned on. Most of the statistics will increase in value as the game is played. It is normal for some values to remain at zero: for example, the Mech 3 coins count will not change unless an additional Currency Acceptor has been installed in the game, and the Error Count will not change if no errors have occurred.

Low counts in both coin and player statistics may indicate that the game is too difficult for the skill levels of the players at this location; high continue counts may indicate that the game is not difficult enough. The difficulty level and other play characteristics may be adjusted from the Game Options menu.

It is recommended that the Statistics be recorded before any service or repairs are done on this game.

Press the QUICK button to view the additional game statistics. This will present game information such as frequency of game play, players progress with different game features, equipment faults detected, etc.

Press the START button to see HISTOGRAMS or USER MSGS screens. The Histograms allow you to compare game times, session lengths, player selections, etc. To return to the menu, press QUICK.

Hold the START button and press QUICK to cancel any settings on the screen and return all counts to the factory default values. There is no way to restore the previous values once defaults have been selected.

The HISTOGRAMS screens will have no bar graphs until the system has enough data to plot.

The USER MSGS screen will contain no messages until the system detects an error.

RESET EPOCH TIME

This adjustment returns the game and all time related events back to the beginning. The adventure through the dark ages starts over. All game characters appear again in their original order.

Use a joystick to select a menu item. The joystick is also used to view the range of choices and change its value. Options may be reset to factory defaults or left unchanged after each viewing.

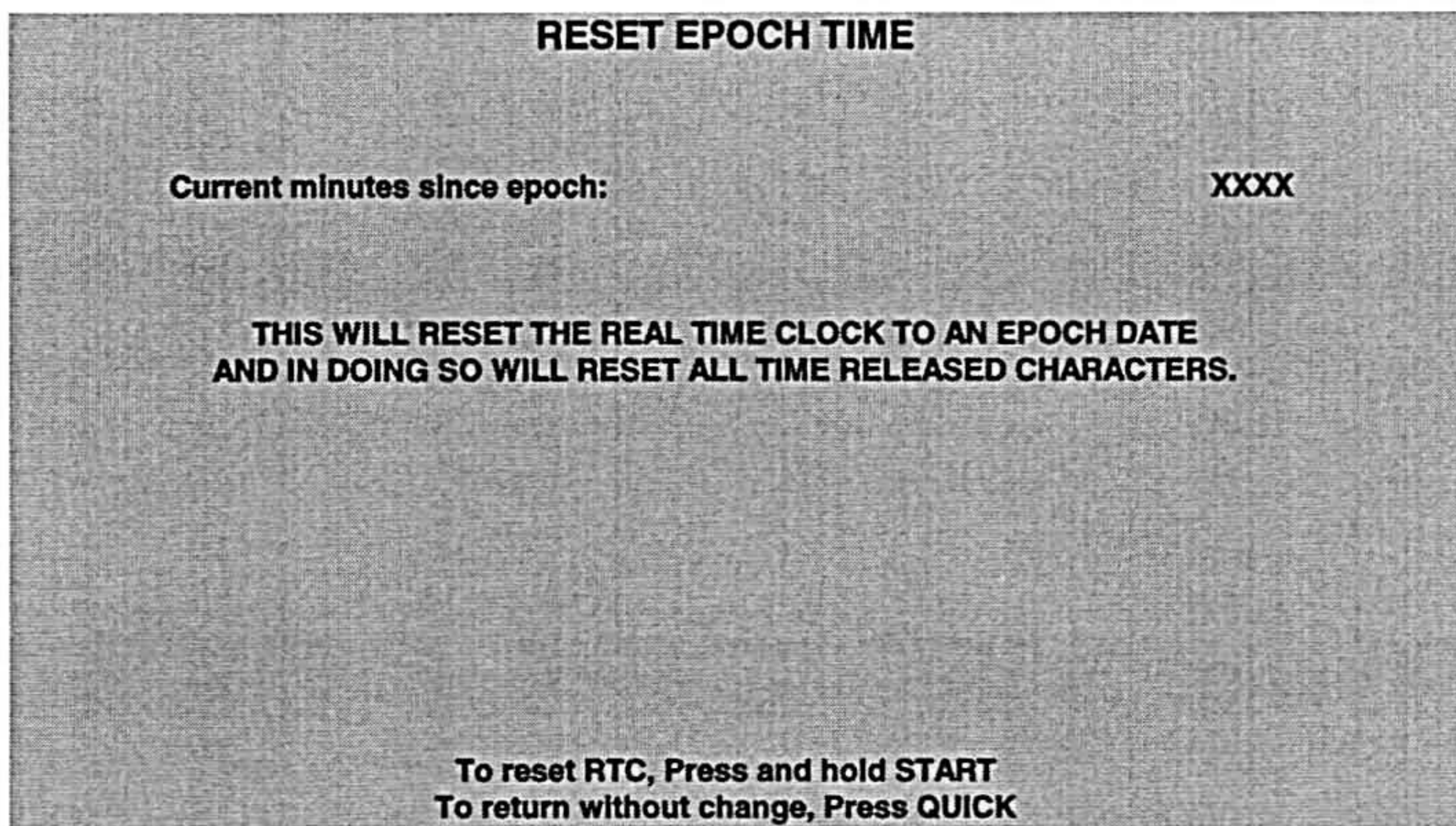

EPOCH TIME MENU SCREEN

The illustration shows how this epoch screen will look after the game has been reset or is first turned on. It is recommended that the statistics be recorded before this time reset is selected.

It is recommended that the High Scores be recorded before any option changes are done on this game.

Press and hold the START button to begin the reset process. An on-screen message will appear, indicating that a countdown is in progress. Release the button at any time during the countdown to abort the reset and return to the current values. When the count reaches Zero, data will be lost and time reset. This action returns the game to the beginning of the dark ages and starts a new epoch adventure.

NOTE: Once the epoch time has been reset, it clears out all previous data from game memory and cannot be restored. Changes to Epoch Time will automatically reset the Player High Scores, since this variable directly affects the ability to collect points.

GAME OPTIONS

These adjustments allow the operator to customize the game. Each of the variables will change some aspect of game appearance or play. Optimum settings cause high player interest and increase earnings.

Use a joystick to select a menu item. The joystick is also used to view the range of choices and change its value. Options may be reset to factory defaults or changed after each viewing.

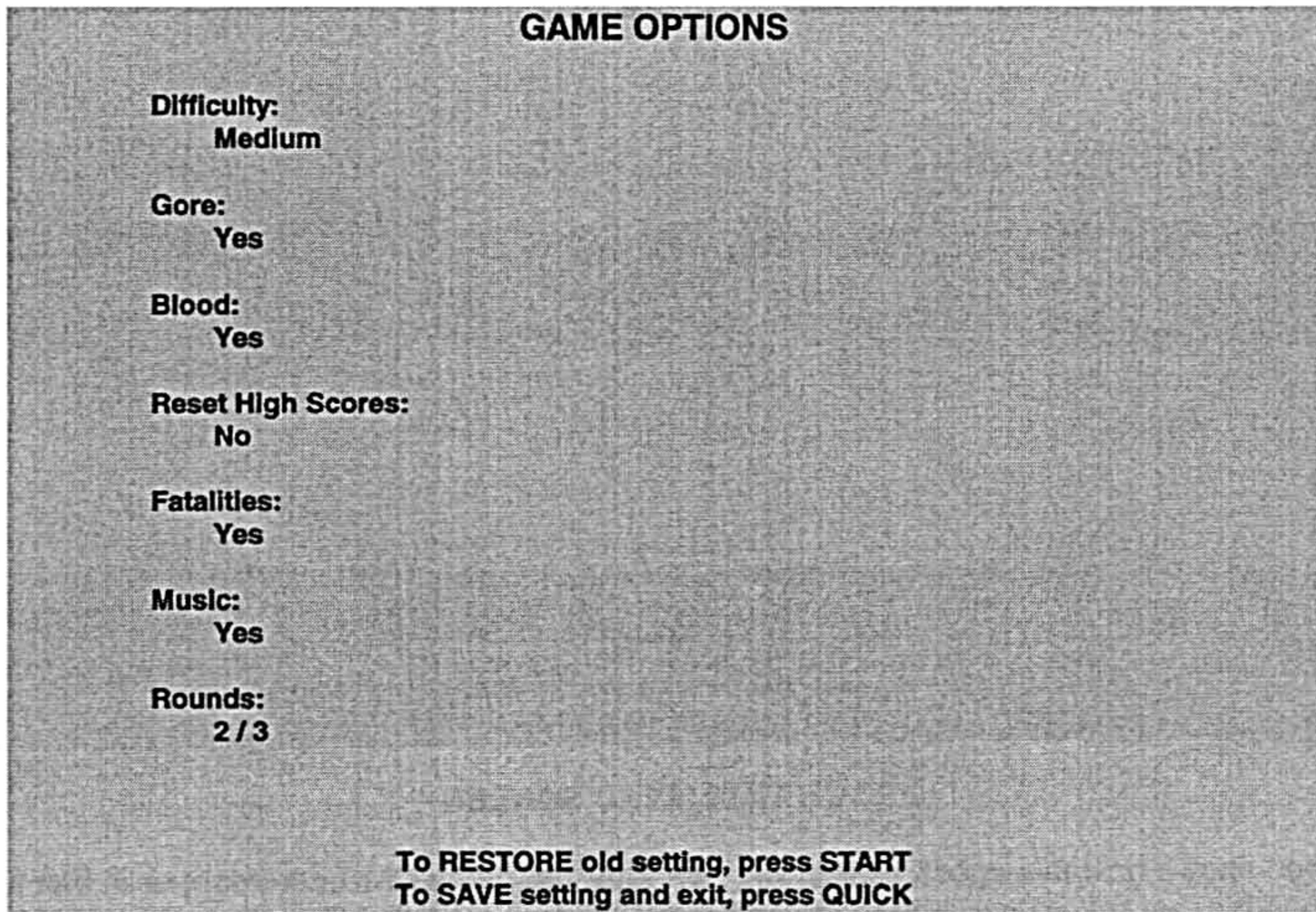

GAME OPTIONS MENU SCREEN

The illustration shows how this report screen will look after the game has been reset or is first turned on. Move a joystick left or right to advance a variable through its range of choices. Some items have more options than others. It is recommended that all of them be viewed before one is selected.

The effects of these options can be judged by comparing statistics reports before and after changes were made. As players become more familiar with the game, new features or increased difficulty will make the game challenging and continue to generate interest.

It is recommended that the High Scores be recorded before any option changes are done on this game.

COIN OPTIONS

The Coin Options are used to set up the coin mechanisms or bill validators and adjust the pricing of the games. Factory default values can be considered standard.

Use a joystick to select a menu item. The joystick is also used to view the range of choices and change its value. Options may be reset to factory defaults or changed after each viewing.

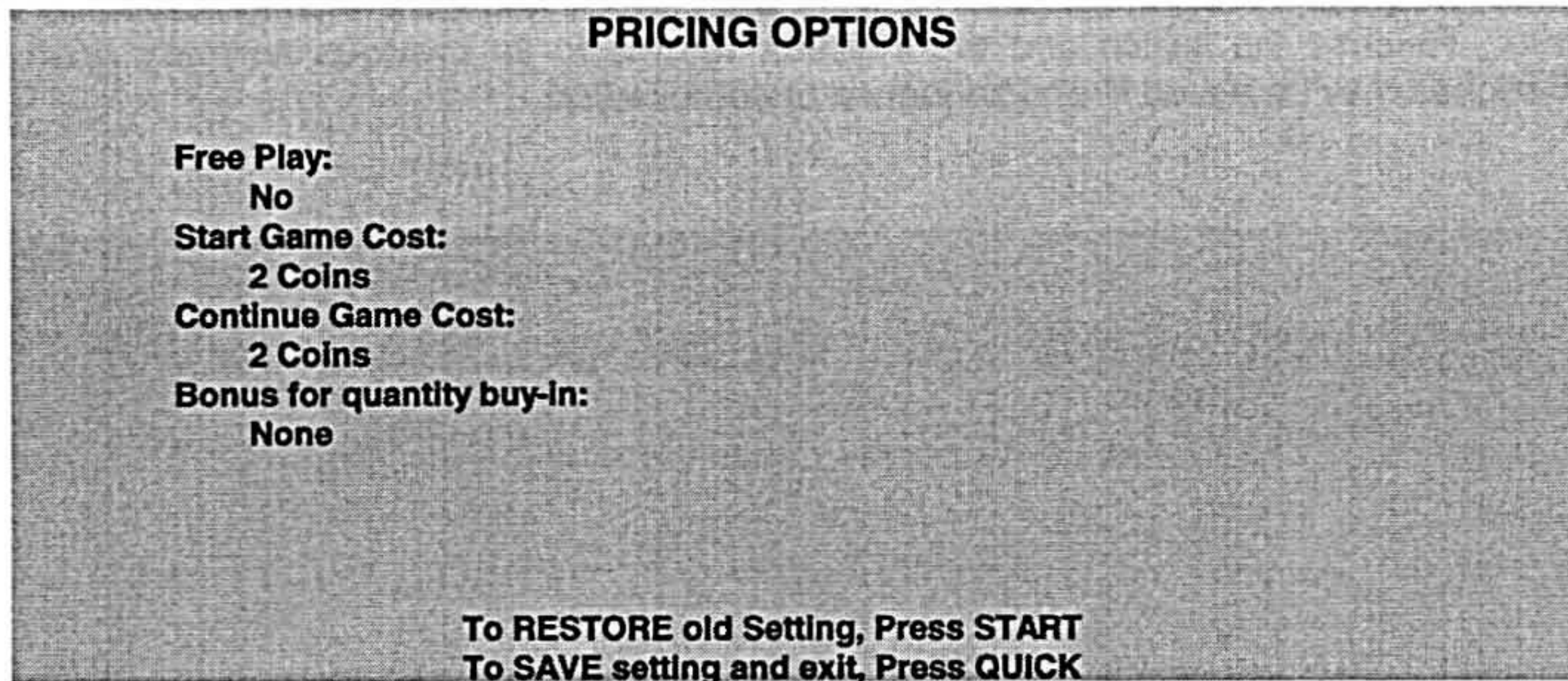

PRICING OPTIONS MENU SCREEN

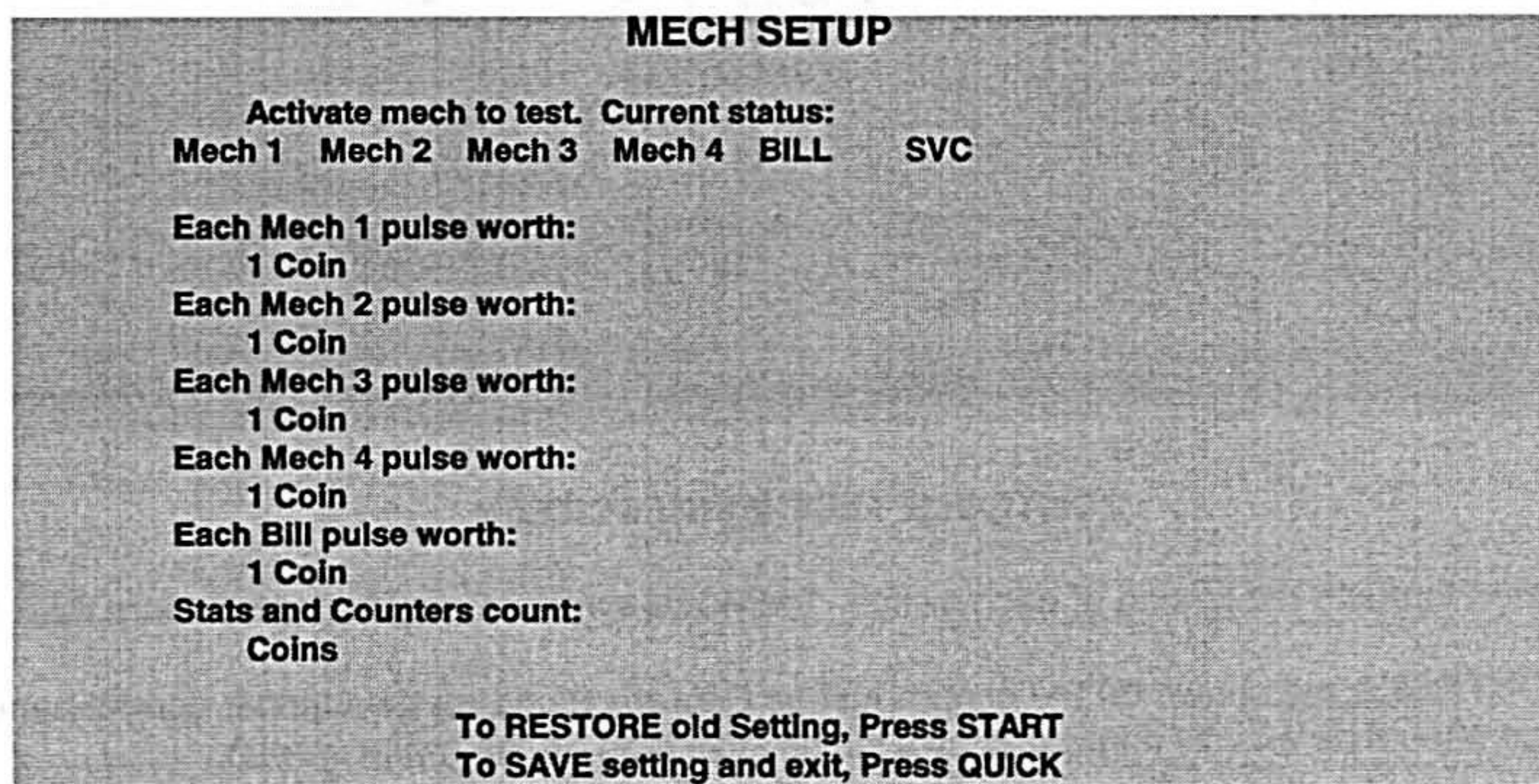

MECH SETUP MENU SCREEN

The illustrations show how these screens will look with all of the factory default settings. Move a joystick left or right to advance a variable through its range of choices. Some items have more options than others. It is recommended that all of them be viewed before one is selected.

PRICING OPTIONS

Custom pricing sets credits required to start and continue a game, rewards for buy-in and winning, etc. There are no other options if free play is selected. Free game player incentives may reduce earnings.

MECH SETUP

Mech setup permits the operator to add or remove coin or bill mechanisms. Although values are shown for all devices, changes to unused inputs will have no effect if there is no such mechanism in the game.

CONTROLS TEST

These tests allow the operator to manually check each switch in the game.

NOTE

Some switches may not be used with this game. Check the wiring diagram and the mech setup items.

Use any joystick to select the Controls Test. Activate each switch and the switch indication on the screen changes state. Release the switch and the indicator returns to its previous normally open or closed condition. Switches may be tested in any sequence or combination.

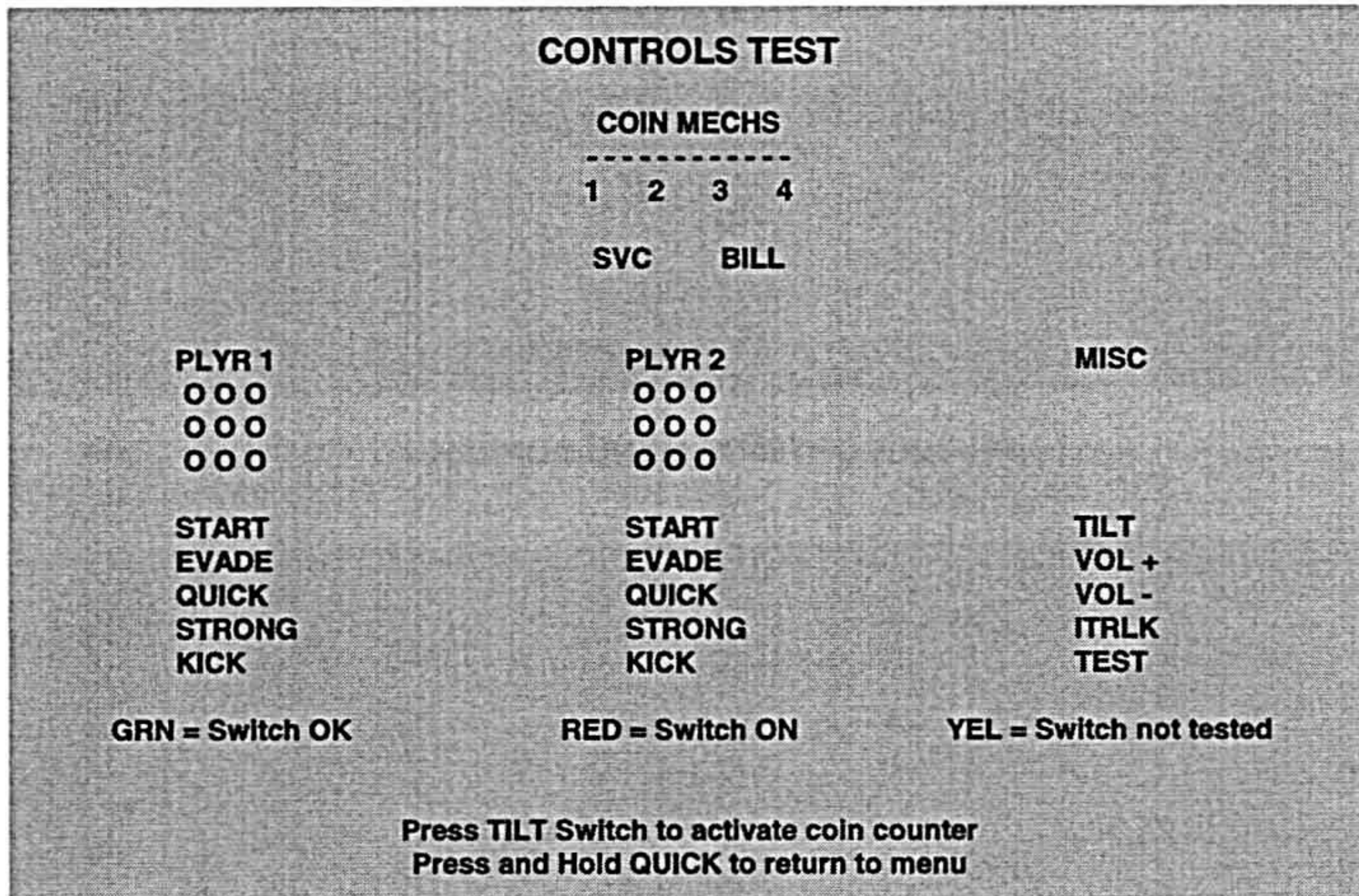

CONTROLS TEST MENU SCREEN

Colors are used to guide the testing of each switch. Individual switches may be tested more than once.

PLAYER CONTROLS are shown on the screen just as they are found on the cabinet control panel. Each switch change should be exactly duplicated by a single indication on the menu screen.

The Player Controls Tests are used to verify crossed wires, intermittent conditions, and stuck switches.

OPERATOR CONTROLS are shown on the screen just as they are found on the coin door bracket. Each switch change should be exactly duplicated by a single indication on the menu screen.

The Operator Controls Tests are used to verify crossed wires, intermittent conditions, and stuck switches.

The Coin and Cabinet Switches are shown on the screen without regard for their actual game location. Each switch change should be exactly duplicated by a single indication on the menu screen.

These Switch Tests are used to verify crossed wires, intermittent conditions, and stuck switches.

SOUND TESTS

These tests verify that the audio components are connected and operating properly.

NOTE

The level must be turned up for the speakers to be heard. Check the volume setting before testing.

Use a joystick to select the Sound Test. Move the joystick to choose either Audio Test. The selected test begins when the screen appears. There are no custom settings or adjustable variables in these tests.

Press and hold the QUICK button until the Sound Tests end to return to the main menu.



SPEAKER TEST MENU SCREEN

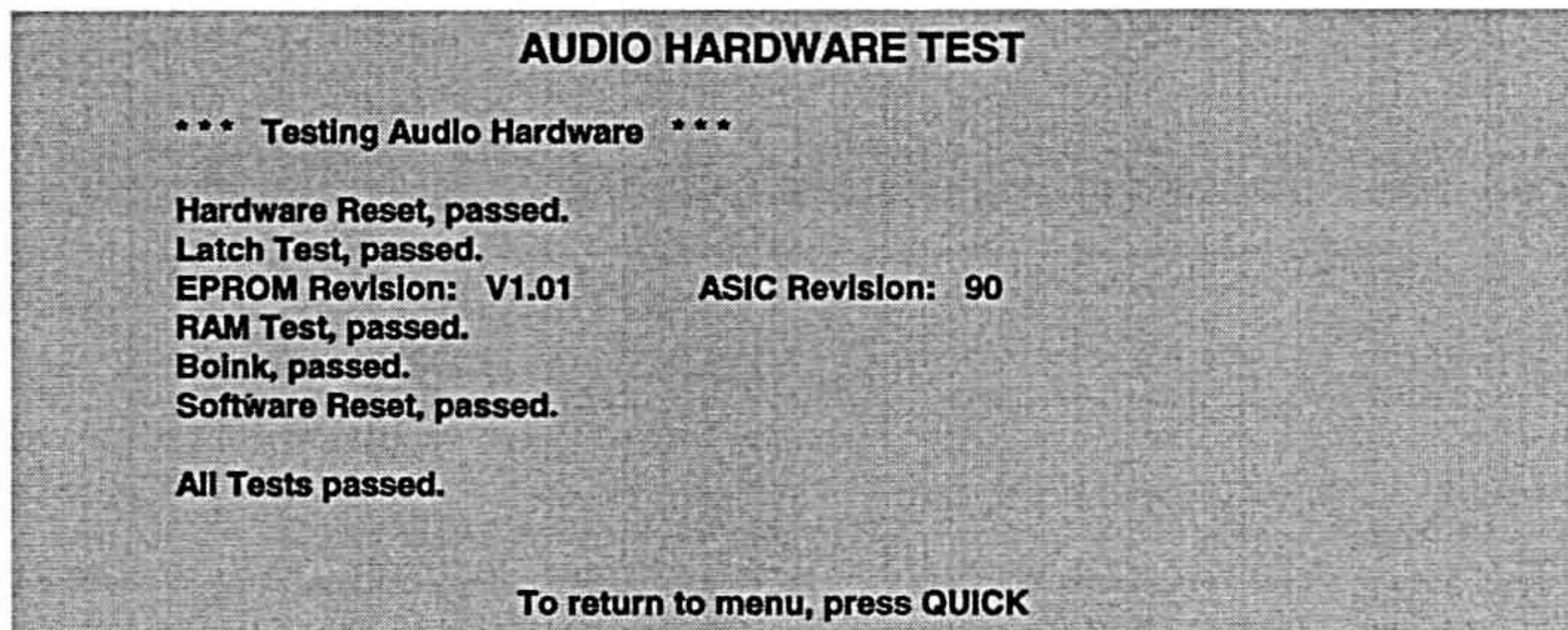

HARDWARE TEST MENU SCREEN

AUDIO SPEAKER TEST sends alternating left and right voice sounds to the individual speakers. The voices should be clear and distinct from each other. Each voice must come from the location identified.

The Audio Speaker Test screen is used to verify crossed connections, incorrect phase, and distortion.

AUDIO HARDWARE TESTS are a series of diagnostic routines that analyze the digital sound circuits. The results of the tests will be reported as pass or fail messages; sounds may also accompany the tests.

The Audio Hardware Tests are useful in locating digital circuit difficulties, especially when there are no sounds from the speakers. These tests detect sound memory and digital-to-analog conversion problems.

MEMORY TESTS

The Memory Tests allow the operator to verify some of the functions of the CPU Board Assembly RAM.

NOTE

These tests detect system errors, not actual game errors. The game program is on the Hard Disk Drive.

Use a joystick to select the Memory Tests. Move the joystick to choose Quick or Full Test. Press the START button to begin. There are no custom settings or adjustable variables in these tests.

Press and hold the QUICK button to halt the Memory Tests immediately and return to the main menu.

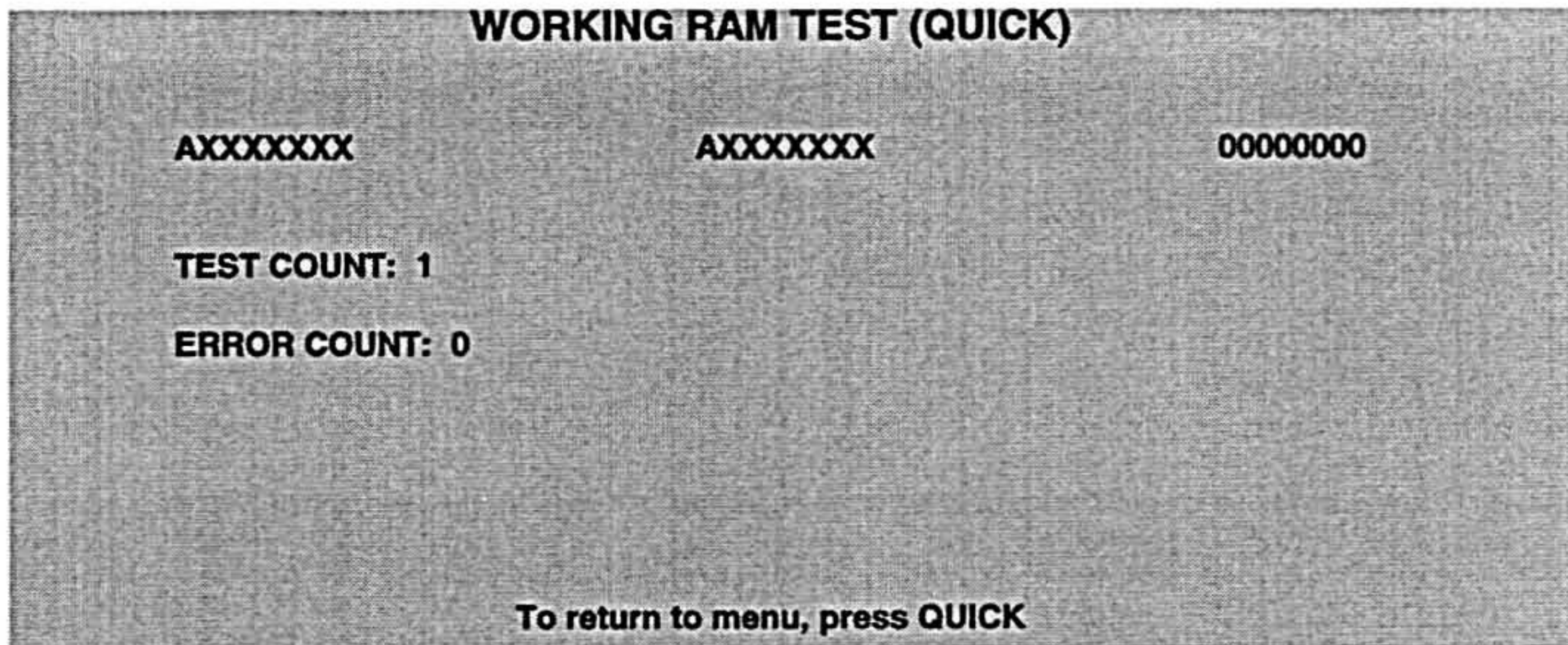

QUICK RAM TEST MENU SCREEN

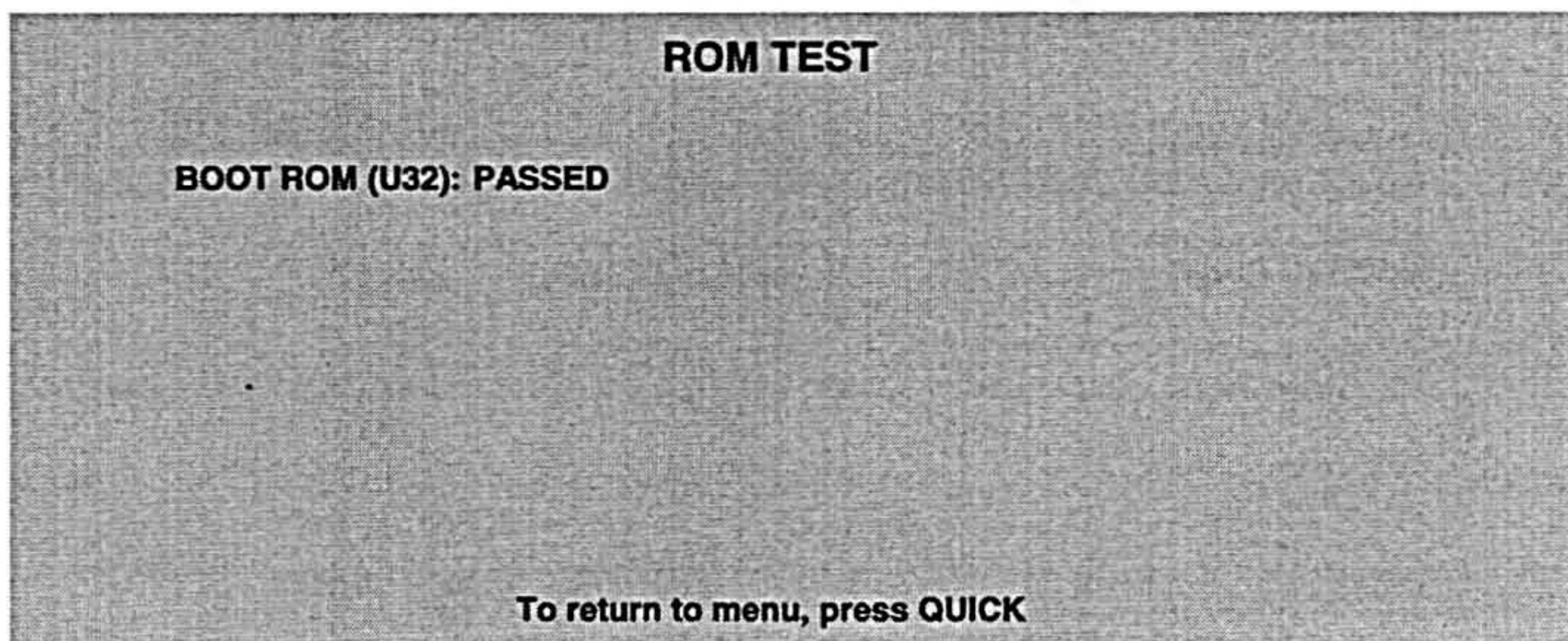

FULL RAM TEST MENU SCREEN

WORKING RAM (QUICK) performs a fast check of the storage area for the game variables. The results of the test will be reported as pass or fail messages; error messages may be included.

WORKING RAM (FULL) performs a more thorough check of the storage area for the game variables. The results of the test will be reported as pass or fail messages; error messages may be included.

ROM TEST performs a fast check of the game instruction memory. Results are reported as pass or fail.

Tests terminate automatically and return to the previous menu. The full test takes longer to complete.

MONITOR TESTS

The Monitor Tests provide patterns for verifying the monitor performance or making adjustments.

Use a joystick to select any item from the menu. Press the START button to begin the test. Once the chosen Monitor Tests screen appears, use a joystick to select an option, and the START button to begin it. Press the QUICK button at any time to return to the Monitor Tests menu screen.

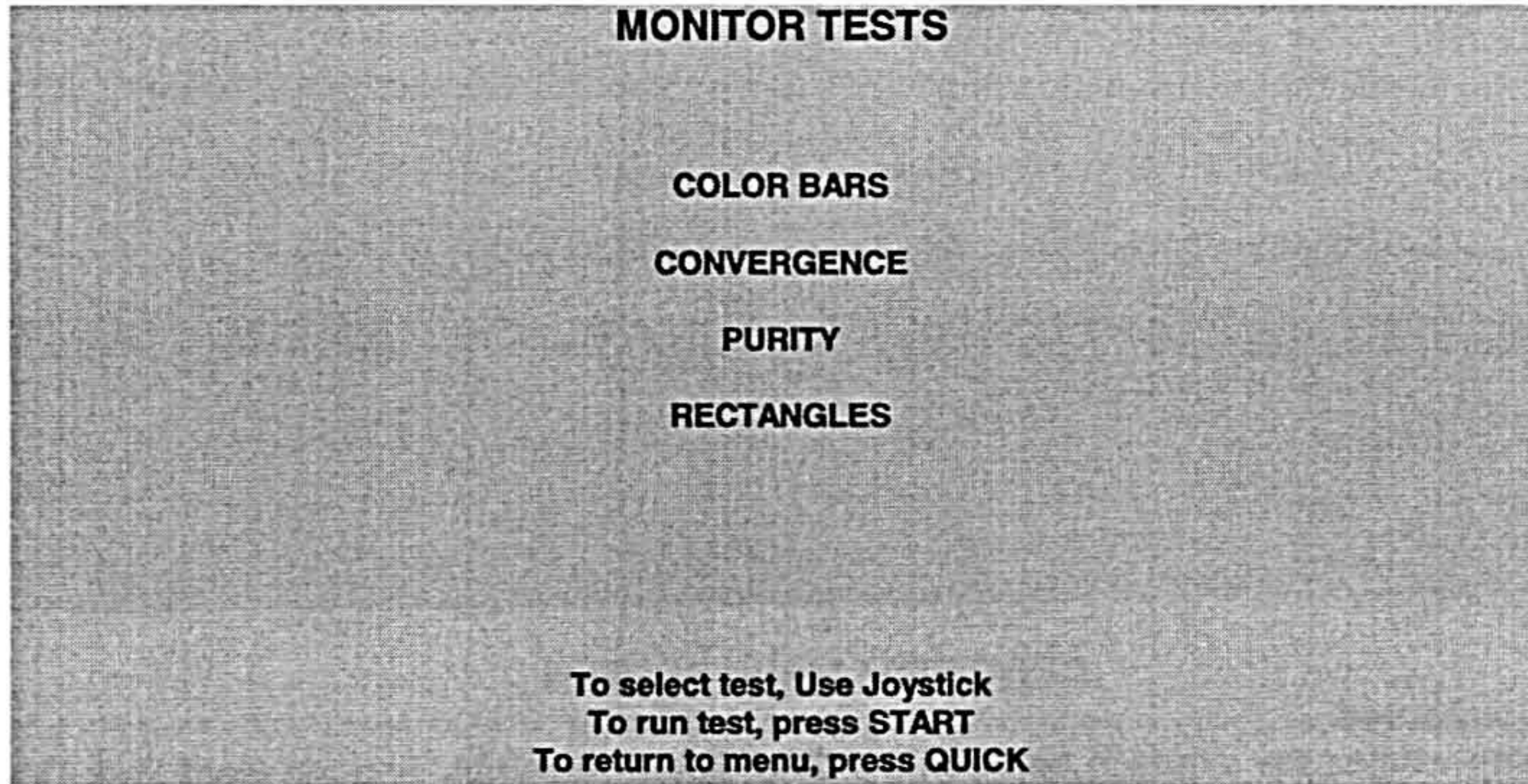

MONITOR TESTS MENU SCREEN

COLOR BARS fills the screen with shades of colors to verify red, green, blue and white level dynamic adjustments. Each color bar should appear sharp, clear, and distinct from bars on either side.

Borders must be visible on top, bottom, and both sides of the screen. The color bars should not change screen position or color as the background or border are removed or restored from the video display.

The Color Bars screen is useful in adjusting the monitor brightness and contrast.

CONVERGENCE tests fill the screen with a grid and a series of dots. The grid and the dots should be all one color, with no fringes or parallel images. The lines should be straight and the dots round.

Borders must be visible on top, bottom, and both sides of the screen. Lines and dots should not change screen position or color as the background or border are removed or restored from the video display.

The Convergence tests are useful in verifying the monitor convergence, linearity, and dynamic focus.

PURITY tests fill the screen with 100% of the chosen color at normal intensity. Each screen should be absolutely uniform from top to bottom and side to side. No retrace lines or noise should be visible.

Borders must be visible on top, bottom, and both sides of the screen. Image color should not change screen position or color as the background or border are removed or restored from the video display.

The Purity tests are useful in verifying monitor intensity, black level, blanking and automatic degaussing.

RECTANGLES tests display solid color boxes over a contrasting background screen. The rectangle should be centered with all four sides visible. The sides of the background should not be visible.

The Rectangles tests are useful in verifying scan size and screen uniformity.

DISK TESTS

The Disk Tests allow the operator to verify the functions of the Hard Disk Drive Assembly.

Use a joystick up or down to select a particular menu item. The joystick left and right moves are used to change variables. There are no custom settings or adjustable variables in these tests.

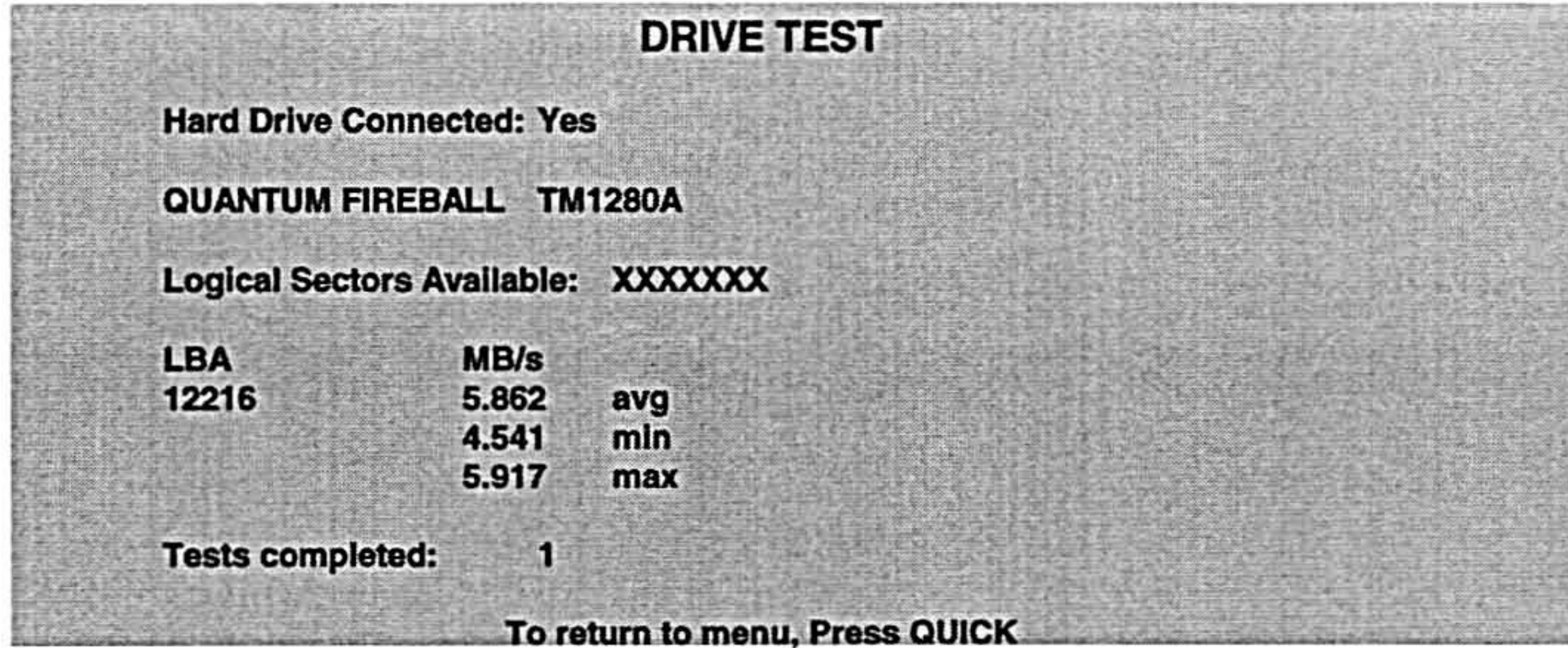

DRIVE TEST MENU SCREEN

Hard Drive Connected

This test routine verifies the interface between the CPU Board Assembly and the Hard Disk Drive itself. The processor requests disk information. Results report as yes or no; error messages may be included.

Drive ID

This line gives an industry standard identification of the Hard Disk Drive. This is a manufacturer hardware number only; it will not identify the software or the game program stored on the drive assembly.

Logical Sector Test

This test will perform a sector by sector read/verify test on the disk drive. As the status of each block of sectors is checked, the speed of the data transfer is compared to its acceptance limits.

Tests Completed

These tests run over and over. The number increases each time the cycle repeats (approx. 5 minutes).

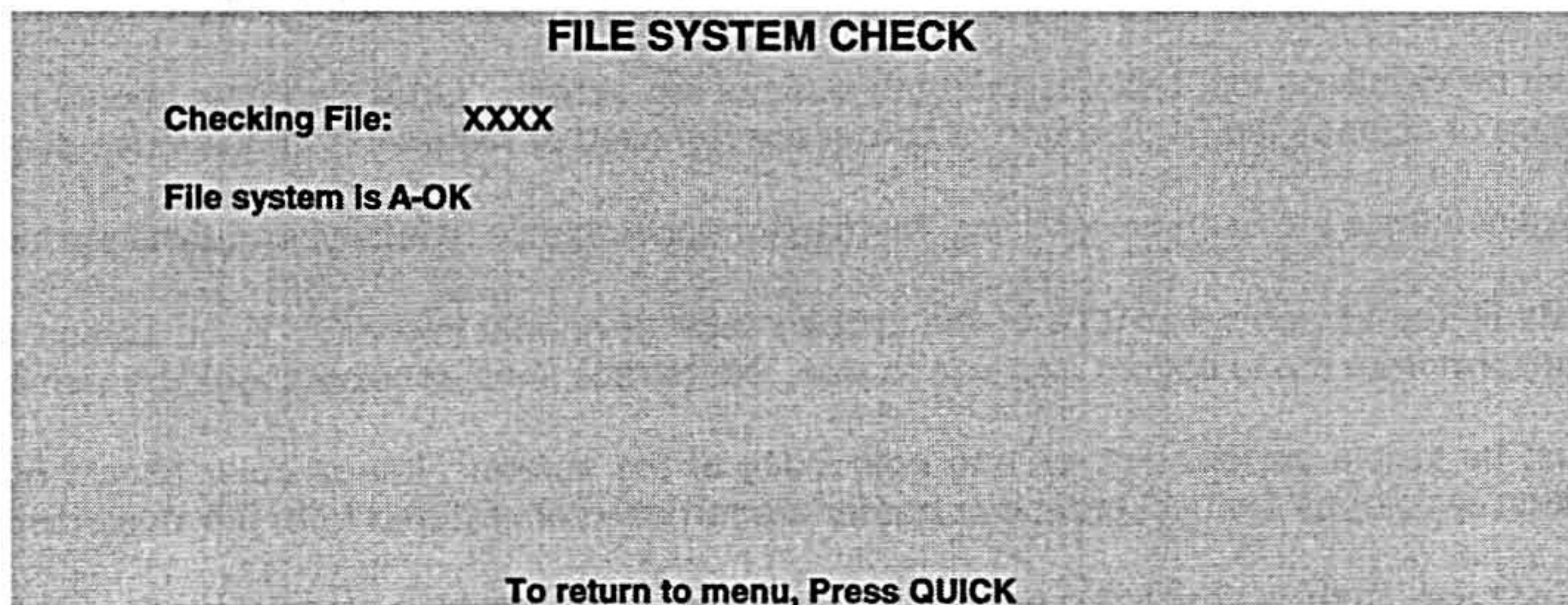

FILE SYSTEM MENU SCREEN

Checking File

This routine will perform a file by file check of data stored on the hard disk drive and report its findings. If errors are detected the system tries to fix them in the process (approx. 6 minutes per cycle). The system reports on the severity of the errors and advises if the game performance will be affected.

MACE™

THE DARK AGE

SECTION THREE

WIRING

Warning

Failure to reconnect all ground wires or replace metal shields and covers with each mounting screw installed and securely tightened may result in radio frequency interference.

JAMMA Chart

FUNCTION	WIRE COLOR	PIN	PIN	WIRE COLOR	FUNCTION
Ground	Black	A	1	Black	Ground
Ground	Black	B	2	Black	Ground
+5VDC	Red	C	3	Red	+5VDC
+5VDC	Red	D	4	Red	+5VDC
-5VDC	Yellow	E	5	Yellow	-5VDC
+12VDC	Orange	F	6	Orange	+12VDC
Key	N/C	H	7	N/C	Key
Coin Counter 2	Brown-Red	J	8	Brown	Coin Counter 1
Not Used	N/C	K	9	N/C	Not Used
Speaker -, Left	Brown-Gray	L	10	Red-Gray	Speaker +, Left
Speaker -, Right	Brown-White	M	11	Red-White	Speaker +, Right
Video Green	Green	N	12	Red	Video Red
Video Sync	White	P	13	Brown	Video Blue
Service Credits	White-Gray	R	14	Shield	Video Ground
Slam Tilt	Black-Green	S	15	Black-Blue	Test
Coin 2	Black-Red	T	16	Black-Brown	Coin 1
2 Start	Violet-White	U	17	White	1 Start
2 Up	Violet-Black	V	18	White-Black	1 Up
2 Down	Violet-Brown	W	19	White-Brown	1 Down
2 Left	Violet-Red	X	20	White-Red	1 Left
2 Right	Violet-Orange	Y	21	White-Orange	1 Right
2 Quick	Violet-Yellow	Z	22	White-Yellow	1 Quick
2 Strong	Violet-Green	a	23	White-Green	1 Strong
2 Evade	Violet-Blue	b	24	White-Blue	1 Evade
2 Kick	Violet	c	25	White-Violet	1 Kick
Not Used	N/C	d	26	N/C	Not Used
-5V Ground	Yellow-Brown	e	27	N/C	Not Used
Ground	Black	f	28	Black	Ground
SOLDER SIDE OF BOARD			COMPONENT SIDE OF BOARD		

Control Panel wires that are not part of the Main JAMMA Harness

Not Used	Grey-White	6	6	Blue-White	Not Used
Not Used	Grey-Black	7	7	Blue-Black	Not Used
Not Used	Grey-Brown	8	8	Blue-Brown	Not Used
Not Used	Grey-Red	9	9	Blue-Red	Not Used
Not Used	Grey-Orange	10	10	Blue-Orange	Not Used
Not Used	Grey-Yellow	11	11	Blue-Yellow	Not Used
Not Used	Grey-Green	12	12	Blue-Green	Not Used
Not Used	Grey-Blue	13	13	Blue	Not Used
Not Used	Grey-Violet	14	14	Blue-Violet	Not Used

D.C. Power Source Voltage Limits

FUNCTION	RANGE LIMITS	ID	ID	RANGE LIMITS	FUNCTION
Digital Circuits	+4.90V to +5.10V	+5V	-5V	-4.75V to -5.25V	Audio, Lights
Audio, DBV	+11.5V to +12.5V	+12V	NOTE: +5V is adjustable at the Power Supply		

CPU BOARD INDICATOR AND SWITCH LOCATIONS

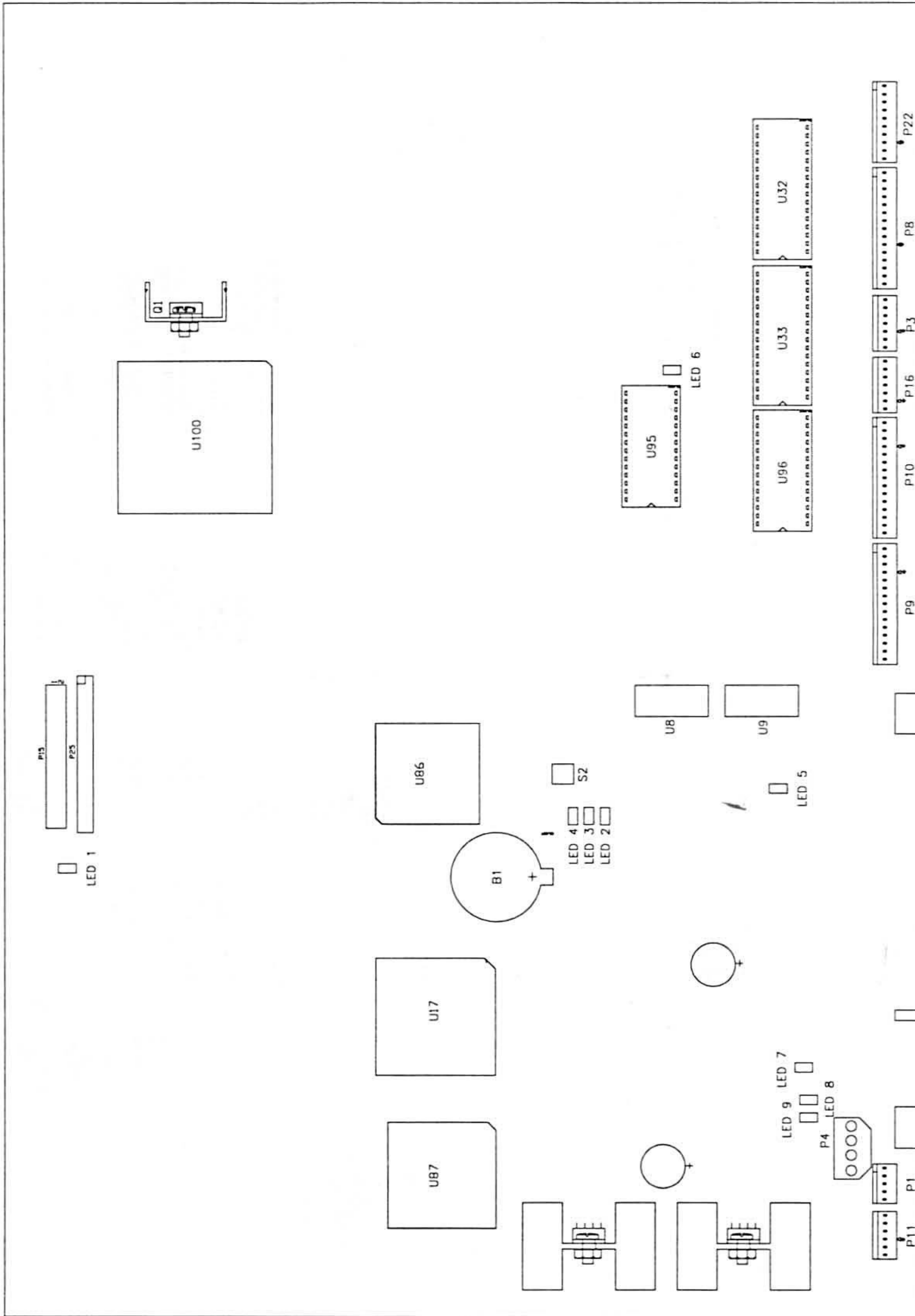

CPU SWITCHES

DESIGNATION	LOCATION	FUNCTION	POSITIONS	STATE	MEANING
S1	MIDDLE CENTER NEAR U41 & B1	WARM START RESET	1	OFF	NORMAL OPERATION
				ON	FORCED CPU RESET
U8	MIDDLE CENTER NEAR U20 & U94	SOFTWARE TEST MODES	8	OFF	FACTORY DEFAULTS
				ON	NOT USED FOR GAME OPERATION
U9	MIDDLE CENTER NEAR U20 & U94	SOFTWARE TEST MODES	8	OFF	FACTORY DEFAULTS
				ON	NOT USED FOR GAME OPERATION

CPU BOARD LED INDICATOR STATUS CHART

DESIGNATION	LOCATION	FUNCTION	COLOR	STATE	MEANING
LED 1 (HDD)	BOTTOM CENTER NEAR P15 & P25	HARD DISK ACTIVITY	RED	OFF	NOT IN USE
				ON	LOCKED UP (Note 1)
				BLINKING	NORMAL OPERATION
LED 2	MIDDLE CENTER NEAR B1 & S2	CPU RESET INDICATOR	RED	OFF	NORMAL OPERATION
				ON	PROCESSOR RESET
				BLINKING	RESET LOOP (NOTE 2)
LED 3	MIDDLE CENTER NEAR B1 & S2	INDICATOR	YELLOW	OFF	NORMAL OPERATION
				ON	PROCESSOR RESET
				BLINKING	RESET LOOP (NOTE 3)

NOTES:

1. Hard Disk Drive LED 1 only active in short bursts during game. May appear continuous during start up. If this LED is always on, there may be a fault that has caused the drive to be in a locked up condition.
2. LED 2 monitors a part of the ROM boot instruction set. Must be active only during power on or reset.
3. LED 3 monitors a part of the ROM boot instruction set. Must be active only during power on or reset.

CPU BOARD LED INDICATOR STATUS CHART (continued)

DESIGNATION	LOCATION	FUNCTION	COLOR	STATE	MEANING
LED 4	MIDDLE CENTER NEAR B1 & S2	INDICATOR	GREEN	OFF	NO BOOT ROM (NOTE 4)
				ON	PROCESSOR RESET
				BLINKING	NORMAL OPERATION
LED 5 (IOA)	UPPER CENTER NEAR U8 & U9	CONTROL ACTIVITY	GREEN	OFF	NO I/O FUNCTIONS PRESENT
				ON	NORMAL OPERATION
				BLINKING	I/O ASIC FAULT (NOTE 5)
LED 6 (SND)	UPPER LEFT NEAR U95 & U101	SOUND ACTIVITY	YELLOW	OFF	NO AUDIO ROM (NOTE 6)
				ON	READING ROM INSTRUCTIONS
				BLINKING	NORMAL OPERATION
LED 7 (+12V)	UPPER RIGHT NEAR C409 & L1	+12V POWER INDICATOR	RED	OFF	NO POWER
				ON	NORMAL OPERATION
				BLINKING	POWER FAULT (Note 7)
LED 8 (-5V)	UPPER RIGHT NEAR L2 & P4	-5V POWER INDICATOR	RED	OFF	NO POWER
				ON	NORMAL OPERATION
				BLINKING	POWER FAULT (Note 8)
LED 9 (+5V)	UPPER RIGHT NEAR P14 & R571	+5V POWER INDICATOR	RED	OFF	NO POWER
				ON	NORMAL OPERATION
				BLINKING	POWER FAULT (Note 9)

NOTES:

4. Boot ROM is only active in short bursts during start up. May appear very irregular during circuit reset.
5. I/O ASIC is only active in short bursts during start up. Must be on continuously during game play.
6. Sound is only active in short bursts during start up. Must be on continuously during game play.
7. LED 7 monitors a regulated power supply voltage source. Must be on continuously at all times.
8. LED 8 monitors a regulated power supply voltage source. Must be on continuously at all times.
9. LED 9 monitors a regulated power supply voltage source. Must be on continuously at all times.

MACETM

THE DARK AGE

SECTION FOUR

TROUBLESHOOTING

This game uses complex electronic components that are very SENSITIVE to static electricity. The following precautions must be observed and followed prior to handling any of the game electronics.

1. Ensure that the A.C. power to the game is turned OFF prior to servicing the electronics.
2. Discharge any static electricity build up in your body by touching the safety ground stud of the power supply chassis while the line cord is connected to a properly grounded outlet. This is to be done BEFORE touching or handling the electronic assemblies.
3. Store the electronic assemblies in an anti-static area. Anti-static bags are to be used to store or transport the game CPU Board Assembly.
4. DO NOT remove or connect any electronic assemblies when the cabinet power is ON. Doing so will damage the electronic assemblies and void the warranty.
5. Always replace ground wires, shields, safety covers, etc. when maintenance or service is completed. Ensure that all ground and mounting screws are installed and tightened firmly.

GAME DOES NOT START

1. Game appears completely non-functional; no audio, no illumination, no video display.

- A: Check that the Power Switch has been turned ON (top left rear corner of the game cabinet).
- B: Turn OFF the game power. Unplug the A.C. line cord. Unlock and remove the cabinet rear door. The Power Supply Line Voltage Switch must be set to agree with the local A.C. line voltage.
- C: Remove the Line Cord Cover Plate. Test the line cord, power plug and I.E.C. connector for breaks or damage. Verify the continuity of each wire in the cord. Fully seat the I.E.C. connector into the mating receptacle of the cabinet. Replace the cover plate and all four screws.
- D: Ensure that cabinet wiring harness connectors are fully seated in the corresponding A.C. Power Chassis Assembly connectors (refer to Power Wiring Diagram, Section Three).
- E: Examine the A.C. Line Fuse on the A.C. Power Chassis. If the fuse is faulty, replace it with an identical fuse from the spare parts bag. Replace the spare fuse when repairs are complete.
- F: Fully seat the A.C. plug in the outlet. Verify that A.C. line voltage is present. Turn the game power ON. Check the A.C. wiring harness and connectors if the fuse opens the circuit again.

2: Video game appears non-functional, but currency acceptor price indicator is illuminated.

- A: Unlock and open the coin door. Inspect the CPU Board Assembly under low light level conditions. A glow will be seen from the Light Emitting Diodes if there is voltage in the processor circuits. This does not mean that voltages or signals are as they should be, but it does indicate that the CPU Board is receiving some D.C. power from the Power Supply.
- B: Turn OFF the game power. Unlock, open and remove the rear door. Inspect the CPU Board Assembly. Ensure that the JAMMA Wire Harness connector is attached and fully seated onto the mating board connector. Check the other wiring harness connectors in the same way.

CAUTION: DO NOT REMOVE OR INSTALL ANY CONNECTOR WHEN POWER IS TURNED ON. DOING SO WILL DAMAGE THE GAME CPU BOARD ASSEMBLY AND VOID THE WARRANTY.

- C: Verify that the game CPU DIP Switches are set as intended. Refer to the DIP Switch Configuration Chart (Section One) for variables and default settings.
- D: Turn ON the game power. Using the 20 Volt D.C. setting on a digital voltmeter, measure D.C. voltages present at the Power connector pins. Adjust the +5V source if it is necessary. Refer to the Cabinet Wiring Diagram (Section Three) for specific wiring information and voltage limits.
- E: Using the 2 Volt A.C. setting on a digital voltmeter, measure the same D.C. voltages as above. Any reading here indicates that the supply voltages are unstable and may contain ripple or noise.
- F: Verify that the game runs and completes the power-up self-test sequence without any errors. Note errors and/or failures found during these tests.
- G: Enter the game Menu System by pressing and holding the TEST MODE switch inside the coin door. From the SELECT TEST menu, choose the MONITOR TESTS (refer to Section One for additional details). Use this set of tests to check the operation of each screen used in the game.

GAME CAN NOT BE PLAYED

1. Game will not accept currency or tokens and cannot be started. Audio and video are present.

- A: Unlock and open the cash door. Empty the cash box. Inspect the revenue for any counterfeit currency. Check the vault and remove any items that block the path from the mechanism.
- B: Unlock and open the coin door. Check each Acceptor by hand to ensure proper mounting. Remove the mechanism and clear the currency path. Reinstall the mechanism and latch it.
- C: Verify that the mechanism is level when the doors are closed. Repair or replace the coin door if it is bent or damaged. Adjust the cabinet leg levelers if necessary to keep mechanisms vertical.

2. Game accepts currency or tokens, but does not start. Audio and video are present.

- A: Unlock and open the coin door. Check each Acceptor by hand to ensure proper mounting. Verify that each of the release latches is in the closed and locked position. Test known good and bad coins to see if the mechanism accepts and rejects the currency correctly.
- B: Ensure that no loose parts or wires are caught in the hinges, latches, or switch contacts.
- C: Inspect to see if the external Acceptor indicators (Pricing, Flashing Arrows, etc.) are illuminated. Check connectors and cables for wiring continuity from CPU Board connectors to the Acceptors.
- D: Enter the game Menu System by pressing and holding the TEST MODE switch inside the coin door. From the SELF TEST menu, choose COIN OPTIONS (refer to Section One for additional details). Use these tests to confirm the pricing and setup of each mechanism used in the game.
- E: Check for continuity in each of the suspect switch connections (Common to Normally Open or Common to Normally Closed). Replace faulty switches (bent levers, broken actuators, etc.).
- F: Verify that each Acceptor is operating properly by placing it in a known good unit.

3. Player controls are intermittent or completely non-functional. Game starts normally.

- A: Unlock and open the coin door. Enter the game Menu System by pressing and holding the BEGIN TEST switch inside the coin door. From the DIAGNOSTIC TESTS menu, choose the SWITCH TEST (refer to Section One for additional details). Use these tests to confirm the operation of each switch used in the game.
- B: Reach through the coin door and unlatch the control panel. Grip the joysticks and carefully tilt the panel back on its hinge. Ensure that no loose parts or wires are caught in the hinges, latches, or switch contacts. Verify that the harness connectors are attached and fully seated.
- C: Check that the cabinet wiring is correct for this game. Ensure that the controls are properly connected to the control input wires from P9, P10, P12, and the JAMMA connector. Refer to the Cabinet Wiring Diagram (Section Three) for specific wiring information.
- D: Verify continuity in each of the switch connections (Common to Normally Open or Common to Normally Closed). Ensure that the control is operating properly by placing in a known good unit.

AUDIO PROBLEMS

1: Audio is non-functional, but video is present and game appears to operate normally.

- A: Unlock and open the coin door. Enter the game Menu System by pressing and holding the TEST MODE switch inside the coin door. From the SELECT TEST menu, choose ADJUST VOLUME (refer to Section One for additional details). Verify that the attract and game volume levels have not been set at Zero. Change the levels if necessary to make the game audible.
- B: Follow the on-screen instructions to return to the first menu. From the SELECT TEST menu, choose SOUND TESTS. Use these tests to confirm the operation of the speaker in the cabinet.
- C: Turn OFF the game power. Open the marquee and remove the glass. Inspect the speakers and harness. Ensure that no loose parts or wires are caught in speaker cones, terminals, mounting screws, or stuck to the magnets.
- D: Verify correct cabinet wiring for this game. Ensure that the speakers are properly connected to the audio output wires from the JAMMA connector. Verify speaker continuity. Refer to the Cabinet Wiring Diagram (Section Three) for specific wiring information.
- E: Turn ON the game power. Using the 20 Volt D.C. setting on a digital voltmeter, measure D.C. voltages present at the Power connector pins. Verify the +5V, -5V and +12V sources. Refer to the Cabinet Wiring Diagram (Section Three) for specific wiring information and voltage limits.
- F: Using the 2 Volt A.C. setting on a digital voltmeter, measure the same D.C. voltages as above. Any reading here indicates that the supply voltages are unstable and may contain ripple or noise.
- G: Verify proper operation of game CPU Board Assembly by placing it in a known good game.

2: The audio is distorted, muffled or missing frequencies. A constant low hum may be present.

- A: Unlock and open the coin door. Enter the game Menu System by pressing and holding the TEST MODE switch inside the coin door. From the SELECT TEST menu, choose SOUND TESTS. These tests will verify some of the functions of the audio circuits in this game.
- B: Turn OFF the game power. Open the marquee and check the speakers. This game uses coaxial speakers, not discrete woofer and tweeter units. Ensure that each speaker is FULL RANGE (100 to 10,000 Hz response) and rated for at least 25 WATTS.
- C: Check that the speaker wiring is not reversed at one of the speakers. Weak low frequencies and a thin or hollow sound quality is a symptom of incorrectly phased speakers. This condition may not be detected by the SOUND TESTS, but it will be audible during normal game operation.
- D: Check that the cabinet wiring is correct for this game. Verify that the cabinet wiring provides separate wires (not a common return) for each speaker. Ensure that all cabinet ground wires are connected. Refer to the Cabinet Wiring Diagram (Section Three) for specific wiring information.
- E: Using the 2 Volt A.C. setting on a digital voltmeter, measure voltages at the speaker terminals. Any reading here indicates that the supply voltages are unstable and may contain ripple or noise.
- F: Verify that the speaker is operating properly by placing in a known good unit.

VIDEO PROBLEMS

1. Monitor appears non-functional, but audio is present and controls operate as expected.

- A: Unlock and open the rear door. Verify that A.C. Power is connected to the Video Monitor. Inspect the neck of the CRT under low light level conditions. A glow will be seen near the CRT base if there is voltage in the filament circuits. This does not mean that other voltages or signals are as they should be, but it does indicate that some of the monitor circuits are receiving power.
- B: Turn OFF the game power. Verify that the Video Signal and the Remote Adjustment Board connectors are fully seated on the Video Monitor Board Assembly. Check the other monitor connectors in the same way. **Do not operate a monitor without a Remote Adjustment Board.**
- C: Examine the A.C. line fuse on the Video Monitor Board Assembly. If the fuse is faulty, replace it with an identical fuse of the proper voltage and current rating.
- D: Ensure that no loose parts or wires are caught on the chassis or the mounting brackets.
- E: Check that the brightness (intensity) and contrast have not been set to their minimum levels.
- F: Verify that the Video Monitor is operating correctly by placing it in a known good unit.

2: The power-up self-test will run, but the game does not appear. No audio is present.

- A: Note and record any error messages that occur during self-test. Open the coin door. Press and hold the TEST MODE switch to enter the menu system. From the SELECT TESTS menu, choose DISK TESTS. These tests will verify some of the Hard Disk Drive functions in this game.
- B: Turn OFF the game power. Unlock and remove the rear door. Inspect the CPU Board Assembly. Ensure that the JAMMA cable connector is fully seated into the mating edge connector on the CPU Board. Check the other cable connectors for correct alignment and continuity.

CAUTION: DO NOT REMOVE OR INSTALL ANY CONNECTOR WHEN POWER IS TURNED ON. THIS WILL DAMAGE THE CPU BOARD OR HARD DISK DRIVE AND VOID THE WARRANTY.

- C: Verify that the ROM instruction set is correct for this game. There is more than one ROM in a game set. Each ROM circuit is labeled with the assembly number and the software version.
- D: Verify that the CPU Board Assembly is correct for this game. Each CPU Board is marked with the manufacturer name, assembly number and the hardware version.
- E: Turn ON the game power. Using the 20 Volt D.C. setting on a digital voltmeter, measure D.C. voltages present at the Power connector pins. Verify the +5V source if it is adjustable. Refer to the Cabinet Wiring Diagram (Section Three) for specific wiring information and voltage limits.
- F: Using the 2 Volt A.C. setting on a digital voltmeter, measure the same D.C. voltages as above. Any reading indicates that the supply voltages are unstable and may contain ripple or noise.
- G: Compare CPU Board Light Emitting Diode states with the CPU Indicator Chart (Section Three).

3. Monitor will not lock onto the signal and provide a stable picture, colors are missing, etc.

- A: Check connectors and cables for wiring continuity from the CPU Board to the Video Monitor.
- B: Ensure that the Video Monitor Assembly is correct for this game. Use of video monitors with different resolution will result in what appears to be horizontal tearing or complete loss of sync.
- C: Verify that the Video Monitor is operating correctly by placing it in a known good unit.

4: Game operates normally, but video picture wavers or rolls, has dark bars, uneven colors, etc.

- A: Check connectors and cables for wiring continuity from the CPU Board to the Video Monitor.
- B: Ensure that all the cabinet ground wires are connected, especially at the Video Monitor Chassis.
- C: Move the cabinet farther away from machines, appliances, other games, etc. Very strong electrical or magnetic fields are emitted from some equipment when it is operating normally.
- D: Verify that the Video Monitor is operating correctly by placing it in a known good unit.

MISCELLANEOUS

1: Marquee lamp is intermittant or non-functional. Game starts and plays normally.

- A: Open the marquee and remove the glass. Remove the plastic lamp locks and the fluorescent tube from the holders. Install a new lamp if cracks or darkened ends are found. Clean the tube.
- B: Verify that the lamp and starter pins are making good connection with their socket contacts.
- C: Measure the Fluorescent Lamp Assembly A.C. voltages (Power Wiring Diagram, Section Three). Check wiring and connector continuity from the A.C. Power Chassis to the Lamp Assembly.
- D: Ensure that the Fluorescent Lamp Ballast is rated for the local A.C. line voltage and frequency.
- E: Check for continuity of both fluorescent lamp filaments, the starter, and the ballast. One at a time, verify that the lamp, starter, and ballast operate by placing each in a known good unit.

2. Game operates normally, but cabinet gets very warm after several hours of use.

- A: Check bottom and rear of cabinet for blocked air flow. Move game away from sources of heat.
- B: Turn OFF the game power. Apply high power vacuum cleaner to vent holes to remove dust.
- C: Unlock and remove the rear door. Ensure that all fans are connected and operating.

3. Error Messages appear on the screen. The game does not start and there is no audio.

- A: Check any assembly (RAM, ROM, Battery, etc.) identified in the Error Message.
- B: Call your authorized distributor for help with unresolved screen messages.