



DRAGON BREED™

DRAGON BREED® — OWNERS MANUAL

SAFETY

The following topics should be carefully studied to insure maximum reliability and safety for both serviceman and customer. Shock Hazard: The high voltage present on the monitor may be very dangerous. Extreme caution must be used when working with or around the monitors. Be certain that the grounding strap is attached to the monitor frame. The picture tube in the monitor is also a hazard and should be handled with care. Do not strike, scratch, or subject the tube to more than moderate pressure as it may implode causing serious injury from flying glass. Be certain that the control panel, power supply monitor, and coin door are all properly grounded to the ground wire inside the line cord. Do not remove ground prong off plug end.

PARTS LIST

- 1 - Plex Marquee
- 1 - Control Panel Overlay
 - 1 - FCC Cage
 - 1 - Graphic Sheet
 - 2 - Side Graphics
 - 1 - Manual
 - 6 - Buttons
- 1 - JAMMA Cable
- 1 - Marquee Art
- 1 - Dragon Breed PCB
- 1 - 8 Way Joystick & Hardware

IREM AMERICA®

8333 154th Avenue NE
Redmond, WA 98052
(206) 882-1093
(until 12-1-89)

FOR SERVICE CONTACT:

Your authorized Irem America® Distributor
or

SUMMIT SERVICE
2274 University Avenue
St. Paul, MN 55114
(612) 645-9077

DRAGON BREED® is protected by federal copyright laws and is the property of Irem America®. Any unauthorized versions of this game are illegal by federal law. AAMA protected stickers must be attached to the PCB. Please notify Irem America® of any boards not having the AAMA seal.

IMPORTANT F.C.C. WARNING

THIS EQUIPMENT GENERATES AND CAN RADIATE RADIO FREQUENCY ENERGY; IF NOT INSTALLED AND USED IN ACCORDANCE WITH THE INSTRUCTION MANUAL, IT MAY CAUSE INTERFERENCE WITH RADIO COMMUNICATIONS. AS TEMPORARILY PERMITTED BY REGULATION, IT HAS NOT BEEN TESTED FOR COMPLIANCE PURSUANT TO SUBPART J OF PART 15 OF FCC RULES, WHICH ARE DESIGNED TO PROVIDE REASONABLE PROTECTION AGAINST SUCH INTERFERENCE. OPERATION OF THIS EQUIPMENT IN A RESIDENTIAL AREA IS LIKELY TO CAUSE INTERFERENCE IN WHICH CASE THE USER, AT HIS OWN EXPENSE, WILL BE REQUIRED TO TAKE WHATEVER MEASURES NECESSARY TO CORRECT THE INTERFERENCE.

DANGER

An isolation transformer must be used with the monitor and power supply.

This game must be equipped with a three wire 110 volt plug for safety. Under no circumstance remove the ground plug.

DANGER

This game is designed with a JAMMA 56 pin connector. This plug is one of the finest operator friendly features in our industry today. What this means to you is that:

- 1) 1, 2, A, B, 27, 28, e and f are grounded
- 2) 3, 4, C and D are +5 volts
- 3) 5 and E are -5 volts
- 4) 6 and F are +12 volts

Also, all video and joystick functions are always in the same place. Once a cabinet is wired for JAMMA, it is easily changed from game to game.

Many older games such as Pac Man®, etc., have the power supply on the board. This will not work!!! Only a JAMMA connector with proper voltage will work. Irem America® recommends using an 11 or 15 amp switching power supply with **Dragon Breed®**.

MONITORS

Dragon Breed® is designed to be operated with a horizontal raster scan monitor with negative sync (RGB). This means **Dragon Breed®** will not work with any X-Y (Tempest, Space Dual, Star Trec), etc. An isolation transformer must be used in conjunction with the monitor. This is for your safety. The monitor also utilizes extremely high voltages. The monitor may also retain a charge for an extended period of time. Safety goggles must be worn while removing or replacing the monitor.

It is highly recommended that the monitor is verified good before the new **Dragon Breed®** kit is installed in your new and or rebuilt cabinet.

INSTALLATION OF KIT IN USED CABINET

To Disassemble:

1. Open back door and remove old board set and power supply, if you are using a new switching power supply.
2. Remove marquee glass and monitor glass.
3. Remove control panel and set aside.
4. Remove old wire harness, leaving 110 volt wiring intact. Also, leave the grounding straps to the monitor, coin door, control panel, and power supply intact.

Installation:

1. Mount the board set on the side panel of the cabinet as close to the middle of the game as possible (approximately 10-12" off bottom).
NOTE: Do not mount board directly below control or any vents or cracks so that liquids may seep on to the board. Do not forget about coins that may drop on to the board. Also, mount the board with edge connector facing up.
2. Mount the power supply on the bottom of the cabinet with connectors facing the rear of the cabinet. An optional mounting might be on the side panel just below the board set, connector to rear.
3. If the game does not have an isolation transformer, you must protect your customers and your game. Install one between the 110 volt line and your monitor/power supply.
4. Place the provided JAMMA wiring harness on the board. Connect the +5, +12, -5, and ground wires to the corresponding lugs on the power supply, connecting all the wires. If you don't, you will probably burn the board connector.
5. Run a wire from -5 volts to the coin door lights. Run a wire from +12 volts to the coin counters. This completes the power requirements.
6. Connect the Audio (+) and Audio (-) to the speaker.
7. Connect the video red, green, blue, ground, and sync to the corresponding wires on the monitor. If the monitor is not a negative composite sync, see sync modifications chart.
8. Cut the marquee to size. Replace the marquee lamp, if needed. Install the marquee panel.
9. Connect the coin 1 and coin 2 wires to the coin switches. Connect the coin counter 1 and coin counter 2 wires to the coin counters.

NOTE: If you only have one coin counter, see coin counter diagram. It will not matter if the coin counters are only rated at 6 volts, as the pulse is not long enough to burn out the counter.

10. Disassemble the control panel of all the hardware. Do not remove the old panel overlay. Determine where to place the new joystick and buttons if they must be repositioned. Then, cut new holes.

NOTE: If you are going to use plexiglass over the control panel, we suggest that you use a good 1/8" polycarbonate with a scratch resistant coating. We recommend GENERAL ELECTRIC LEXAN MR5 with margard or TUFFAK CM-2. These do not crack or break with abuse.

Cut and drill plex as needed. Remove the old control panel overlay carefully and apply the new overlay on top of the old glue. Use an Exacto knife to cut out any button or bolt holes. Apply decals for "1 player," "2 player," "jump," and "attack" over appropriate buttons. Now assemble the control panel.

11. Bolt the control panel to the cabinet. Now connect the 1P up/down, left/right, and jump/attack wires to the correct switches. Connect the 1 player and 2 player start wires.

NOTE: The 2P control wires need not be connected on upright cabinets, but only on the cocktail tables.

12. Power up the game. Look over your installation for errors, and then apply power, listening for unusual sounds. Check for smoke or sparks. If everything is okay, wire tie all wires to form a nice, neat wiring harness. Clean the cabinet inside and out. Measure the +5 volts on the furthest point from the edge connector and adjust 5 volts to 5.05 volts. Use a tinted plex over the monitor if there are burns in the screen. We suggest bronze or grey tinted plex. Touch up the cabinet with fresh paint, and then repair all cabinet dents or chips, using an auto body product called **Duraglass**. This is similar to bondo. You can consult your local auto body shop or auto parts supplier for this product, as well as advice on how to use it.

DRAGON BREED®

Irem America® recommends installing your new Dragon Breed® kit in only a new or refurbished cabinet. Installing Dragon Breed® in an older cabinet will result in lower earnings. The cabinet should be as follows:

1. horizontal monitor
2. 11 amp or larger power supply
3. monitor not laying down flat.

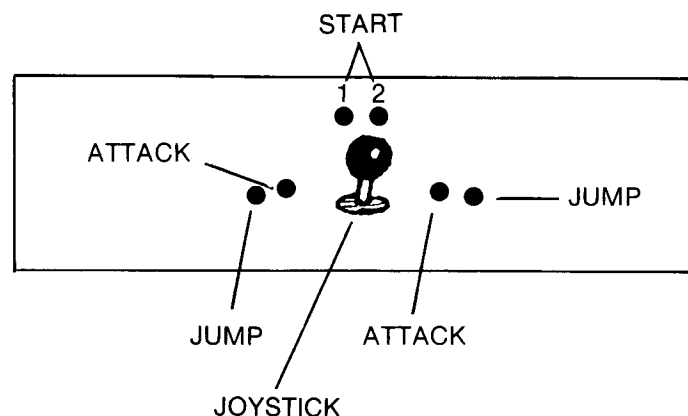

SPRING ACTION JOYSTICK

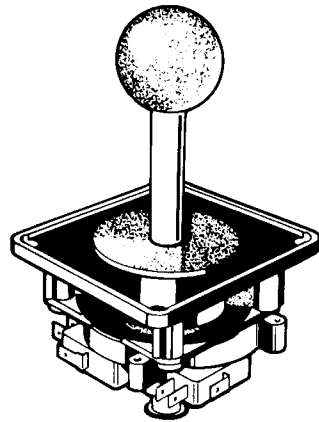

Featuring:

- Nylon and solid steel construction
- Spring return to center
- Micro or leaf switches individually replaceable
- Long shaft, 1.5 inch diameter red knob fitted as standard

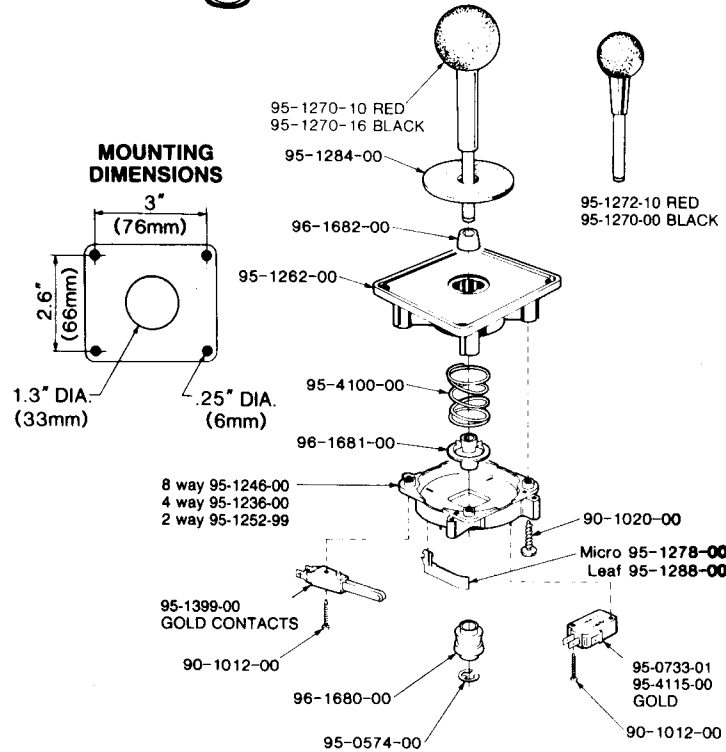

PARTS LIST:

90-1020-00	Switch Bracket Screw	95-1270-16	Black 1.5" knob & shaft
90-1012-00	M/S screw	95-1278-00	Microswitch protector
95-0574-00	E-Ring	95-1288-00	Leaf switch protector
95-0733-01	Microswitch	95-1284-00	2" Dia. washer
95-1246-00	8-way bracket	95-1399-00	Leaf switch, side mount
95-1236-00	4-way bracket		GOLD contacts
95-1252-99	2-way bracket	95-4100-00	.850 dia. spring
95-1262-00	Hub	96-1680-00	Actuator micro/switch
95-1270-00	Black 1.25" knob & shaft	96-1681-00	Z-Stop
95-1272-10	Red 1.25" knob & shaft	96-1682-00	Pivot cone
95-1270-10	Red 1.5" knob & shaft		

SPRING ACTION JOYSTICK		Price per ea.	1-24	25 +
50-5308-02	8-way microswitch joystick 1.25" knob	12.95	9.95	
50-5304-02	4-way microswitch joystick 1.25" knob	12.95	9.95	
50-4308-02	8-way leaf switch joystick 1.25" knob	12.95	9.95	
50-4304-02	4-way leaf switch joystick 1.25" knob	12.95	9.95	
50-5508-02	8-way microswitch joystick 1.5" knob	12.95	9.95	
50-5504-02	4-way microswitch joystick 1.5" knob	12.95	9.95	
50-4508-02	8-way leaf switch joystick 1.5" knob	12.95	9.95	
50-4504-02	4-way leaf switch joystick 1.5" knob	12.95	9.95	

HAPP CONTROLS, inc.

106 Garlich
Elk Grove, Illinois 60007

Phone: (312) 593-6130

Fax: (312) 593-6137

Telex: 297249 CONTROLS UR

Star Tech Tips

We are grateful to Star Tech Journal™ for allowing us to publish excerpts from their journal.

Monitor Sync

If your monitor does not have dual polarity positions for sync, you may use one of the following methods to get your game going.

CURE 1: Install a simple one I.C. circuit on your logic board. This I.C. may be "piggy backed" on to another 7404 series chip for power by bending up all but the two power pins so that they are parallel to the top surface of the new I.C. and then connecting the power pins only to the existing chip. (See Fig. 1) Next connect the sync wires as shown in Fig. 2. (Note: Figure 2 shows a hookup for either composite or separate syncs.)

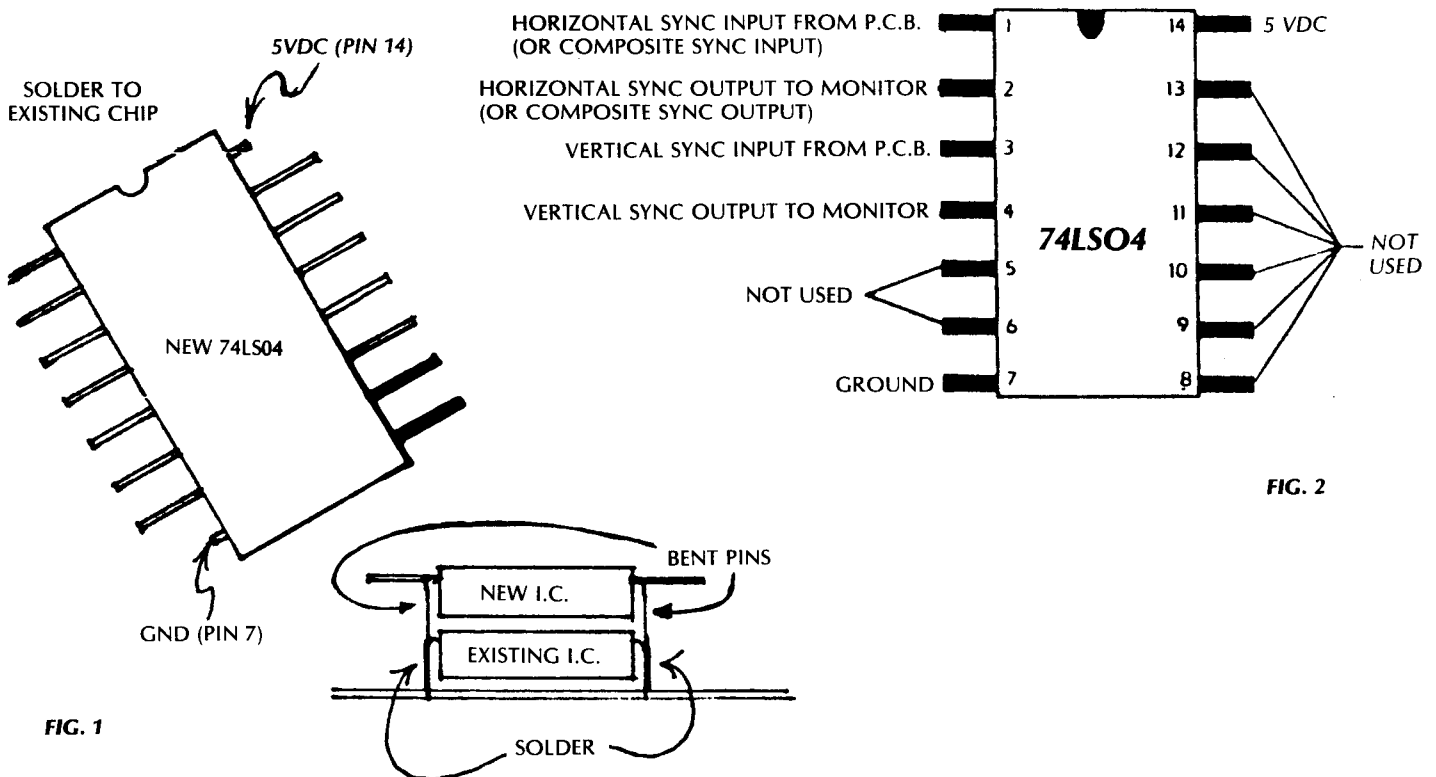

FIG. 2

CURE 2: Used for Wells-Gardner Video-Sync boards with positive sync connections only. (Vertical mount board 85x14 OB.)

Cut the traces on the solder side of the board between input pins 5 & 6 to the unbanded (anode) ends of diodes X201 & X202.

Add MPSA 56 transistor as follows:
 Collector to anode leads of diodes X201 & X202. Base pins 5 & 6 of the video input connector. Emitter to cathode (banded) lead of zener diode ZD201.

Insert a 1N4148 diode - cathode to the emitter of the MPSA56 and anode to the base. (See Fig. 3)

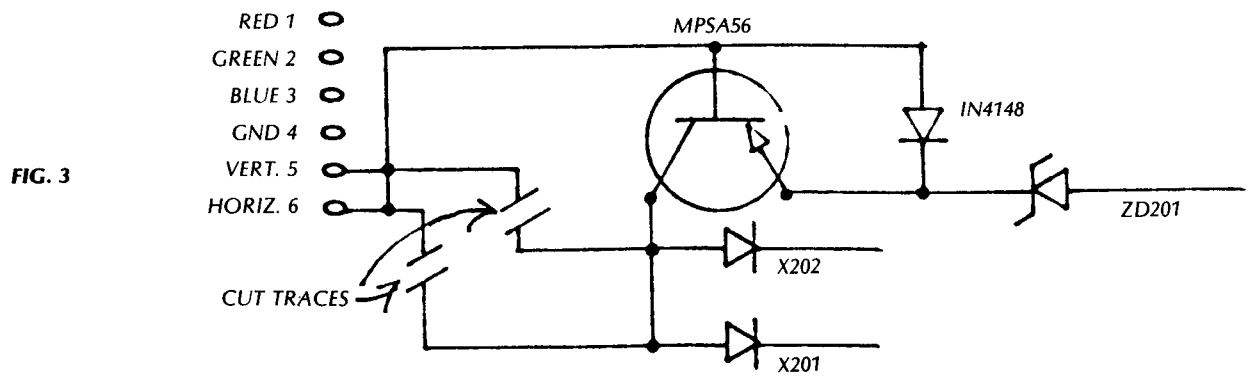

FIG. 3

2. Horizontal Tearing

CAUSE: The negative sync signal of most logic sets are slightly different than the GO7-CBO monitor negative sync inputs. The result of this mismatch is a horizontal "wave" or "curl".

CURE 1: On the monitor deflection board, replace C303 with a 10uf 25V radial lead capacitor with the positive lead towards the collector of X305. (CAUTION: be sure to check this step as the original cap is not polarized.) Then replace C501 with the cap removed from the C303 location.

CURE 2: Connect 1N4148 fast-switching diodes across both the positive and negative sync inputs to the monitor. (See Fig. 4) **NOTE:** Both diodes must be installed or you will not have vertical stability.

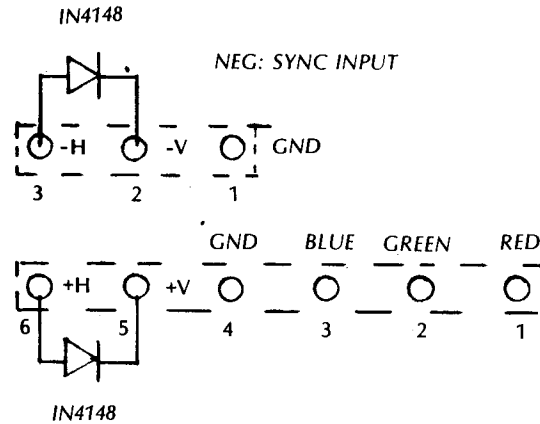

FIG. 4

CURE 3: Join negative sync inputs J2 and J3 together with a jumper. Locate W102 and install a jumper from W102 to either J2 or J3.

CURE 3: For Wells-Gardner K4600 series monitors.

Replace C356 (4.7uf 25V) on the Horizontal/vertical board (vertically mounted board nearest the flyback transformer) and center the horizontal hold pot. Turn L351 for the best horizontal stability and fine-tune with the horizontal width pot.

STAR TECH JOURNAL
P.O. Box 1065
18 N. Centre Street
Merchantville, J.J. 08109
609-662-1080

COIN COUNTER DIAGRAM

If only one coin counter is to be used install two diodes in the following manner:

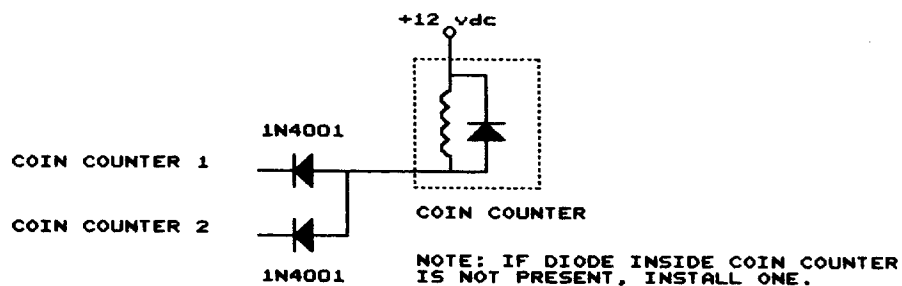

**DRAGON BREED®
JAMMA EDGE CONNECTOR/CABLE**

COMPONENT SIDE			SOLDER SIDE		
FUNCTION	COLOR	POS	POS	COLOR	FUNCTION
GROUND	BLK	1	A	BLK	GROUND
GROUND	BLK	2	B	BLK	GROUND
+5 VOLTS	RED	3	C	RED	+5 VOLTS
+5 VOLTS	RED	4	D	RED	+5 VOLTS
-5 VOLTS	BRN	5	E	BRN	-5 VOLTS
+12 VOLTS	BLU	6	F	BLU	+12 VOLTS
		7	H		
COIN COUNTER B	BLU/BRN	8	J	WHT/PUR	COIN COUNTER A
		9	K		
AUDIO POS +	WHT/BLK	10	L	BLK	AUDIO NEG -
		11	M		
VIDEO RED	RED	12	N	GRN	VIDEO GRN
VIDEO BLU	BLU	13	P	WHT	VIDEO SYNC*
VIDEO GND	BLK	14	R	BRN/WHT	SERVICE SWITCH
	YEL	15	S	WHT/BRN	
COIN INPUT 1	WHT/YEL	16	T	GRN/YEL	COIN INPUT 2
START 1	PNK/BLK	17	U	RED/BLK	START 2
1 P UP	ORG/BLU	18	V	BRN/BLU	2 P UP
1 P DOWN	GRN/ORG	19	W	ORG/WHT	2 P DOWN
1 P LEFT	GRN/BLU	20	X	ORG/GRN	1 P LEFT
1 P RIGHT	RED/YEL	21	Y	WHT/ORG	2 P RIGHT
1 P ATTACK	RED/WHT	22	Z	BRN/BLK	2 P ATTACK
1 P JUMP	WHT/RED	23	a	YEL/WHT	2 P JUMP
	YEL/BLK	24	b	BRN/GRN	
		25	c		
		26	d		
GROUND	BLK	27	e	BLK	GROUND
GROUND	BLK	28	f	BLK	GROUND

* Video sync composite negative

NOTE: 2 Player controls are used on cocktail tables and upright with player control option. 1 and 2 player games are not interactive.

KD/DYNAMO — UNIVERSAL VIDEO WIRING

**56 PIN EDGE CONN. PIN-OUT CHART
(JAMMA COMPATIBLE)**

COMPONENT SIDE			SOLDER SIDE		
FUNCTION	COLOR	POS	POS	COLOR	FUNCTION
GROUND	BLK	1	A	BLK	GROUND
GROUND	BLK	2	B	BLK	GROUND
+5 VOLTS	RED	3	C	RED	+5 VOLTS
+5 VOLTS	RED	4	D	RED	+5 VOLTS
-5 VOLTS	WHITE	5	E	WHITE	-5 VOLTS
+12 VOLTS	YELLOW	6	F	YELLOW	+12 VOLTS
KEY		7	H		KEY
COIN COUNTER #1	BRN	8	J		COIN COUNTER #2
COIN LOCK OUT 1	RED	9	K		COIN LOCK OUT 2
SP (+)	WHT	10	L	WHT/BLK	SP (-)
N.C.	BLUE-OPTION	11	M	BLU/BLACK	N.C.
VIDEO RED	RED	12	N	GRN	VIDEO GRN
VIDEO BLU	BLU	13	P	GRAY	VIDEO SYNC*
VIDEO GND	BLK	14	R	BRN/BLACK	SERVICE SWITCH
TEST SW.	BROWN	15	S	BRN/BLACK	TIL SW.
COIN SW. 1	WHITE	16	T		COIN SW. 2
START 1	GRAY	17	U	WHITE/GRAY	START 2
1 P UP	VIOLET	18	V	WHITE/VIOLET	2 P UP
1 P DOWN	BLUE	19	W	WHITE/BLUE	2 P DOWN
1 P LEFT	GREEN	20	X	WHITE/GREEN	2 P LEFT
1 P RIGHT	YELLOW	21	Y	WHT/YELLOW	2 P RIGHT
1 P PUSH 1	ORANGE	22	Z	WHT/ORANGE	2 P PUSH 1
1 P PUSH 2	RED	23	a	WHT/RED	2 P PUSH 2
1 P PUSH 3	BROWN	24	b	WHT/BROWN	2 P PUSH 3
N.C.	BLUE/WHT	25	c	GREEN/WHT	N.C.
N.C.	RED/WHT	26	d	YELLOW/WHT	N.C.
GROUND	BLK	27	e	BLK	GROUND
GROUND	BLK-OPTION	28	f	BLK-OPTION	GROUND

* Video sync composite negative

NOTE: 2 Player controls are used on cocktail tables and upright with player control option. 1 and 2 player games are not interactive.

DRAGON BREED® — JAMMA PIN OUTS — HORIZONTAL SCREEN — 1 x 8 WAY JOYSTICK 2 BUTTONS

DIP-1

FUNCTION		SWITCH	1	2	3	4	5	6	7	8		
NUMBER OF PLAYER		3	OFF	OFF	<i>2-25-9, SAC</i>							
		2	ON	OFF								
		4	OFF	ON								
		5	ON	ON								
DIFFICULTY		NORMAL			OFF	OFF	<i>2-25-9, SAC</i>					
		EASY			ON	OFF						
		HARD			OFF	ON						
		VERY EASY			ON	ON						
MODE 2 3 OF DIP SW 2 ON	COIN MECH. (A)	1 COIN 1 PLAY					OFF	OFF				
		2 COINS 1 PLAY					ON	OFF				
		3 COINS 1 PLAY					OFF	ON				
		5 COINS 1 PLAY					ON	ON				
	COIN MECH. (B)	1 COIN 2 PLAYS									OFF	OFF
		1 COIN 3 PLAYS									ON	OFF
		1 COIN 5 PLAYS									OFF	ON
		1 COIN 6 PLAYS									ON	ON
MODE 1 3 OF DIP SW 2 OFF		1 COIN 1 PLAY					OFF	OFF	OFF	OFF		
		2 COINS 1 PLAY					ON	OFF	OFF	OFF		
		3 COINS 1 PLAY					OFF	ON	OFF	OFF		
		4 COINS 1 PLAY					ON	ON	OFF	OFF		
		5 COINS 1 PLAY					OFF	OFF	ON	OFF		
		6 COINS 1 PLAY					ON	OFF	ON	OFF		
		1 COIN 2 PLAYS					OFF	ON	ON	OFF		
		1 COIN 3 PLAYS					ON	ON	ON	OFF		
		1 COIN 4 PLAYS					OFF	OFF	OFF	ON		
		1 COIN 5 PLAYS					ON	OFF	OFF	ON		
		1 COIN 6 PLAYS					OFF	ON	OFF	ON		
		2 COINS 3 PLAYS					ON	ON	OFF	ON		
		3 COINS 2 PLAYS					OFF	OFF	ON	ON		
		5 COINS 3 PLAYS					ON	OFF	ON	ON		
		8 COINS 3 PLAYS					OFF	ON	ON	ON		
		FREE PLAY					ON	ON	ON	ON		

N.B.

- 1) Select Coin Mode 1 in case a single coin selector or two selectors for coins of the same value are used.
- 2) Select Coin Mode 2 in case two coin selectors of coins of different values are used.

DIP-2

FUNCTION		SWITCH	1	2	3	4	5	6	7	8
FILP PICTURE	NO		OFF							
	YES		ON							
CABINET TYPE	TABLE			OFF						
	UPRIGHT			ON						
COIN MODE	MODE 1				OFF					
	MODE 2				ON					
SOUND IN DEMO	NO					OFF				
	YES					ON				
CONTINUE	YES						OFF			
	ON						ON			
FREEZE PICTURE	NO							OFF		
	YES							ON		
DIAG. TEST	NO									OFF
	YES									ON

N.B.

In the freeze picture mode, press 2P-Start button to freeze and 1P-Start button to restart the game.

Diagnostic Test

(1) Test Items

The following tests are made:

- 1 RAM Test
- 2 ROM Test
- 3 I/O PORT Test
- 4 DIP Switch Test
- 5 SOUND Test
- 6 CHARACTER Test
- 7 COLOR Test

As soon as the number 8 of the DIP Switch 2 is turned to "ON" and the Power Switch is switched on, the Test 1 and 2 are started.

To finish the Tests, turn off the Power Switch and then the number 8 of the DIP Switch 2 to "OFF".

(2) Test Procedures

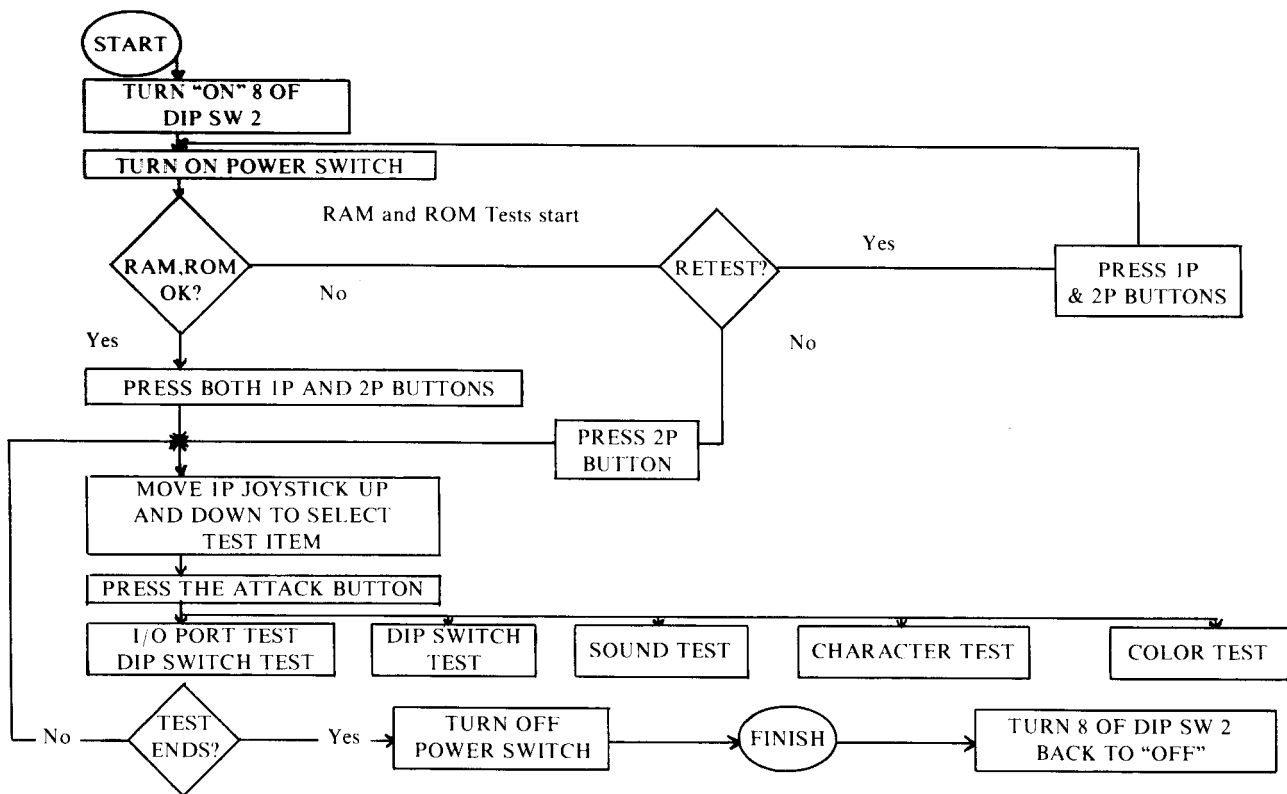

(3) RAM and ROM TEST

Although the picture does not appear on the screen and only various patterns appear on it for a while after turning on the power switch, RAM's for the picture are being tested during this time. If RAM's are found OK by the test, "RAM OK" and "ROM OK" will be displayed on the screen.

If RAM(s) is (are) not good, "RAM NG " will appear on the screen.

The figure following the RAM NG" indicates the location of the defective RAM.

1. WORK RAM (BYTE CHECK)
2. WORK RAM (WORD CHECK)
3. V_RAM A (WORD CHECK)
4. V_RAM B (WORD CHECK)
5. SOUND_L (BYTE CHECK) 0000 through 7FFFH
6. SOUND_H (BYTE CHECK) 8000 through FFFFH

If ROM(s) is(are) defective, "ROM NG " will appear on the screen.

When RAM's and ROM's are found all good after completing this RAM and ROM TEST, you can move over to the next test item by pressing the 1P and 2P start buttons.

In case any RAM(s) or ROM(s) is(are) found faulty after completing the RAM and ROM TEST, you can have the test repeated by pressing the 1P and 2P start buttons.

(4) Display of the Test Items

The following test items are shown so that you may select a test item you want by moving the 1P joystick up and down:

1. I/O
2. SOUND
3. CHARACTER
4. COLOR

Press the Attack button to get the test indicated in red started. Press the 1P and 2P start buttons to end the same test.

(5) I/O Port Test

The status when each joystick, button, and coin is turned "ON" is shown.

	8 7 6 5 4 3 2 1 8 7 6 5 4 3 2 1	,
IN PORT 1	0 0 0 0 0 0 0 0 0 0 0 0 0 0 0 0	
IN PORT 2	1 1 1 1 1 1 1 1 0 0 0 0 0 0 0 0	
DIP SW	1 0 0 0 0 0 0 0 0 0 0 0 0 0 0 0	

(0-OFF, 1-ON)

(6) Sound Test

The screen shows the number of each sound and the test is made about whether the corresponding sound is given. Push down the 1P joystick to move over to the next sound's test.

(7) Character Test

The player character is displayed in the center of the screen.

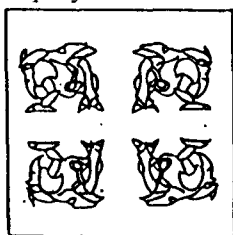

Make sure that the character is shown vertically and horizontally reversed as shown on the left.

(8) Color Test

By moving down the 1P joystick, the test can be advanced like

1 → 2 → 3 → 4 → 5 → 6 → 7 → 8 → 1

- 1 The whole screen shows only blue color.
- 2 The whole screen shows only red color.
- 3 The whole screen shows only magenta color.
- 4 The whole screen shows only green color.
- 5 The whole screen shows only cyan color.
- 6 The whole screen shows only yellow color.
- 7 The whole screen shows only white color.
- 8 A color pattern is displayed as illustrated on the right.

