




ROAD RIOT 4WD



UNIVERSAL KIT INSTALLATION INSTRUCTIONS

LINK-CAPABLE

Contact your distributor
for details



For technical assistance:

If reading through this manual does not lead to solving your game maintenance or repair problem, call TELE-HELP® at one of these Atari Games Customer Service offices:

UNITED STATES

Atari Games Corporation
California Customer Service Office
737 Sycamore Drive
Milpitas, CA 95036-1110
Fax (408) 434-3945
Telex 5101007850
☎ (408) 434-3950

(Monday-Friday, 7:30 a.m.-4:00 p.m. Pacific time)

EUROPE

Atari Games Ireland Limited
European Customer Service Office
Tipperary Town, Ireland
Fax 062-51702
Telex 70665
☎ 062-52155

(Monday-Friday, 9:00 a.m.-5:30 p.m. GMT)

ROAD PIOT 4WD



Universal Kit Installation Instructions

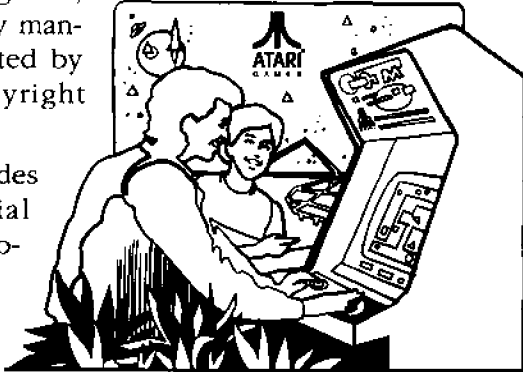
Conversion kit for upright games

Copyright © 1991 by Atari Games Corporation. All rights reserved.

No part of this publication may be reproduced by any mechanical, photographic or electronic process, or in the form of a phonographic recording, nor may it be stored in a retrieval system, transmitted, or otherwise copied for public or private use, without permission from the publisher.

The game play, all graphic designs, this technical manual, its accompanying schematic diagrams, and the display manual are protected by the U.S. Copyright Act of 1976.

This Act provides for substantial penalties for violating federal copyright laws. Courts can impound



infringing articles while legal action is pending. If infringers are convicted, courts can order destruction of the infringing articles.

In addition, the Act provides for payment of statutory damages of up to \$50,000 per infringing transaction in certain cases. Infringers may also have to pay costs and attorneys' fees and face an imprisonment of up to five years as well as fines of up to \$250,000 in the case of individuals and up to \$500,000 in the case of corporations.

Atari Games Corporation will aggressively enforce its copyrights against infringers. We will use all legal means to immediately halt any manufacture, distribution, or operation of a copy of video games made by us. Anyone who purchases such copies risks forfeiting such a game.

Published by:

Atari Games Corporation
675 Sycamore Drive
P.O. Box 361110
Milpitas, California 95036

Printed in the U.S.A. **01/92**

Produced by the Atari Games Technical Publications Department.

Writing and Editing: Andrea Dencker

Illustration and Design: Mary Ohanessian Sumner

**NOTICE RE.
NON-ATARI
PARTS**

WARNING

Use of non-Atari parts or modifications of any Atari game circuitry may adversely affect the safety of your game, and may cause injury to you and your players.

You may void the game warranty (printed on the inside back cover of this manual) if you do any of the following:

- Substitute non-Atari parts in the game.
- Modify or alter any circuits in the game by using kits or parts *not* supplied by Atari Games Corporation.

NOTE

This equipment generates, uses, and can radiate radio frequency energy, and if not installed and used in accordance with the instruction manual, may cause interference to radio communications. It has been tested and found to comply with the limits for a Class A computing device pursuant to Subpart J of Part 15 of Federal Communications Commission (FCC) Rules, which are designed to provide reasonable protection against such interference when operated in a commercial environment. Operation of this equipment in a residential area or modification to this equipment is likely to cause interference, in which case the user, at his own expense, will be required to take whatever measures may be required to correct the interference. If you suspect interference from an Atari game at your location, check the following:

- All ground wires in the game are properly connected as shown in the game wiring diagram.
- The power cord is properly plugged into a grounded three-wire outlet.
- On games provided with an Electromagnetic Interference (EMI) ground plane, be sure that the game printed-circuit boards (PCBs) are properly installed on the EMI ground plane and that the end board is securely installed with **all** screws in place and tightened.

If you are still unable to solve the interference problem, please contact Customer Service at Atari Games Corporation. See the inside front cover of this manual for service in your area.

S A F E T Y S U M M A R Y

The following safety precautions apply to all game operators and service personnel. Specific warnings and cautions will be found in this manual whenever they apply.

WARNING

Properly Ground the Game. Players may receive an electrical shock if this game is not properly grounded! To avoid electrical shock, do not plug in the game until it has been inspected and properly grounded. This game should only be plugged into a grounded three-wire outlet. If you have only a two-wire outlet, we recommend you hire a licensed electrician to install a three-wire grounded outlet. If the control panel is not properly grounded, players may receive an electrical shock! After servicing any part on the control panel, check that the grounding wire is firmly secured to the inside of the control panel. After you have checked this, lock up the game.

AC Power Connection. Before you plug in the game, be sure that the game's power supply can accept the AC line voltage in your location. The line voltage requirements are listed in the first chapter of this manual.

Disconnect Power During Repairs. To avoid electrical shock, disconnect the game from the AC power before removing or repairing any part of the game. If you remove or repair the video display, be very careful to avoid electrical shock. High voltages continue to exist even after power is disconnected in the display circuitry and the cathode-ray tube (CRT). Do not touch the internal parts of the display with your hands or with metal objects! Always discharge the high voltage from the CRT before servicing it. Do this after you disconnect it from the power source. First, attach one end of a large, well-insulated, 18-gauge jumper wire to ground. Then momentarily touch the free end of the grounded jumper wire to the CRT anode by sliding the wire under the anode cap. Wait two minutes and do this again.

Use Only Atari Parts. To maintain the safety of your Atari game, use only Atari parts when you repair it. Using non-Atari parts or modifying the game circuitry may be dangerous, and could injure you and your players.



Handle the CRT With Care. If you drop the CRT and it breaks, it may implode! Shattered glass from the implosion can fly six feet or more.

Use the Proper Fuses. To avoid electrical shock, use replacement fuses which are specified in the parts list for this game. Replacement fuses must match those replaced in fuse type, voltage rating, and current rating. In addition, the fuse cover must be in place during game operation.

CAUTION

Properly Attach All Connectors. Make sure that the connectors on each printed circuit board (PCB) are properly plugged in. The connectors are keyed to fit only one way. If they do not slip on easily, do not force them. If you reverse a connector, it may damage your game and void your warranty.

Ensure the Proper AC Line Frequency. Video games manufactured for operation on 60 Hz line power (used in the United States) must not be operated in countries with 50 Hz line power (used in Europe). If a 60 Hz machine operates on 50 Hz line power, the fluorescent line ballast transformer will overheat and cause a potential fire hazard. Check the product identification label on your machine for the line frequency required.

ABOUT NOTES, CAUTIONS, AND WARNINGS

In Atari publications, notes, cautions and warnings have the following meaning:

NOTE — A highlighted piece of information.

CAUTION — Equipment and/or parts can be damaged or destroyed if instructions are not followed. You will void the warranty on Atari printed-circuit boards, parts thereon, and video displays if equipment or parts are damaged or destroyed due to failure of following instructions.

WARNING — Players and/or technicians can be killed or injured if instructions are not followed.

CONTENTS

1 Installation

How to Use This Manual	1-1
Cabinet Equipment Requirements	1-2
Tools Required	1-6
Inspecting the Kit	1-6
Preparing the Cabinet for the Kit Installation	1-6
Assembling the Control Panel	1-7
Installing the Foot Pedal	1-8
Connecting the JAMMA Harness	1-8
Installing the Road Riot 4WD Board Set	1-9
Installing the Bezel, Decals, Labels, and Attraction Assembly	1-9
Setting the Coin and Game Options	1-10
Maximizing Earnings	1-10
Game Play	1-10

2 Self-Test

Introduction	2-1
Entering and Exiting the Self-Test	2-2
Self-Test Menu	2-2
Adjust Volume	2-2
Game Statistics	2-3
Histograms	2-3
Coin Options	2-3
Game Options	2-4
Alpha Test	2-4
Motion Object Test	2-4
Playfield Test	2-6
Switch Test	2-6

Color Test	2-6
Convergence Test	2-7
Sound Test	2-7
ASIC65 Test	2-7
DSP Comm Tests and DSP Link Tests	2-8
Complete RAM and ROM Test	2-8

3 Troubleshooting and Maintenance

Introduction	3-1
Video Display Sync Problems	3-3
Troubleshooting	3-3
Removing and Replacing the Steering Control	3-3
Removing and Replacing the Foot Pedal Assembly	3-4
ROMs and RAMs	3-4

4 Parts Illustrations

See the List of Illustrations that follows.

5 Schematic Diagrams

See the List of Illustrations that follows.

Glossary

Begins on page gl-1

Statistics Sheet

ILLUSTRATIONS

Figure 1-1 Installed Kit Parts..... 1-3
 Figure 1-2 Locations of Control Panel Holes to be Drilled..... 1-6
 Figure 1-3 Hole-Cutting Template for Road Riot 4WD Kit Control Panel..... 1-11
 Figure 1-4 Hole-Cutting Template for Road Riot 4WD Kit Foot Pedal..... 1-13

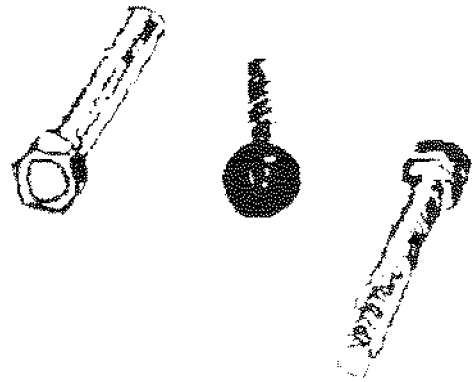
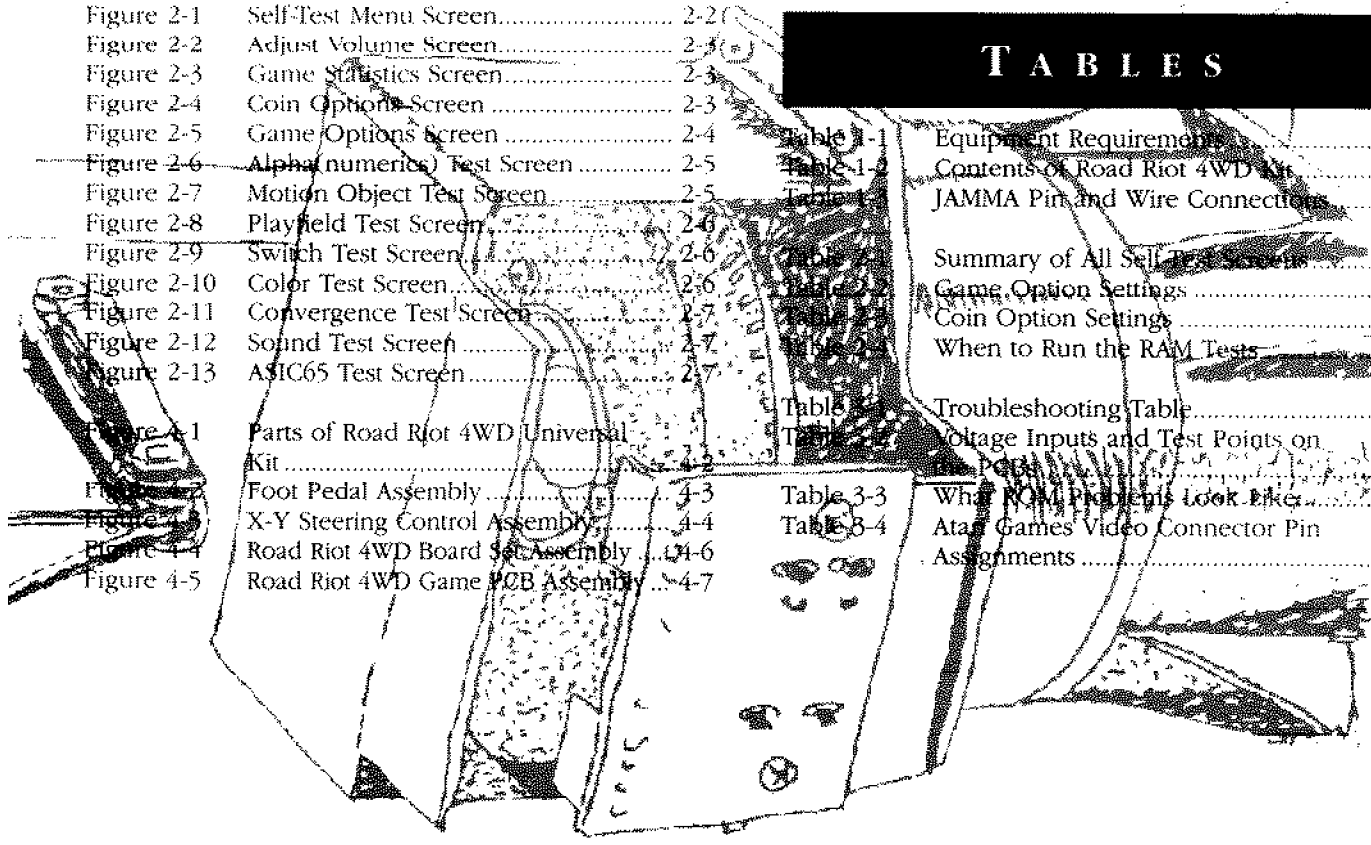
Figure 2-1 Self-Test Menu Screen..... 2-2
 Figure 2-2 Adjust Volume Screen..... 2-3
 Figure 2-3 Game Statistics Screen..... 2-3
 Figure 2-4 Coin Options Screen..... 2-3
 Figure 2-5 Game Options Screen..... 2-4
 Figure 2-6 Alpha (numeric) Test Screen..... 2-5
 Figure 2-7 Motion Object Test Screen..... 2-5
 Figure 2-8 Playfield Test Screen..... 2-6
 Figure 2-9 Switch Test Screen..... 2-6
 Figure 2-10 Color Test Screen..... 2-6
 Figure 2-11 Convergence Test Screen..... 2-7
 Figure 2-12 Sound Test Screen..... 2-7
 Figure 2-13 ASIC65 Test Screen..... 2-7

Figure 4-1 Parts of Road Riot 4WD Universal Kit..... 4-1
 Figure 4-2 Foot Pedal Assembly..... 4-3
 Figure 4-3 X-Y Steering Control Assembly..... 4-4
 Figure 4-4 Road Riot 4WD Board Set Assembly..... 4-6
 Figure 4-5 Road Riot 4WD Game PCB Assembly..... 4-7

Figure 4-6 JSA (JAMMA Stand-alone Audio) III PCB Assembly..... 4-8
 Figure 4-7 JAMMA Filter PCB Assembly..... 4-8
 Figure 5-1 Road Riot 4WD Game PCB Assembly Schematic Diagram..... 5-2
 Figure 5-2 JSA Audio III Assembly Schematic Diagram..... 5-8
 Figure 5-3 JAMMA Filter PCB Assembly Schematic Diagram..... 5-14

TABLES

Table 1-1 Equipment Requirements..... 1-2
 Table 1-2 Contents of Road Riot 4WD Kit..... 1-2
 Table 1-3 JAMMA Pin and Wire Connectors..... 1-4
 Table 2-1 Summary of All Self-Test Screens..... 2-2
 Table 2-2 Game Option Settings..... 2-4
 Table 2-3 Coin Option Settings..... 2-5
 Table 2-4 When to Run the RAM Tests..... 2-7
 Table 3-1 Troubleshooting Table..... 3-2
 Table 3-2 Voltage Inputs and Test Points on PCB..... 3-3
 Table 3-3 What ROM Problems Look Like..... 3-3
 Table 3-4 Atari Games Video Connector Pin Assignments..... 3-3



Installation

HOW TO USE THIS MANUAL

The Road Riot 4WD™ conversion kit is a one-player game for a standard upright cabinet. Included in the kit is a steering control and a foot pedal. ❖ For maximum earnings, two cabinets of the same style can be converted and linked together. To link two game cabinets together, you can order the Road Riot 4WD link kit with the necessary cable and other hardware (the link kit is Atari part no. A049867-01). Contact your distributor for details. A separate supplement included in the link kit, CO-373-01, describes how to install that link kit. ❖ This manual provides information for installing, testing, and troubleshooting the Road Riot 4WD™ conversion kit. ❖ Chapter 1 describes



how to install the Road Riot 4WD kit in your cabinet. This chapter also describes game play.

❖ Chapter 2 contains self-test procedures and additional diagnostic tests. The self-test is important in the Road Riot 4WD game. You can troubleshoot the PC boards, main circuits, and controls using the screens in the self-test. You should regularly test the boards and controls with the self-test to keep your game in peak condition and at top earnings. ❖ Chapter 3 contains troubleshooting and maintenance procedures for the controls. ❖ Chapter 4 contains the kit parts list and parts illustrations. ❖ Chapter 5 contains the schematics for the Road Riot 4WD printed-circuit boards.

WARNING

To avoid electrical shock, unplug the cabinet while installing the kit. After installation, plug the game only into a grounded 3-wire outlet.

Cabinet Equipment Requirements

Table 1-1 lists the equipment required in the cabinet into which you are installing the Road Riot 4WD kit.

CAUTION

Do not unplug or plug in the Road Riot 4WD game printed-circuit board (PCB) edge connector while the power is on. You could seriously damage the PCB.



Equipment	Specification
Video Display	Color RGB monitor Separate positive horizontal and vertical sync or negative composite sync Horizontal mounting Horizontal frequency: 15.750 KHz Vertical frequency: 60 Hz Video input: 1V to 3V peak-to-peak positive polarity
Control Panel	Metal only
Speaker	8 Ω, 10 W
Coin Counter	+5 VDC or +12 VDC
Power Cord	Three-conductor with ground
Power Supply	+5 VDC ± 0.25V @ 3.0 amps +12 VDC @ 1.0 amp -5 VDC @ 1.0 amp (optional)

Table 1-1 Equipment Requirements

Part No.	Description
72-1606F	#6-32 x 3/8"-Long Pan-Head, Cross-Recessed Screw
72-1612F	#6-32 x 3/4"-Long Pan-Head, Cross-Recessed Screws (3)
72-6608S	#6 x 1/2"-Long, Type AB, Pan-Head, Cross-Recessed Screws (2)
72-6624S	#6 x 1 1/2"-Long, Type AB, Pan-Head, Cross-Recessed Screws (2)
75-07002	#1/4 Fender Washers (8)
75-5112B	#10-24 x 3/4"-Long Black Carriage Bolts (4)
75-5512B	1/4-20 x 3/4"-Long Black Carriage Bolts (4)
175004-706	.154" x .375" x .125"-Thick Fiber Washers (8)
175014-1025	.156" x .312" Steel/Zinc Flat Washers (4)
175014-1040	#10 Flat Washers (4)
175014-1050	#1/4 Flat Washers (4)
175015-0113	#6 Steel/Cadmium External-Tooth Lock Washers (4)
176038-4412	#1/4-20 x .75" Tamper-Proof Flush Countersunk Cap Screws (4)
177010-244	#1/4-20 Hex Polymer Locknuts (8)
177026-0040	#10-24 Zinc Nut/Washer Assemblies (4)
178020-812	#6, I.D. .140", O.D. .25", L .812" Nylon RWD Spacers (2)
178032-002	#10 Wire & Cable Tie
178126-002	5/32" Tamper-Proof Hex Driver Key
178328-001	Tamper-Proof T-20 TORX Key
178328-002	Tamper-Proof T-10 TORX Key
038158-01	Product I.D. Label
039450-01	FCC Compliance Label
047205-01	Attraction Shield
047209-01	Control Panel Cover
047853-01	Control Mounting Bracket
049319-02	Red Steering Control Decal
049774-01	Black Monitor Bezel
049775-01	Attraction Panel Film
049776-01	Side Panel Decals (2)
049777-01	Control Panel Decal
049866-01	PCB Ground Plane and Mounting Plate
049970-01	Game Instructions Label for Control Panel
141026-001	.5"-I.D. Ferrite Split Beads (2)
160060-002	6.3V Square Green Start Button Assembly with Lamp
A043825-02	Foot Pedal Assembly
A046501-01	JAMMA Harness Assembly (optional)
A047964-01	Interconnect Control Harness Assembly
A049292-01	JAMMA Filter Board Assembly
A049454-03	Non-Shaker Steering Assembly
A049813-01	Road Riot 4WD PC Board Set
TM-373	Road Riot 4WD Universal Kit Installation Instructions (with control panel templates)
A049867-01	Link Kit for Road Riot 4WD kit (optional)

Packaging materials are not listed. All parts are a quantity of 1, except as noted in parentheses.

Table 1-2 Contents of Road Riot 4WD Kit

NOTE

The parts in the optional link kit are not shown in this illustration. See the supplement to this manual (CG-373-01) for a list of the parts supplied in that kit and how to install them.

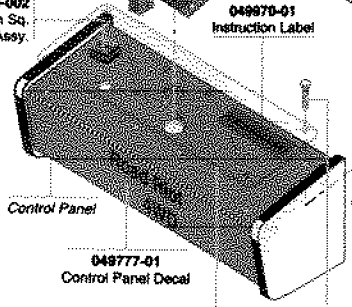
Items Not Shown:

- | | |
|--|--|
| A047964-01
Control Interconnect
Harness Assy | 038158-01
Product I.D. Label |
| 141028-001
Ferrite Bead
(2 places) | 039450-01
FCC Compliance Label |
| 178328-001
T-20 Tamper-proof TORX Key | 178126-002
5/32" Tamper-Proof Hex Key Driver |
| 178328-002
T-10 Tamper-proof TORX Key | 179032-002
#10-24 Wire & Cable Tie |
| | TM-373
Road Riot 4WD Universal Kit
Installation Instructions |

- 047853-01
Control Mounting Bracket
175014-1090
#1/4 Flat Washer
(4 places)
177010-244
#1/4-20 Polymer Hex Locknut
(4 places)
75-5512B
#1/4-20 x 3/4" Carriage Bolt
(4 places)

- A048454-03
Steering Control
Assy. (w/o shaker)
- 049319-02
Red Steering Control Decal
75-07002
#1/4 Fender Washer
(4 places)
177010-244
#1/4-20 Polymer Hex Locknut
(4 places)
176038-4412
#1/4-20 Countersunk Screw
(4 places)

- 160060-002
Green Sq.
Button Assy.



Control panel in closed position

- 049774-01
Black Bezel
- 047209-01
Attraction Shield
- 048775-01
Attraction Film

- 048775-01
Side Panel Decal
(2 places)

- A048613-01
Road Riot 4WD Board Set
- 049666-01
PCB Ground Plane
and Mounting Plate
72-6612F
#6-32 x 3/4"
Pan-Hd Screw
(3 places)
175004-706
Fiber Washer
(2 places)
175014-1025
#6 Flat Washer
(4 places)
A047292-01
JAMMA Filter Board Assy.
176020-612
Spacer
(2 places)
72-6624S
#6 x 1 1/2" Screw
(2 places)
175015-0113
#6 Lock Washer
(4 places)
72-1606F
#6-32 x 3/8" Screw

- 175014-1040
Flat Washer
(4 places)
177026-0040
#10-24 Nu/Washer Assy.
(4 places)

- 75-5112B
#10-24 x 3/4" Carriage Bolt
(4 places)

- A043825-02
Foot Pedal Assy.
177010-244
#1/4-20 Polymer
Hex Locknut
(4 places)
75-07002
1/4 Fender Washer
(4 places)

Figure 1-1 Installed Kit Parts

Pin	Signal	Instructions
Component Side		
1	RTN	Connect to the 5V RTN terminal on the power supply. However, if you have 12V RTN, connect <i>one</i> of the wires at pin 1, 2, A, or B to the 12V RTN terminal.
2	RTN	Same as pin 1.
3	+5V	Connect to the +5V terminal on the power supply.
4	+5V	Connect to the +5V terminal on the power supply. However, if your power supply has a + Sense terminal, connect to the + Sense.
5	-5V	Connect to the -5V terminal of the power supply. If -5V is not available, connect to the 12V RTN or the 5V RTN or leave it unconnected. <i>NOTE: If you do not have (or use) -5V, the maximum power to the speaker will be reduced by half.</i>
6	+12V	Connect to the +12V terminal of the power supply. If your coin counter(s) require 12V, also connect to the + side of the coin counter(s).
7	Key	
8	COIN CTR 1	Connect this wire to one side of the left 12V coin counter. <i>Note: Do not use 24V counters.</i> Connect the + side to +5V or +12V on the power supply, as appropriate.
9	Not used	
10	SPKR +	Connect to the + terminal on the speaker.
11	Not used	
12	RED	Attach to the video display.
13	BLUE	Attach to the video display.
14	VIDEO GND	Attach to the video display.
15	SELF-TEST	Use this wire if you want an external self-test switch. However, the kit already has a self-test switch on the PCB. <i>(If you connect an external self-test switch, switch off the switch on the PCB. Connect the wire to the N.O. terminal on the external self-test switch. Connect the common terminal of the switch to a GND wire.)</i>
16	LT COIN	Connect to the N.O. terminal of the left coin switch. Connect the common terminal of the switch to a wire.
17	START1	Connect to the N.O. terminal of the start switch. Connect the common terminal to a GND wire.
18	GAS	Connect to the white wire of the foot pedal harness.
19	STEER	Connect to the Y/R wire in position 6 of the Control Interconnect Harness.
20	Not used	
21	Not used	
22	RT TRIGGER	Connect to the W/BN wire in position 2 of the Control Interconnect Harness.
23	LT TRIGGER	Connect to the W/R wire in position 1 of the Control Interconnect Harness.
24	Not used	
25	Not used	
26	Not used	
27	GND	Connect to the BK wires in positions 10 and 11 of the Control Interconnect Harness.
28	GND	Connect to the negative sense terminal of the power supply (if it exists); otherwise connect to the common terminals of the switches.

Table 1-3 JAMMA Pin and Wire Connections

Pin	Signal	Instructions
Solder Side		
A	RTN	Connect to the 5V RTN terminal on the power supply. However, if you have 12V RTN, connect <i>one</i> of the wires at pin 1, 2, A, or B to the 12V RTN terminal.
B	RTN	Same as pin A.
C	+5V	Connect the +5V terminal on the power supply.
D	+5V	Connect to the red wire in position 9 of the Control Interconnect Harness and to the red wire in the foot pedal harness.
E	-5V	Connect to the -5V terminal of the power supply. If -5V is not available, connect to the 12V RTN or the 5V RTN (GND) or leave it unconnected. <i>NOTE: If you do not have (or use) -5V, the maximum power to the speaker will be reduced by half.</i>
F	+12V	Connect to the +12V terminal of the power supply.
H	Key	
J	COIN CTR 2	Connect this wire to one side of the right 12V coin counter. Clip R19 on the game PCB if you use a second coin counter. <i>Note: Do not use 24V counters.</i> Connect the + side to +5V or +12V on the power supply, as appropriate.
K	Not used	
L	SPKR-	Connect to the - terminal on the speaker.
M	Not used	
N	GREEN	Attach to the video display.
P	COMPSYNC	Attach to the video display.
R	Service 1	Optional: attach to the N.O. terminal of the 1st or main service switch.
S	Not used	
T	RT COIN	Connect to the N.O. terminal of the right coin switch. Connect the common terminal of the switch to a GND wire.
U	Not used	
V	Not used	
W	Not used	
X	Not used	
Y	Not used	
Z	Not used	
a	Not used	
b	Not used	
c	Not used	
d	Not used	
e	GND	Connect to the BK wire of the foot pedal harness.
f	GND	Connect to the common terminal of the switches.

NOTE

The lamp in the square start button is *not* used in this kit version of Road Riot 4WD. Therefore, no wire connections to the lamp are shown in this table.

Table 1-3 JAMMA Pin and Wire Connections, Continued

Tools Required

- Drill with a 1/2-inch and 5/16-inch drill bits
- Phillips screwdriver
- Flat-blade screwdriver
- Socket wrench set and ratchet
- 5/32" hex wrench
- Wire cutters and strippers
- Straight edge
- Squeegee
- X-ACTO™ knife
- Insulated wire connectors (if you are installing a new JAMMA harness)
- Carbon paper
- Saber saw
- File
- Bandsaw
- Tape or glue

Inspecting the Kit

Check to see that you have all the parts listed in the kit parts list in Table 1-2. If any part is missing or damaged, contact your distributor with the Road Riot 4WD kit serial number, part number, and description of the missing or damaged parts, and date received.

Preparing the Cabinet for the Kit Installation

WARNING

To avoid electrical shock, unplug the cabinet while installing the kit. After installation, plug the game only into a grounded 3-wire outlet.

Figure 1-1 shows almost all kit parts installed in a typical cabinet. Use this illustration as a guide while you install the parts.

1. Turn off power to the game, and unplug the power cord.

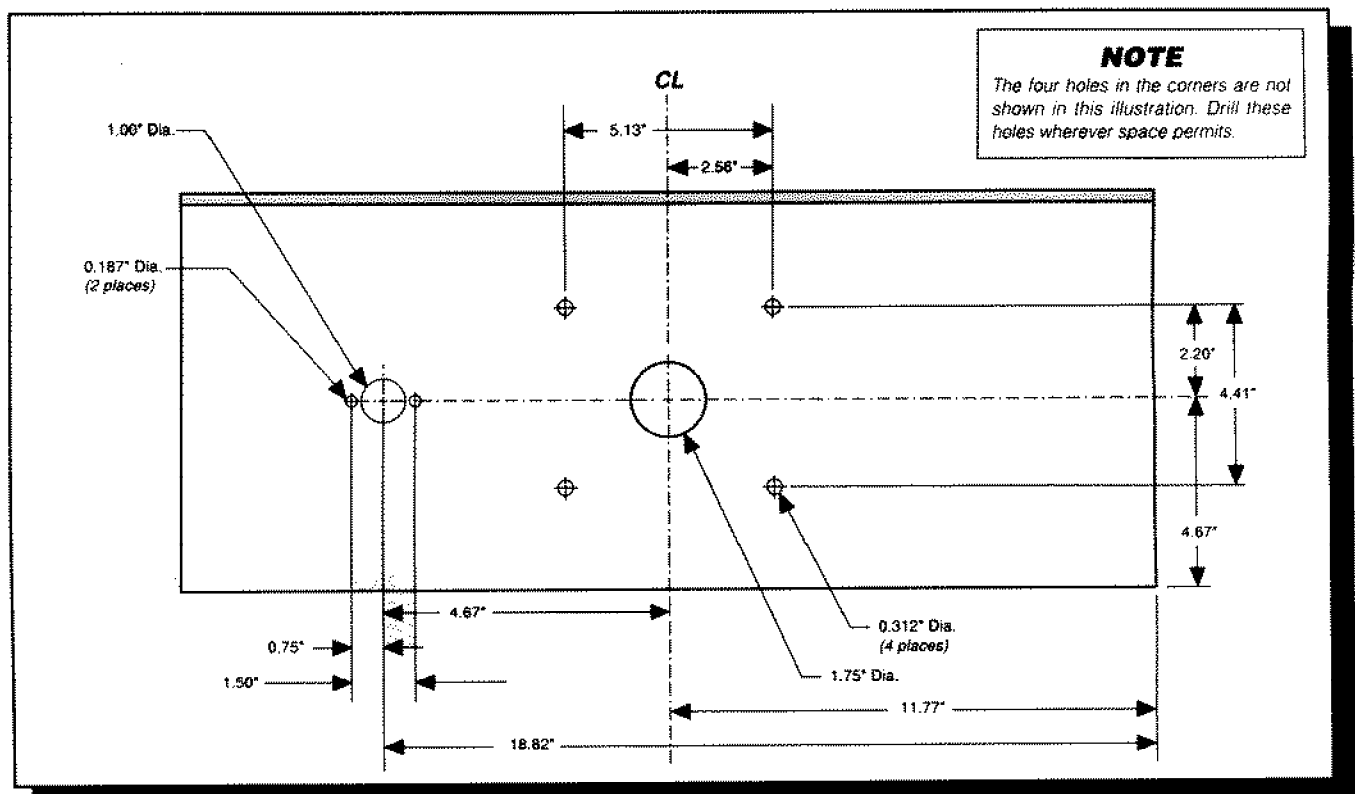


Figure 1-2 Locations of Control Panel Holes to be Drilled

2. Remove the following from the cabinet:
 - Existing PCBs
 - Game harness, if it is not Japan Amusement Machinery Manufacturers Association (JAMMA)-compatible. Table 1-3 on the previous two pages assumes you have an available game cabinet with a JAMMA harness installed in it.
 - Control panel decals, labels, and controls
 - Side decals, graphics, and adhesive. If the cabinet sides are damaged, repair them before putting on the new decals.
 - Video display (monitor) shield, display bezel, attraction shield, and marquee.
3. Wipe down and vacuum the cabinet. Paint the cabinet, if required:

Assembling the Control Panel

Parts Needed from this Kit

To assemble the control panel, you need the control panel hole-cutting template, which is printed in Figure 1-3. Cut out the template sheet from this manual. You will also need the following parts from the kit:

- Clear cover for the control panel
- Control panel decal
- Green START button assembly
- Red steering control decal
- Control mounting bracket
- Game instructions label
- Steering control
- Four # $\frac{1}{4}$ -24 x $\frac{3}{8}$ "-long black carriage bolts, flat washers, and nut/washer assemblies for the steering control
- Four #10-24 x $\frac{1}{2}$ "-long black carriage bolts, flat washers, and nut/washer assemblies for the corners of the control panel cover

Installing the Parts

1. Using carbon paper, transfer the steering control mounting pattern from the template to the control panel. Save the template. Also refer to Figure 1-2 or 1-3 for the exact locations of all control-panel holes.
2. Drill four $\frac{3}{8}$ " holes in the metal control panel for the steering control mounting bolts.
3. Drill two $\frac{1}{2}$ " holes in the metal control panel for the start button's mounting screws.

4. Using a saber saw, carefully cut out the large hole for the steering control and the smaller hole for the start button. Deburr the sharp edges with a file.
5. Lay the plexiglass cover over the top of the control panel and mark the outside shape of the panel on the plastic. Also mark the button holes as close as possible to the locations shown on the template.

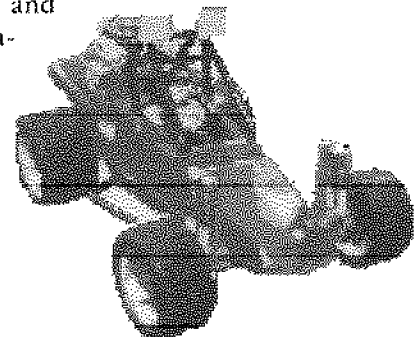
Lastly, mark the positions of the four holes that will be used for securing the cover to the control panel. These four holes can be placed anywhere near the corners—wherever space permits.
6. Using a handsaw, cut the control panel cover to its correct outside shape.

WARNING

Wear safety glasses when drilling the plastic control panel cover. Use care to avoid shattering or chipping the plastic.

7. Tape or glue the template to the plexiglass cover. To start the saber saw cut, drill a $\frac{1}{2}$ " hole inside the steering control hole and the start button hole.
8. Saw out the large steering control hole and the start button hole.
9. Drill the four $\frac{3}{8}$ " holes that will be used to mount the cover to the control panel and the holes to mount the steering control and start button.
10. To prevent injury, carefully deburr all the edges of the plexiglass cover.
11. Install the control panel decal on the control panel. Use a sharp X-ACTO knife to trim the outside edge and to cut out the holes for the controls. Mount the instruction decal on the control panel.
12. Install the cover on the control panel with the four $\frac{3}{4}$ "-long carriage bolts, washers, and locknuts.
13. Install the steering control using the $\frac{3}{4}$ "-long carriage bolts and # $\frac{1}{4}$ -20 nut/washer assemblies.
14. Install the start button assembly as shown in Figure 1-1.

For maintenance and servicing information on the steering control, refer to Chapter 3 of this manual.



Installing the Foot Pedal

Parts Needed from this Kit

To install the foot pedal, you need the foot pedal hole-cutting template (see Figure 1-4 at the end of this chapter). Cut out the template sheet from this manual. You will also need the following parts from the kit:

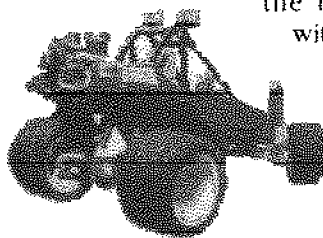
- Foot pedal assembly
- Four fender washers and locknuts

Installing the Parts

1. Tape the foot pedal template to the lower right corner on the front of the game cabinet (see Figure 1-1 for general placement). Refer to Figure 1-4 for the exact location of the foot-pedal holes. Using carbon paper, transfer the foot pedal mounting pattern from the template to the cabinet. Save the template.
2. Drill four $\frac{7}{16}$ " corner holes and a $1\frac{1}{2}$ " center hole in the cabinet front.
3. Feed the pedal harness through the large center hole. Insert the foot pedal's threaded studs into the four small corner holes.
4. From the inside of the cabinet, install the four fender washers and locknuts onto the threaded studs of the pedal. Plug in the pedal harness connector.

Connecting the JAMMA Harness

1. If your game cabinet does not already have a JAMMA harness, install a JAMMA harness in the cabinet (optional, Atari part no. A046501-01).
2. Install the square split beads on the harness as close to the PCB edge connector as possible. Hold the beads on the harness with the tie wrap included in the kit.



CAUTION

You must install the JAMMA filter board and the split beads on the JAMMA harness to meet FCC requirements.

3. Using Table 1-3 for wiring information, connect the JAMMA harness to existing component harnesses. Use crimp splices or butt soldering.
-

WARNING

Do not simply tie the wires together. If you do, you could cause intermittent problems, loose connections, oxidation, or a fire.

Connecting Power Wires

1. Connect the wires on the JAMMA harness to the wires for the power supply, as shown in Table 1-3. The Road Riot 4WD kit requires +5V and +12V. If -5V is available, it should be used, too. Tie off any other voltage wires on the power supply besides +5V, -5V, and +12V.

There is more than one wire for each voltage in the JAMMA harness. Use more than one wire for each voltage (connecting them as described in Table 1-3) so that the power wiring does not overload and burn.

Connecting Video Display Wires

NOTE

The JAMMA harness provides only negative composite sync. If your video display requires separate positive sync, see Chapter 3 for alternative wiring.

Connect the wires designated for the red, green and blue video guns along with the sync and ground wires, according to Table 1-3.

Connecting Coin Door Wires

1. Connect the wires on the JAMMA harness to the coin switches and meter according to Table 1-3.
2. Connect one terminal of the door lamps to one of the GND wires. Connect the other terminal of the door lamps to the R wire supplying +5V.

NOTE

*Do not use -5V for the coin door lamps.
-5V is required for audio.*

Some games have separate power supply outputs for the coin door lamps. If you choose to use these outputs, make sure you connect both terminals of each lamp to the terminals on the power supply.

Connecting the Control Wires

Connect the steering control harness and the start button harness to the JAMMA harness using crimp splices or butt soldering, according to the information in Table 1-3.

Grounding the Cabinet

Find the ground lead (green) of the 115V input power line. Connect this lead in daisy-chain fashion to a bare metal part of the coin door, the control panel, the video display, and the power supply. This AC ground must be of #18 AWG wire or larger.

WARNING

For the safety of players, you must connect the green ground wire as indicated above.

Checking the JAMMA Connections

Before plugging in the game PCB, turn on the power to the game, and check +5 Volts on pins 3, 4, C, and D of the JAMMA connector; +12 Volts on pins F and 6; and -5 Volts on pins E and 5.

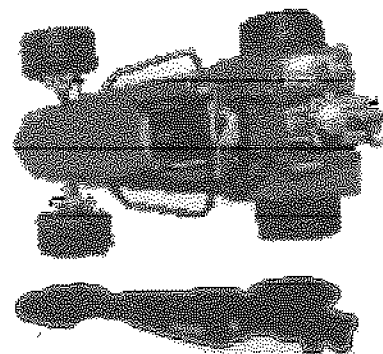
Check that the video display and the attraction lamp have power. Now turn off the power to the game.

Installing the Road Riot 4WD Board Set

After you have checked the power on the JAMMA connector (above), install the Road Riot 4WD board set in the cabinet, by following these steps and referring to Figure 4-4:

1. Use the three #6-32 x $\frac{3}{8}$ " long screws to connect the game PCB to the PCB ground plane and mounting plate.
2. Plug the JAMMA filter board onto the front of the game PCB, and mount it to the ground plane using one #6-32 x $\frac{3}{8}$ " screw provided in the kit.

3. Use two #6 x $\frac{1}{2}$ " screws and the two #6 x $\frac{1}{8}$ " spacers to connect the game PCB into the back side of the drawer.
4. Then, use the two #6 x $\frac{1}{2}$ " screws to mount the mounting plate into the front of the drawer.
5. Plug the JAMMA harness into the filter board. Secure the JAMMA harness away from the PCB with cable ties.
6. Turn on the power to the game. Check that the game PCBs function. If a video picture is not present, see Chapter 3.

**Installing the Bezel, Decals, Labels, and Attraction Assembly**

The bezel, decals, labels, and attraction assembly are shown assembled in a cabinet in Figure 1-1.

Installing the Display Bezel

Find the black cardboard display bezel in the kit. This bezel can accommodate both 19-inch and 25-inch video displays. Follow the instructions on the back of the bezel, and cut the hole and outside edges as required.

Installing the Product ID and FCC Label

Place the product ID label (part no. 038158-01) and FCC compliance label (part no. 039450-01) on the back of the cabinet.

Installing the Side Panel Decals

Find the side panel decals in the kit. Wet the left and right side panels of the cabinet with slightly soapy water. Then position the decals as shown in Figure 1-1. Remove any wrinkles in the artwork using a squeegee. Allow the sides to dry.

Installing the Attraction Assembly

Find the Road Riot 4WD attraction shield and the attraction panel film in the kit. Using the existing shield as a template, cut the shield and film to size, if necessary. Install them on the cabinet as shown in Figure 1-1.

Setting the Coin and Game Options

Set the coin and game options in the self-test. See Chapter 2 for information about the option settings. If you have linked two game cabinets together, you *must* set both players to the same difficulty setting, or the game will not function properly after turning on the power. If the settings don't agree, you can change them both to medium by pressing both start buttons at power-up. You can also use the Game Options screen in the self-test to change the setting.

NOTE

The factory-recommended coin option setting for "Discount to Continue" should be set to Yes (see Table 2-3 in this manual). Making your game match all the recommended settings results in a setting of 2 coins to start/1 to continue.

We highly recommend this increase in price per play, to maximize your return on investment. However, this setting may not suit all locations.

Maximizing Earnings

For maximum earnings, regularly maintain your Road Riot 4WD game following the instructions in Table 3-1, in Chapter 3.

When you set up the game and when you collect money, perform the automated self-test and check the controls with the Switch Test in the self-test.

Game Play

This section describes the features and driving of the Road Riot 4WD™ game.

Introduction

Road Riot 4WD presents off-road racing competition combined with combative shooting action. Players drive high-performance off-road vehicles armed with a stun gun.

Game Play

Road Riot 4WD is a one-player off-road racing game kit where players can compete for an overall season championship.

Controls in this game include a start button, a gas pedal, and a steering control with trigger buttons.

Players are challenged by the lifelike skidding and bouncing action of their four-wheel-drive vehicles on the track. The cars can also crash in several different ways, depending upon how an object is hit. The cars can roll on their sides, fly end over end, or even explode on impact.

Twelve different tracks offer special terrain and competitor challenges. Each track has a different background, ranging from desert to mountains, corn fields to ice fields. Terrain and track obstacles vary for each setting.

Video graphics are digitized pictures of real-life objects. The Road Riot 4WD racing vehicles, people, and obstacles on and around the track are realistically depicted. The life-like detail and humorous interaction with the video graphics enhances player appeal.

Two-Player Linked Game Play

Two games can be converted and linked together via the optional link kit assembly (available from your distributor). The linked configuration encourages two-player competition; players can also choose to play individually.

If two games are linked, there are several incentives for two-player simultaneous play. Two players can compete head-to-head against each other for the season championship of 11 different race courses. The road riot will continue as long as the player defeats the hosting opponent's yellow cars. If two players are playing a linked game, there is one less computer-controlled car to beat. Two players can cooperate to beat the opponent cars.

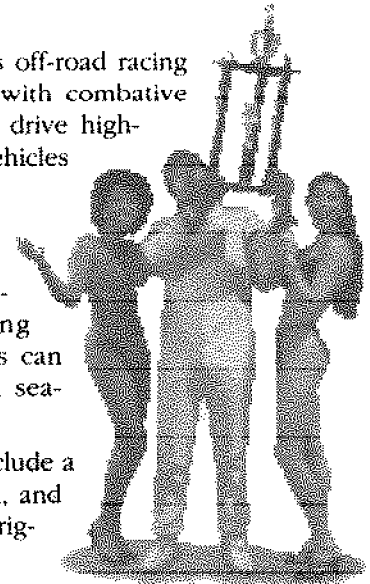
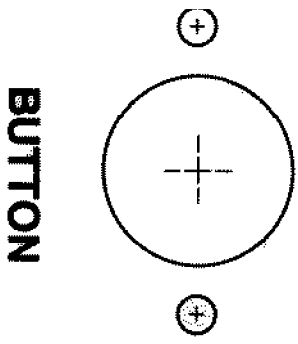
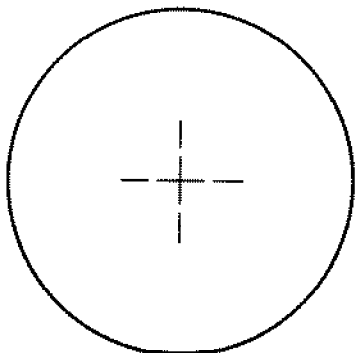


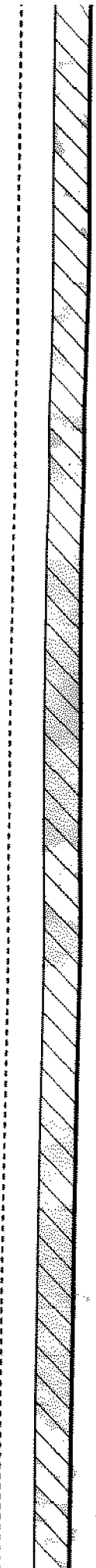
Figure 1-3 Hole-Cutting Template for Road Riot 4WD™ Kit Control Panel



BUTTON



X-Y STEERING CONTROL



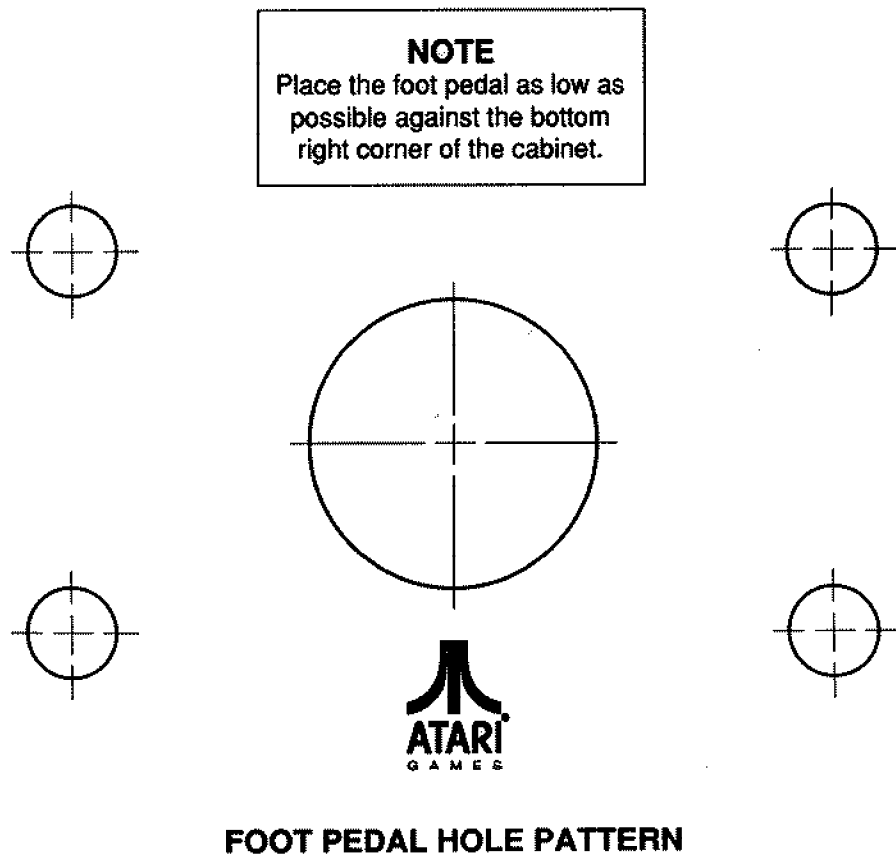
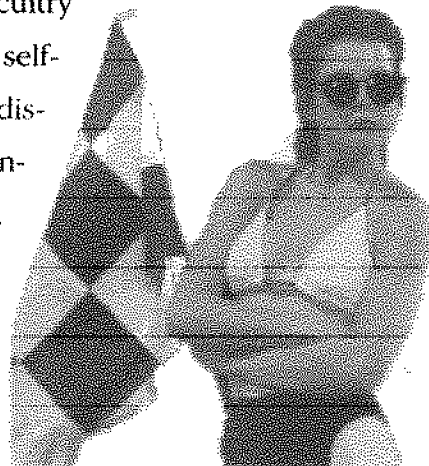


Figure 1-4 Hole-Cutting Template for Road Riot 4WD™ Kit Foot Pedal

Self-Test

INTRODUCTION

Use the Road Riot 4WD™ self-test to check the condition of the game circuitry and controls. You will see the self-test information on the video display and hear the sound test information through the speakers. You do not need any additional equipment to perform the self-test. ♦ You should perform the self-test when you



first set up the game, each time you collect the money, or when you suspect game failure. ♦ This chapter shows the screens in the self-test and explains each of the tests. The screens and explanations are arranged in the order they appear in the self-test. Table 2-1 lists all of the self-test screens and their purposes.

Entering and Exiting the Self-Test

To enter the self-test, turn on the self-test switch on the bracket located inside the coin door (if you wired your kit that way). The JSA III Audio PCB also has a self-test switch on it. These two switches are wired in parallel, meaning that you can use either one independently. Exit the self-test by switching off any of the self-test switches.

Self-Test Menu

Choose which test or screen you want to see from this menu, shown in Figure 2-1. Move up and down the list by pressing the left and right triggers; the corresponding test is highlighted in blue. Choose the screen by pressing the START button.

Adjust Volume

Adjust the volume of the game using this screen, shown in Figure 2-2. Control the volume by pressing the left and right triggers; the volume number increases or decreases. To restore the old volume level, push

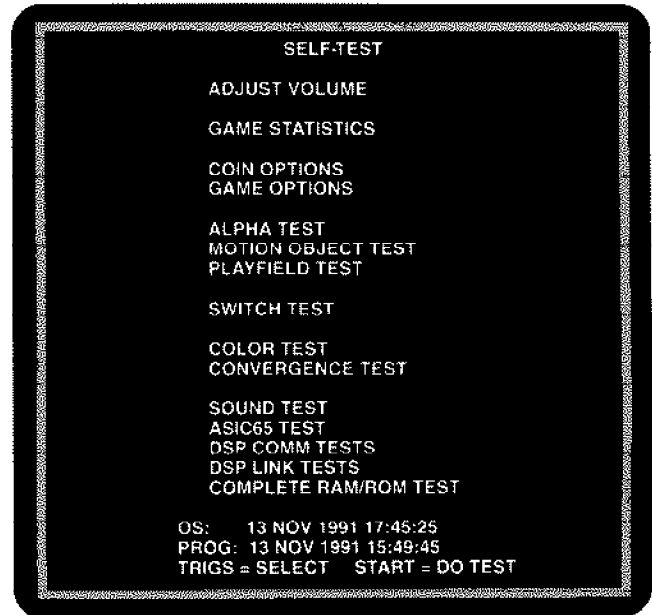


Figure 2-1 Self-Test Menu Screen

the gas pedal. Save the new volume and return to the self-test menu by pressing the START button.

Screen	Use or Purpose
Adjust Volume	Adjusts the volume.
Game Statistics Screen	Displays the game statistics.
Coin Options Screen	Use to set and check the coin options settings.
Game Options Screen	Use to set and check the game options settings.
Alpha Test Screen	Use to test for clarity of characters.
Motion Object Test Screen	Use to test the movement and color of game objects.
Playfield Test Screen	Use to check the playfield displays.
Switch Test Screen	Use to display the functioning of the game switches and controls.
Color Test Screen	Use to check the video display color circuits.
Convergence Test Screen	A series of screens to check and adjust display convergence.
White Convergence Screen	Use to check and adjust video display convergence of red, blue, and green.
Violet Convergence Screen	Use to check and adjust video display convergence of red to blue.
Green Convergence Screen	Use to check and adjust video display convergence of red and blue to green.
Sound Test Screen	Use to check the audio circuits.
ASIC65 Test Screen	Use to test comm port, checksum, and internal RAM.
DSP Comm Tests Screen	Use to check the communications hardware (works only if you have installed the optional link kit).
DSP Link Test	Use to test the transmitting and receiving of data between two linked games (works only if you have installed the optional link kit).
Complete RAM/ROM Test Screen	Use to check the all RAMs and program ROMs.

Table 2-1 Summary of All Self-Test Screens

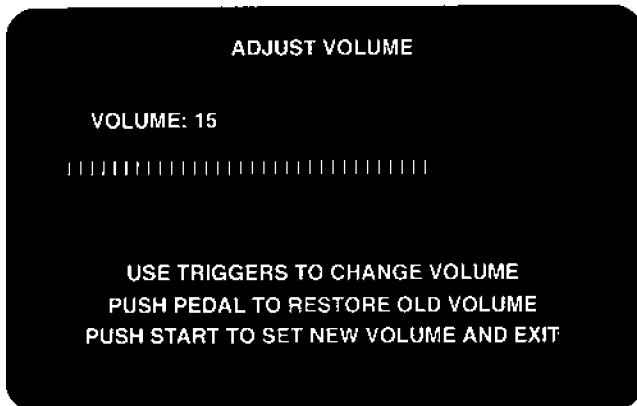


Figure 2-2 Adjust Volume Screen

Game Statistics

Use the information shown on the statistics screen, in Figure 2-3, and on the histogram screens to keep track of your game use and maximize your profits. Record the information on the Road Riot 4WD statistics page in the back of this manual. The statistics are collected from the last time the statistics were cleared. You can clear the statistics by pressing both triggers at the same time. Press the START button to leave this screen and go to the histograms.

- *Left Coins* show the number of coins counted in the left coin mechanism.
- *Right Coins* show the number of coins counted in the right coin mechanism.
- *Aux Coins* shows the number of coins counted on the auxiliary coin input.
- *New Games* is the number of new games played.



Figure 2-3 Game Statistics Screen

- *Continuation* is the number of continued games played.
- *Free Games* is the number of free games played if *Coin Options* is set to free games.
- *Idle Time* shows the number of minutes the game was not being played.
- *Active Time* is the number of minutes the game was being played in any mode.
- *Solo Time* is the number of minutes a race was being held in single-player mode.
- *Linked Time* is the number of minutes a race was being held in two-player mode.
- *Error Count* shows the number of errors counted in the erasable memory. If you have an error count, the statistics may be wrong. If you consistently have errors counted for several weeks, replace the EEROM at 38F.

Histograms

The histograms are two screens that contain information about the game. Press the START button to move to the next histogram. To clear all histograms, press both triggers while displaying the last histogram screen. Press START to exit from the last screen.

The first histogram shows new game times, and the second has continued game times.

Coin Options

Check and select the coin options on this screen, shown in Figure 2-4.

To move through the options, use the right trigger. Change the option in yellow type. The factory default

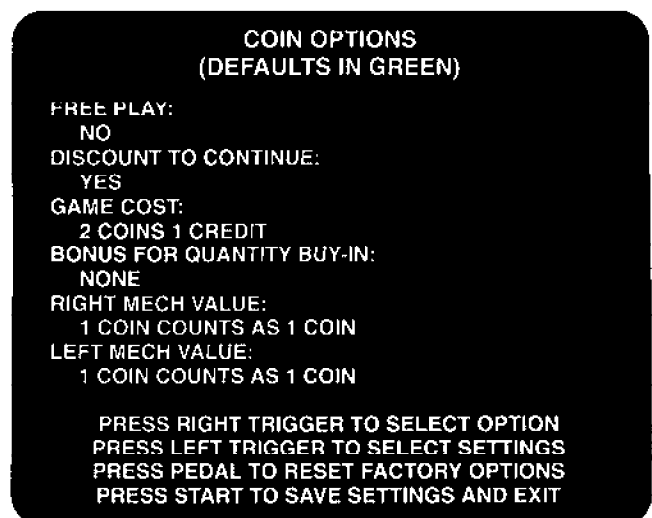


Figure 2-4 Coin Options Screen

Option	Settings	Explanation
Difficulty Level*	Medium ✓ Easy Easier Easiest Hardest Harder Hard Medium Hard	Establishes degree of game difficulty.
Car Color	Red ✓ Blue	Lets you display each player's car in a different color (used only in a linked, two-game setup).
Music in Attract	Yes ✓ No	Lets you choose whether or not to play music in the attract mode.
Clear High Score Table	Yes No ✓	Lets you clear the high score table.
Auto High Score Reset	Enable ✓ Disable	Automatically resets the high scores to the factory defaults after 2000 games, unless a player has entered his initials within the previous 200 games.

*If you have linked two games together, you **must** set both players to the same difficulty setting or the game will not function properly after turning on the power. If the settings don't agree, you can change them both to medium by pressing both START buttons at power-up. You can also use the Game Options screen in the self-test to change the setting.

✓ Manufacturer's recommended settings. These settings are shown in green on the screen.

Table 2-2 Game Option Settings

settings are shown in green. To change a setting, use the left trigger. To save the new settings, press the START button. This returns you to the select test screen. If you want to keep the original setting, although you have changed it, press the pedal. This brings back the original factory setting. Use the START button to exit.

The coin option settings and factory defaults are explained in Table 2-3.

Game Options

Check and select the game options on this screen, shown in Figure 2-5.

To move through the options, use the right trigger. Change the option in yellow type. The factory default settings are shown in green. To change a setting, press the left trigger. To save the new settings, press the START button. This returns you to the select test screen. If you want to keep the original setting, although you have changed it, press the pedal. This brings back the original setting. Use the START button to exit.

The game option settings with factory defaults are shown in Table 2-2.

Alpha Test

The alpha test consists of a series of screens that you use to test the clarity of characters. Figure 2-6 shows the first of the alpha test screens.

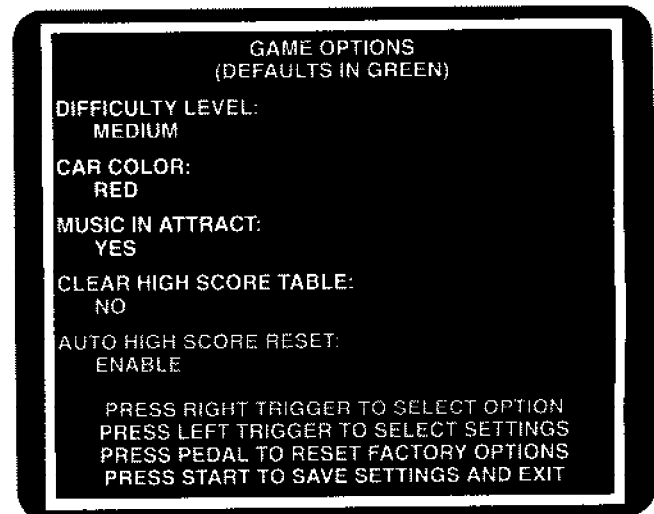


Figure 2-5 Game Options Screen

The screens display all of the alphanumeric character sets. If the screens are not clear, you have a problem. To move through the screens, press either the left or right trigger. Use the START button to exit.

Motion Object Test

The motion object test screen, shown in Figure 2-7, tests the movement and color of various game objects.

Select the test function with the START button. Use the pedal or steering control to move objects, change pictures, and change object size. Press the START button to move to the next test or exit.

Option	Settings	Explanation
Free Play	No ✓ Yes	Set this to "Yes" for demonstrating the game.
Discount to Continue	No Yes ✓	Lets you offer a reduced price per credit when players want to continue a game.
Game Cost	2 coins 1 credit ✓ ... 8 coins 1 credit	Sets the number of coins required for one credit.
Bonus for Quantity Buy-in	None ✓ 2 coins give 1 (extra coin) 3 coins give 1 3 coins give 2 4 coins give 1 4 coins give 2 4 coins give 3 5 coins give 1 5 coins give 2 5 coins give 3 6 coins give 1 6 coins give 2 6 coins give 3 7 coins give 1 7 coins give 2 7 coins give 3 8 coins give 1 8 coins give 2 8 coins give 3 9 coins give 1 9 coins give 2 9 coins give 3	Lets you choose various levels of bonus coins or no bonus.
Right Mech Value	1 coin counts as 1 coin ✓ ... 1 coin count as 8 coins	Is the number of coins each coin counts as in the right coin mechanism.
Left Mech Value	1 coin counts as 1 coin ✓ ... 1 coin count as 8 coins	Is the number of coins each coin counts as in the left coin mechanism.

✓ Manufacturer's recommended settings. These settings are shown in green on the screen.

Table 2-3 Coin Option Settings

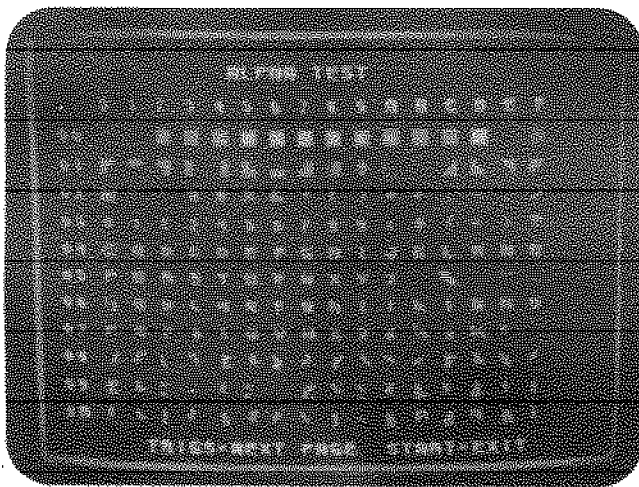


Figure 2-6 Alpha Test Screen

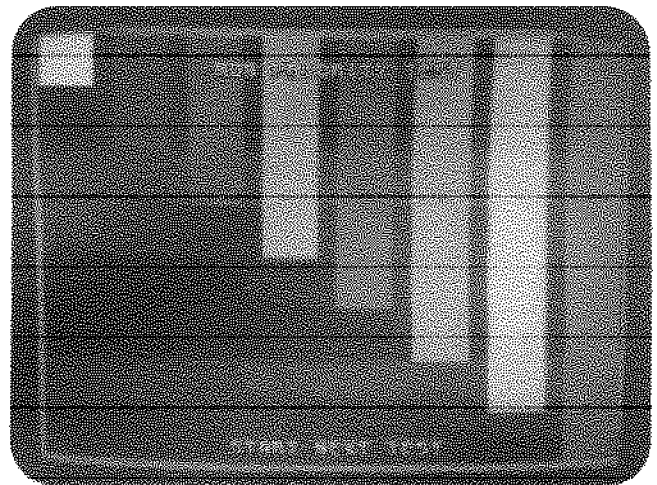


Figure 2-7 Motion Object Test Screen

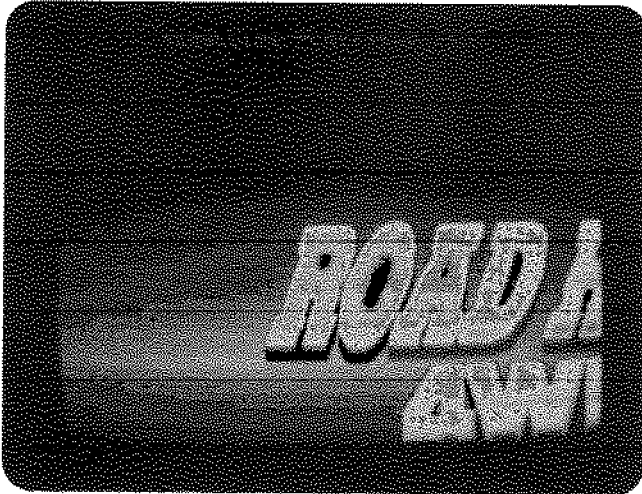


Figure 2-8 Playfield Test Screen

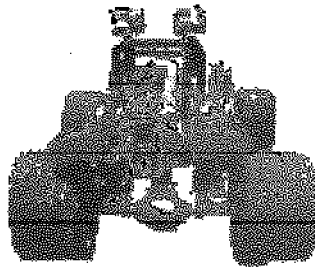
Playfield Test

This test, shown in Figure 2-8, checks the condition of the scrolling playfield. Move the steering control left/right to see horizontal movement on the screen. Hold the right trigger button while moving the control left/right to see vertical movement. Press the START button to exit the test.

Switch Test

The switch test allows you to display the status of the game switches and controls. The switch test screen appears in Figure 2-9. The items tested are:

- Steering wheel left/right movement
- Foot pedal potentiometer
- Left trigger switch
- Right trigger switch
- Start switch and start lamp



As you activate each switch or control, make sure the correct words are highlighted in blue on the screen.

If players complain of cars driving erratically, or whenever the control harness is unplugged, you must recalibrate the controls. Follow this procedure to do the calibration:

1. Press the right trigger and start button simultaneously. The numbers after *WHEEL* and *PEDAL* on the screen will change.
2. Turn the steering control to its right limit, and hold it there for 4 seconds. Then turn it to its left limit and hold it there for 4 seconds.

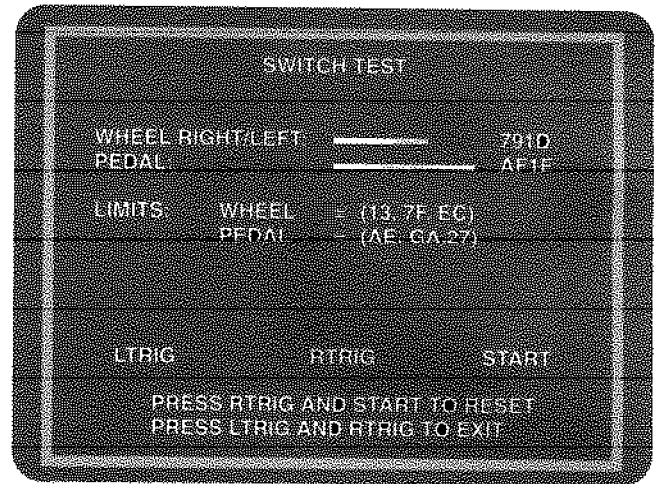


Figure 2-9 Switch Test Screen

3. Press and hold the foot pedal for 4 seconds.
4. Simultaneously press both triggers to save the calibration and exit from the switch test. **Do not simply turn the self-test switch off** to exit from this test; doing so will not save the calibration.

Color Test

This test indicates the dynamic range of the video display color circuit in a series of seven screens. The first color test screen is shown in Figure 2-10. Advance to each screen by pressing the right trigger (the software cycles through all seven screens and then starts over again). The screens are as follows:

1. Red at the top, followed by green, blue, and white
2. Yellow at the top, followed by light blue, purple, and white

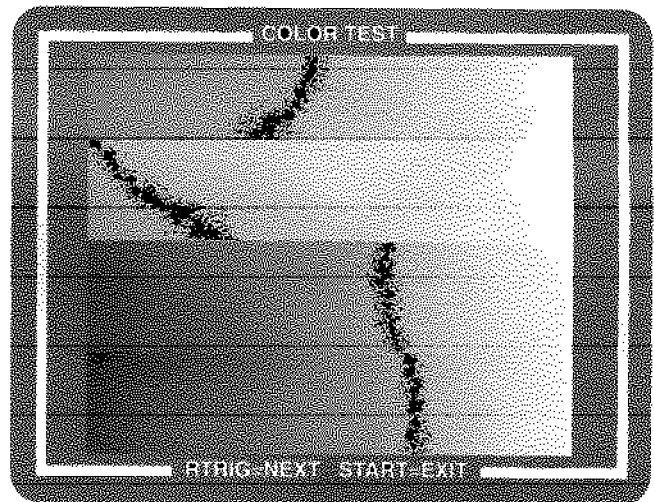


Figure 2-10 Color Test Screen

3. Solid red
4. Solid green
5. Solid blue
6. Solid white
7. Solid gray

If the screens do not match this description, adjust the video display as described in the video display manual. Press the START button to exit.

Convergence Test

The convergence test has three screens: first white, then violet, and finally green. The white screen is shown in Figure 2-11. To see the violet and green screens, press the right trigger. Press the START button to go to the test select screen.

Check the following on the screens:

- The grid lines should be straight within 3 mm, and the lines should not pincushion or barrel.
- The convergence of the lines on the violet and white screens should be within 2 mm.

If the screens do not meet these criteria, adjust the video display as described in the video display manual.

Sound Test

The sound test indicates the condition of the sound effects circuit on the game PCB. The sound test screen appears in Figure 2-12.

Use the steering wheel control to select the sound, and press the right trigger to listen to it. Pressing the left trigger stops the sound from playing. Press the START button to return to the select test menu.

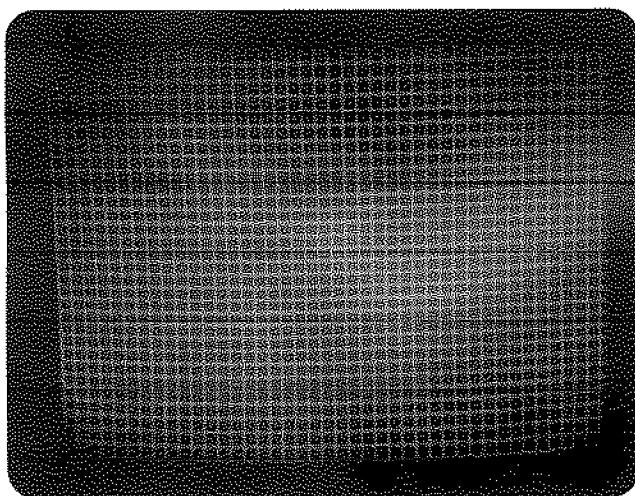


Figure 2-11 Convergence Test Screen

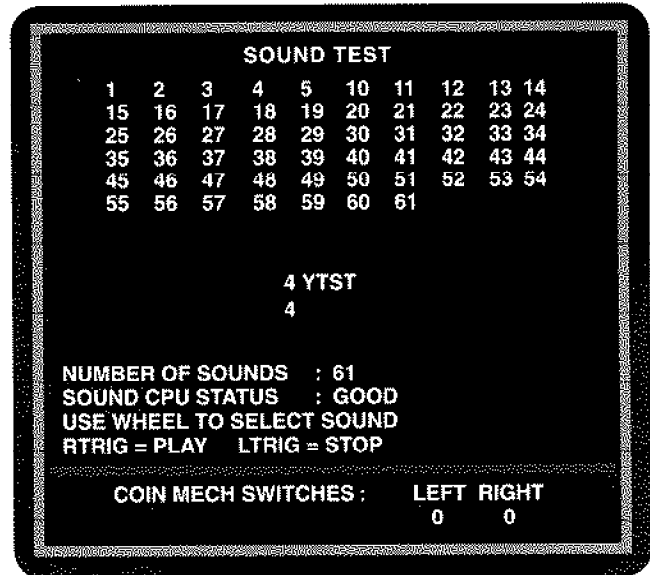


Figure 2-12 Sound Test Screen

ASIC65 Test

Use the ASIC65 test screen to test the comm port, checksum, and internal RAM. The first screen is shown in Figure 2-13. You can select one of the three options shown. Use the left trigger to move to the next option. Use the right trigger to select an option.

If you test the comm port, a message indicates whether or not it's OK. The checksum option displays the checksum. The internal RAM test indicates whether or not the RAM is OK. Press the START button to exit.

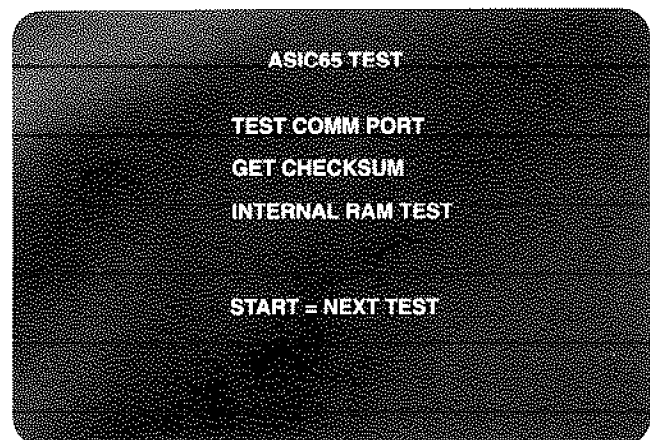


Figure 2-13 ASIC65 Test Screen

DSP Comm Tests and DSP Link Tests

NOTE

These tests only apply if you have installed the optional link kit, to link two upright game cabinets together. The Comm Link board is part of the link kit.

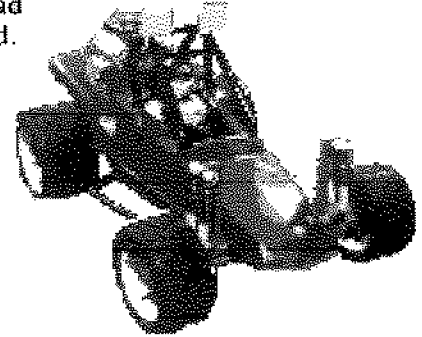
Each of these two main tests has several sub-tests that are selected from menus. These two main tests are described in more detail in the supplement included with the link kit, CO-373-01.

Complete RAM/ROM Test

The RAM/ROM test checks both RAM and ROM. If the test passes, you will see a sequence of color screens, and then the self-test menu screen will reappear. If the screens turn to black and white or gray or if no message appears, the RAM is bad; you will need to replace it. If the ROM is bad, the checksum of the bad ROM is displayed.

You need to replace that ROM.

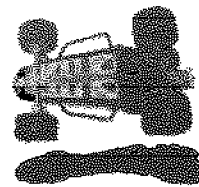
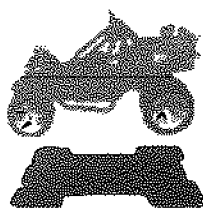
Press the START button to exit.



Troubleshooting and Maintenance

INTRODUCTION

This chapter contains troubleshooting tables and repair procedures for your Road Riot 4WD™ game. The



chapter has two parts. The first part contains three troubleshooting tables. The tables contain general troubleshooting information, the voltage levels and test points on the printed-

circuit boards, and a list of ROM-caused problems, with specific ROMs to check and replace. ♦ The last part of the chapter has information about connecting the video display (if it requires separate positive sync) and repair information for the steering and foot pedal controls.

Problem	Suggested Action
Coin Mechanism Problem	<ol style="list-style-type: none"> 1. Check the wiring to the coin mechanism. 2. Check the voltage to the + side of the mechanism. 3. Test the coin mechanisms with the sound test screen in the self-test.
Game Play Problem	<ol style="list-style-type: none"> 1. Check the harness and connectors. 2. Perform the self-test. 3. Check the voltage levels on the PCB. See Table 3-2, <i>Voltage Inputs and Test Points</i>. 4. Check <i>What ROM Problems Look Like</i>, Table 3-3, for specific ROM problems.
Steering/Foot Pedal Problems	<ol style="list-style-type: none"> 1. Have the controls been lubricated with the correct type of lubricant? If not, lubricate them shown in Figures 4-2 and 4-3. 2. Check the harnesses and connectors. 3. Check the switches on the control. 4. If you took the control apart, have you reassembled it correctly? 5. Make sure all the parts on the control are in good repair. Repair or replace parts. 6. Reset the limits on the steering control and the foot pedal.
Sound Problem	<ol style="list-style-type: none"> 1. Is the speaker volume turned up? (Volume is adjusted digitally in the self-test.) 2. Check the voltage on the JAMMA connector. 3. Check the wiring from the PCB to the speaker. 4. Check the voltage level to the PCB. See Table 3-2, <i>Voltage Inputs and Test Points</i>. 5. Replace the speaker.
Video Display Problem Screen is dark.	<ol style="list-style-type: none"> 1. Is the game plugged in? 2. Is the game turned on? 3. Are the connections good? 4. Is the line fuse good? 5. Is the display brightness turned up? 6. Are the solder connections on the line filter and transformer good? 7. Is the JAMMA connector on the PCB tightly connected? 8. Check all of the items below. If you answer <i>no</i> to any question, you have a problem with the video display, not with the game circuitry. See your video display service manual. <ol style="list-style-type: none"> a. Do you have power to the video display? b. Are the video display's filaments lit? c. Do you have high voltage to the video display? 9. Are the voltage levels to the video display PCB correct? (Power voltage is 100 VAC or 110 VAC, depending on the type of video display. Video signal voltage is 0.5 to 3.5 Volts.) 10. If the level is not correct, check the connectors and the harness.
Only a colored screen appears.	You probably have a serious RAM problem.
Display area wavers or is too small.	<ol style="list-style-type: none"> 1. Do you have correct power voltage to the video display PCB? 2. Do you have correct high voltage to the video display?
Picture is wavy.	<ol style="list-style-type: none"> 1. Is the monitor ground connected to the monitor? 2. Are the sync inputs connected properly?
Picture is upside down.	When you serviced the display, you connected the wires incorrectly. Switch the horizontal or vertical yoke wires on the display.
Convergence, purity or color problems.	Use the screens in the self-test to adjust the video display. Use the adjustment procedures in your video display manual.
Picture is not centered.	Use the centering procedures in your video display manual.

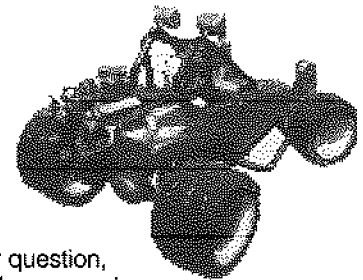


Table 3-1 Troubleshooting Table

Voltage	Test Point or LED	Source and Purpose
+5 ± 0.25 VDC	+5V1	Logic power from the switching power supply.
	CR3 LED (Game PCB)	Lights when 5 V is applied to the PCB and the reset (RST) jumper is open.
	CR9 LED (JSA Audio III PCB)	Lights when the +12 V supply is good.
	CR3 LED (JSA Audio III PCB)	Lights when the -5 V supply is good.
+12 V	+V0P (pin 4 of LM324)	+12 V from the switching power supply. Positive supply for the analog circuitry.
-5 V	-V0P (pin 11 of LM324)	-5 V from the switching power supply (if connected). Negative supply for the analog circuitry.

Table 3-2 Voltage Inputs and Test Points on the PCBs

Problem	ROM Causing the Problem	Check the ROM at:
Program works, but motion objects or playfield is wrong.	Graphics ROMs	Playfield: 20C–22C, 20D–22D. Motion Object High: 2S–9S. Motion Object Low: 2P–9P. Alphanumerics: 22J
Garbage on screen; program doesn't work.	Processor Program ROM 0	14B/C 8C, 8D
Game program is erratic.	Program ROM 1	9C, 9D
No sound or erratic sound.	Audio Program Audio ADPCM	12C 12E, 15E, 17E, 19E

Table 3-3 What ROM Problems Look Like

Video Display Sync Problems

This game board provides separate positive horizontal and vertical sync on a separate connector, for monitors that will not work with the composite negative sync signal provided at the JAMMA edge connector.

This connector (labeled "Sync") is located near the edge connector. Pin 1 is horizontal sync, Pin 2 is vertical sync, and Pin 3 is ground.

Troubleshooting

The tables in this chapter (3-1, 3-2, and 3-3) can help you troubleshoot problems in your game. The troubleshooting table lists possible sources of problems in various parts of the game. The voltage inputs and test points can help you troubleshoot PCB problems. The ROM problems table can help determine exactly which ROM might be causing game play problems.

Removing and Replacing the Steering Control

The steering control is shown in Figure 4-2. If you want to repair the X-Y steering control, disassemble it by removing it from the control mounting bracket (pod) on the control panel. The hardware that secures the pod and steering control is shown in Figure 1-1.

Pin	Signal	Pin	Signal
1	Red	7	GND
2	GND	8	GND
3	Key	9	Neg. composite sync
4	Green	10	Positive V sync
5	GND	11	Positive H sync
6	Blue		

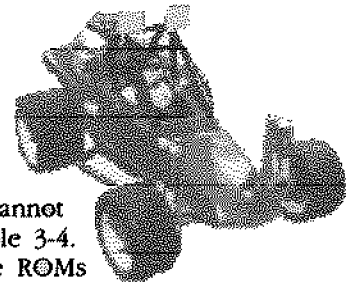
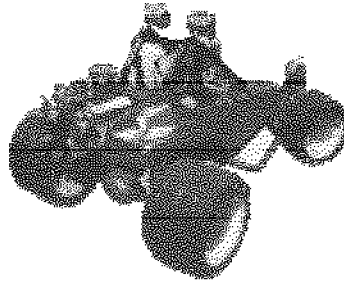
Table 3-4 Atari Games Video Connector Pin Assignments

Removing and Replacing the Foot Pedal Assembly

The foot pedal assembly is shown in Figure 4-3. If you want to repair the foot pedal, disassemble it by removing it from the front of the game cabinet. The hardware that secures the foot pedal is shown in Figure 1-1.

ROMs and RAMs

If you think you have bad ROMs or RAMs, perform the ROM or RAM test in the self-test procedure. If you have a ROM problem, see Table 3-3. If you see



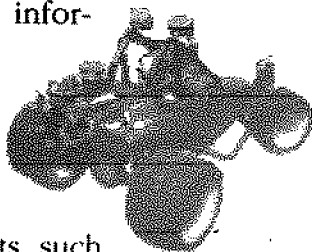
only a colored screen and cannot enter the self-test, see Table 3-4. For the location of all the ROMs and RAMs on the game PCB, see Figure 4-5.

Parts Illustrations

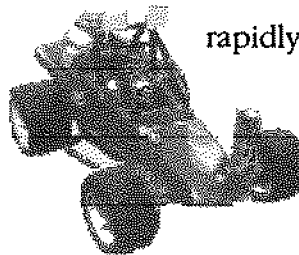
INTRODUCTION

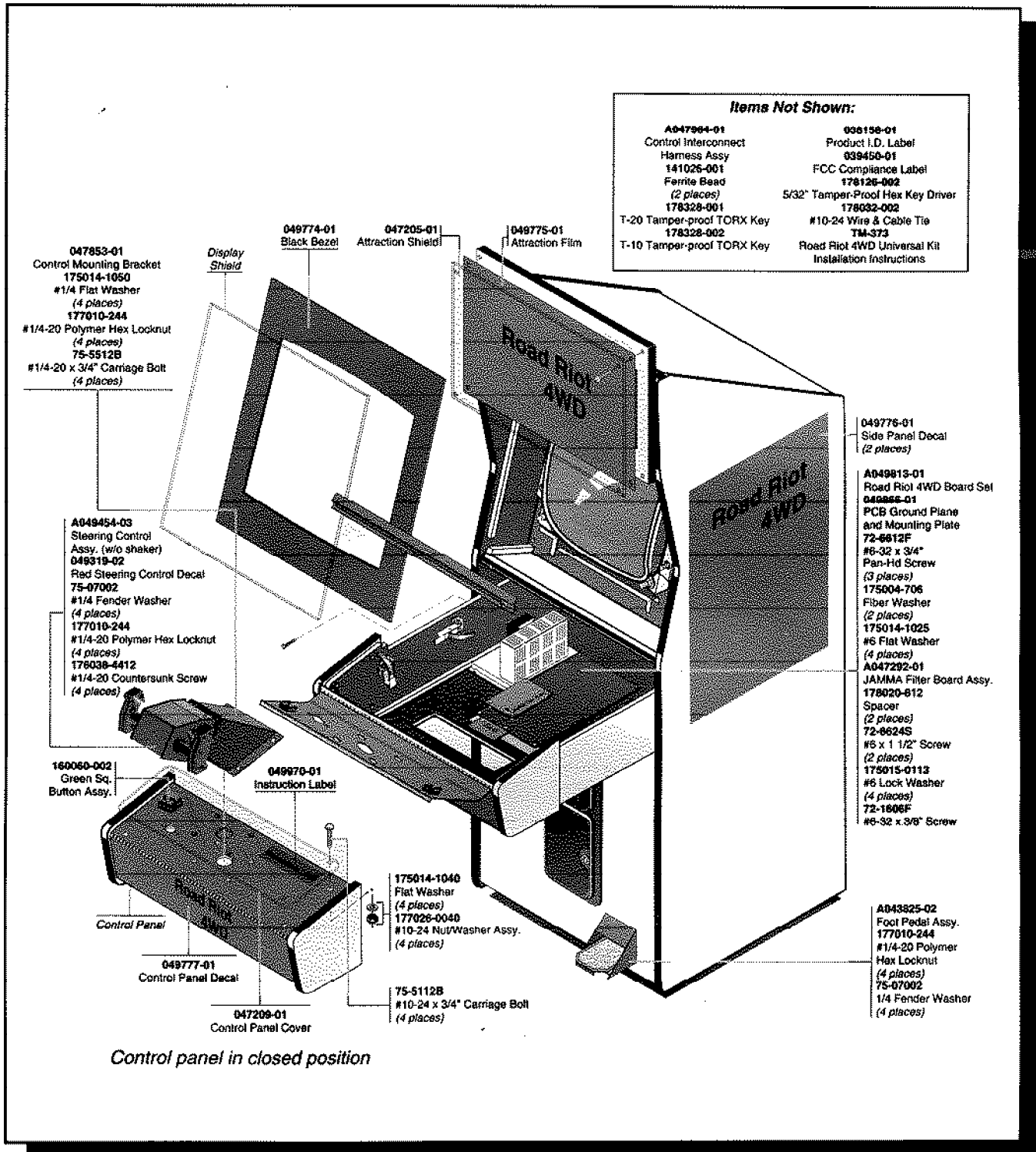
This chapter provides information you need to order replacement parts for your kit.

Common hardware parts, such as screws, nuts, washers, and so on, are included in these parts illustrations. ♦ When you order parts, give the part number, part name, the number of this manual, and the

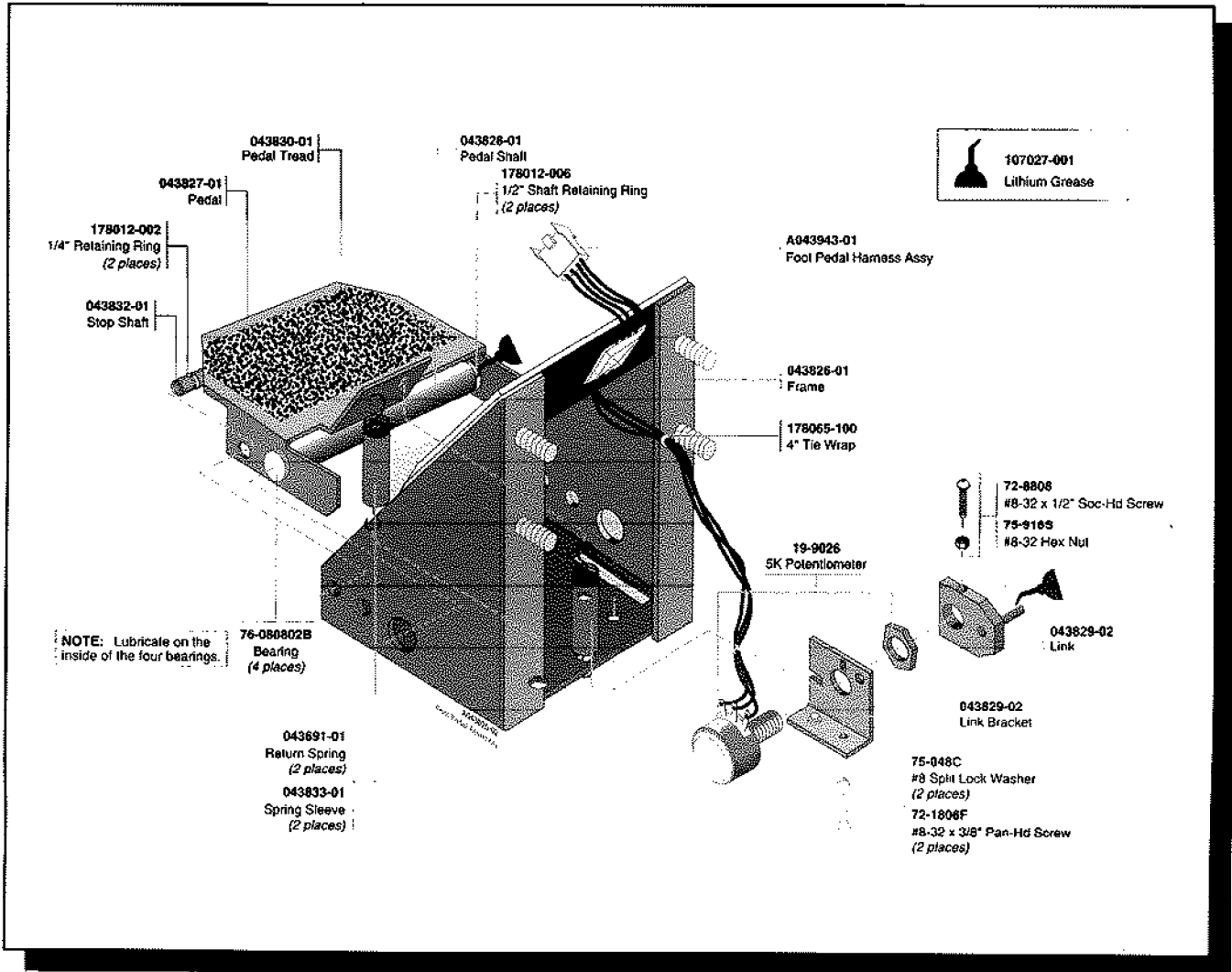


serial number of your game. With this information, we can fill your order rapidly and correctly. We hope this will create less downtime and more profit from your games. Atari Games Customer Service phone numbers are listed on the inside front cover of this manual.

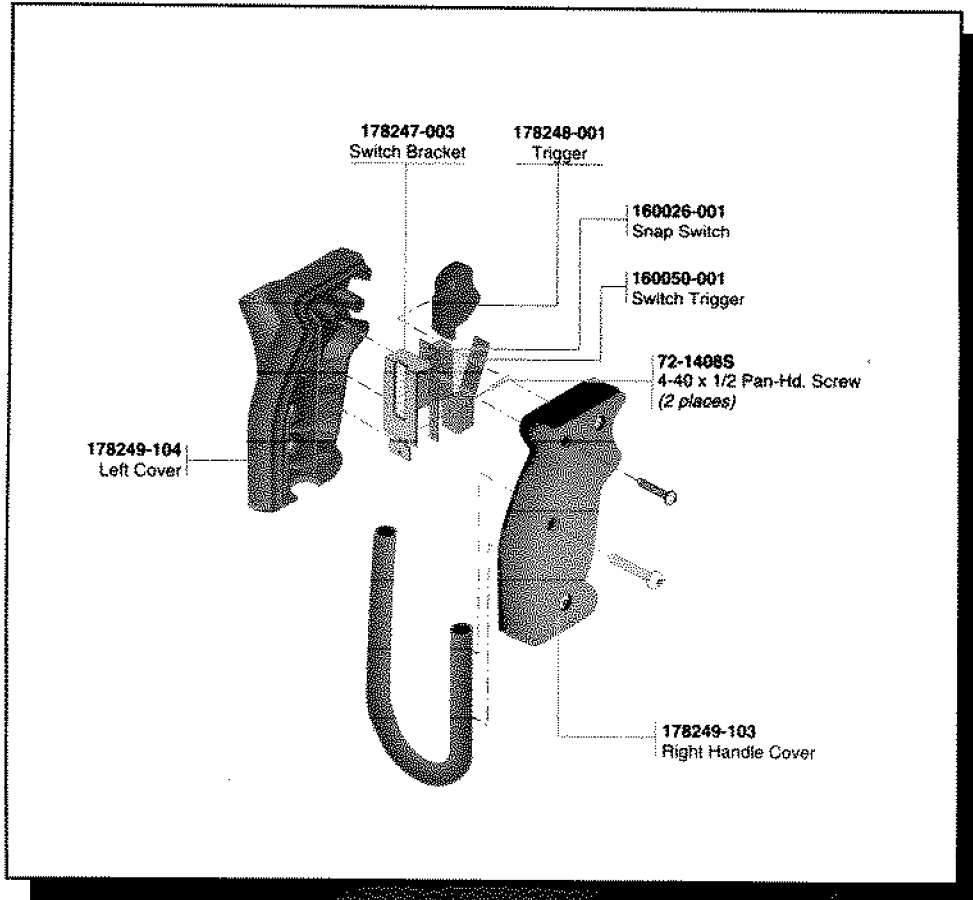




**Figure 4-1 Parts of Road Riot 4WD Universal Kit
A049868-01 C**



**Figure 4-2 Foot Pedal Assembly
A043825-02 D**



**Figure 4-3 X-Y Steering Control Assembly
A049454-03 B**

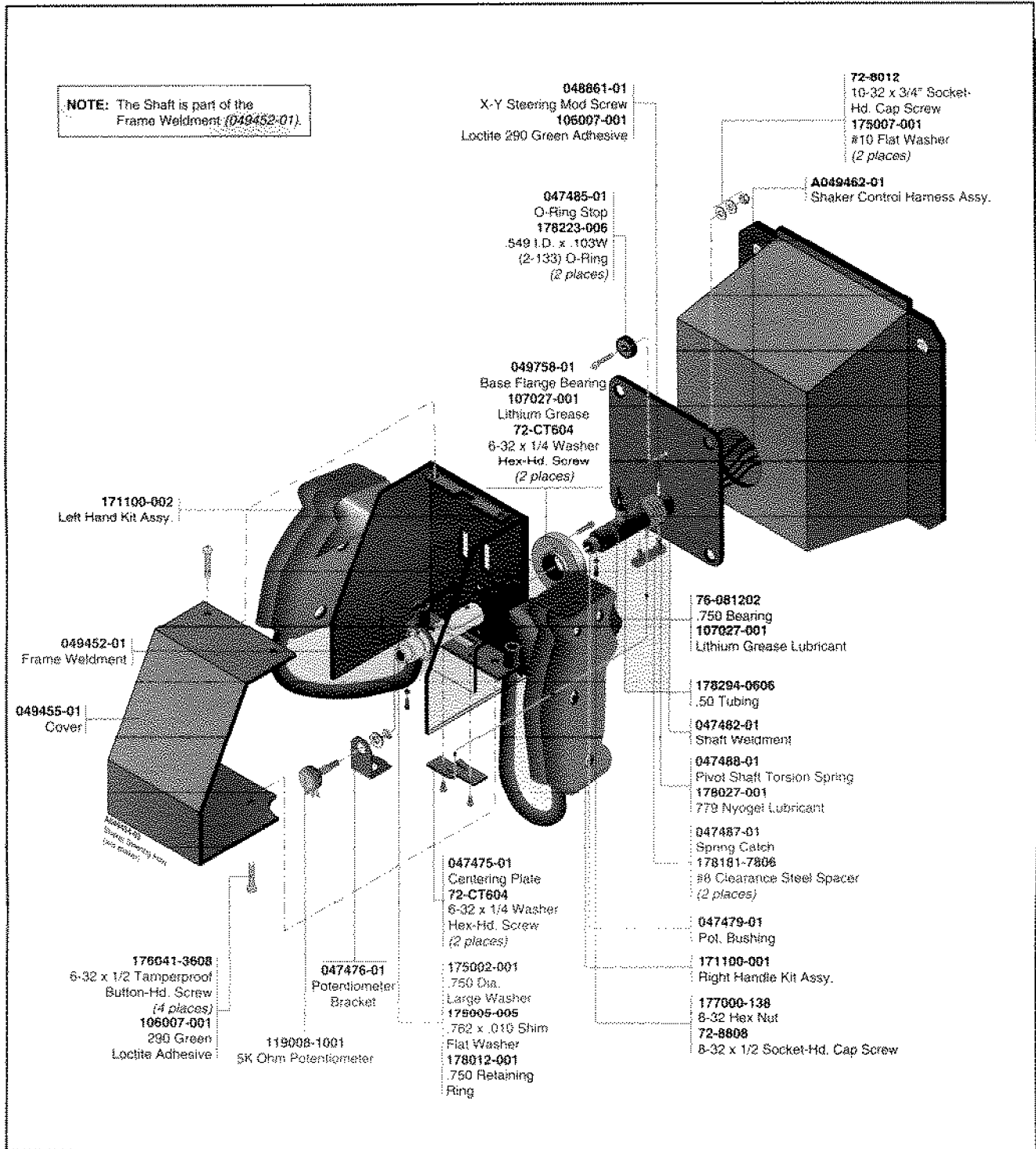
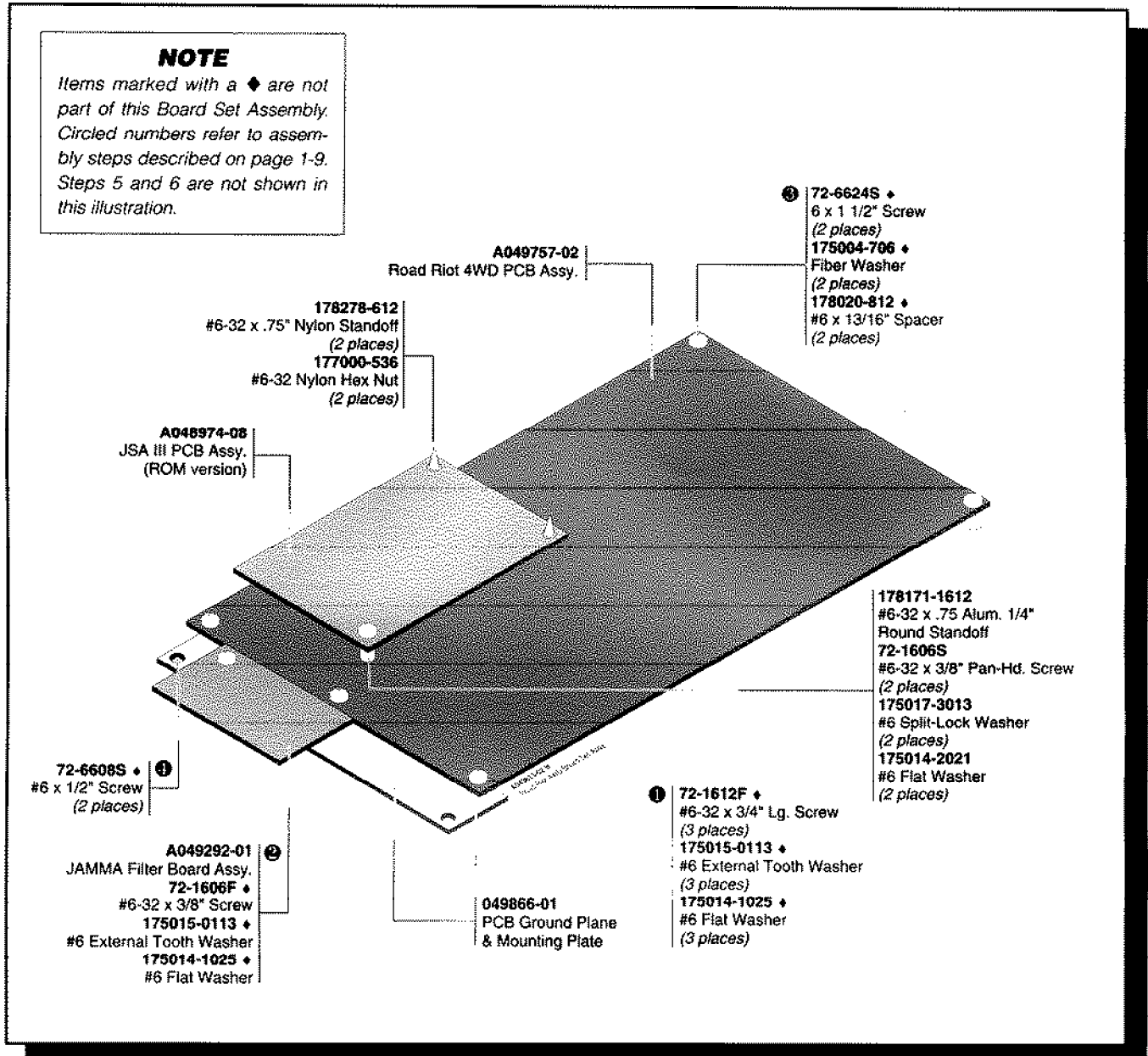
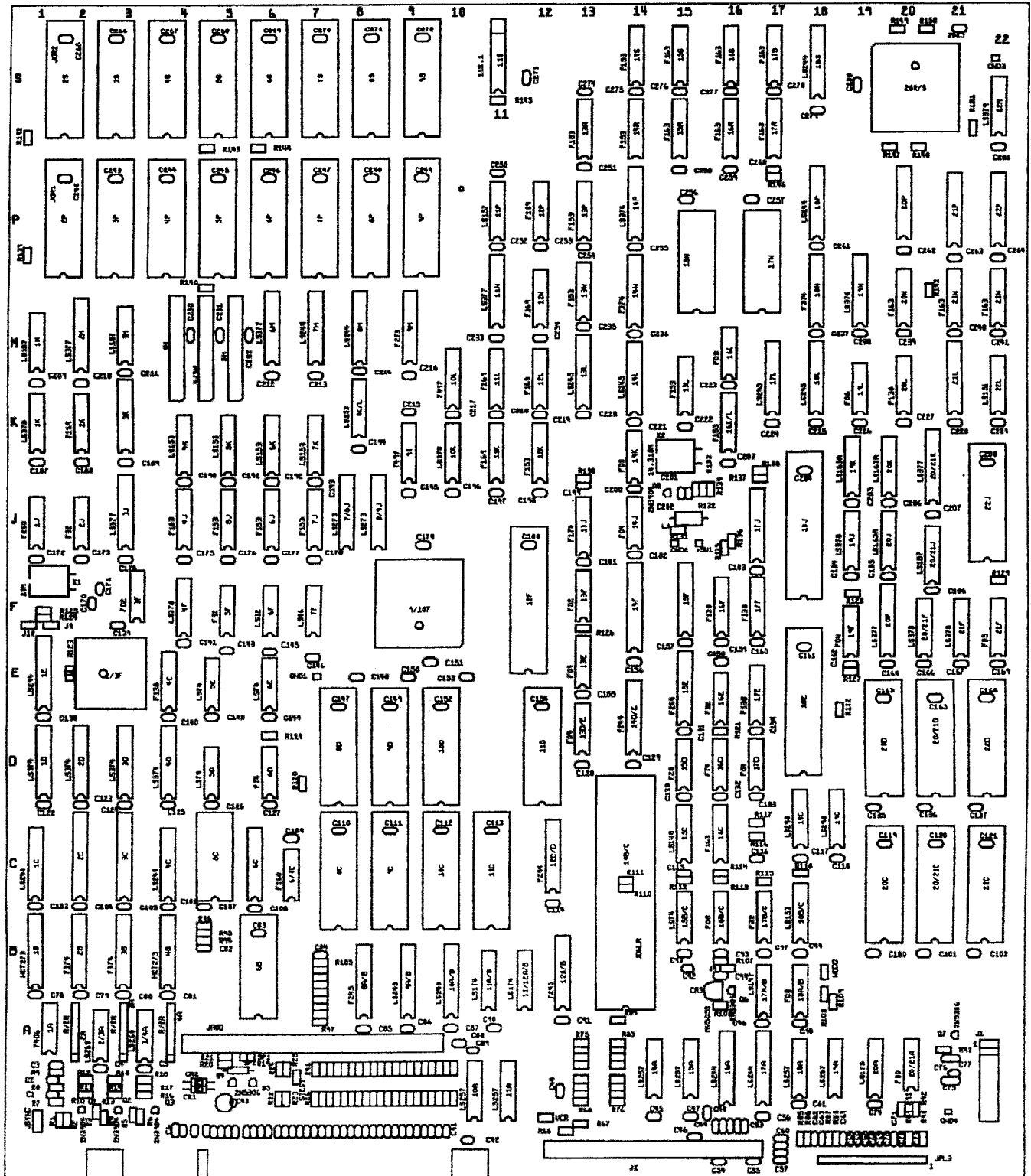


Figure 4-3 X-Y Steering Control Assembly, Continued
A049454-03 B



**Figure 4-4 Road Riot 4WD Board Set Assembly
A049813-02 B**



NOTE: Your Road Riot 4WD Game PCB probably has one 4-meg. ROM at location 2S. If so, it should have a modification wire that connects 2P, pin 22 to 11S, pin 3. However, your Game PCB may instead have four 1-meg. EPROMs at locations 2S through 5S. In that case, you should have **no** modification wire on the game PCB.

Figure 4-5 Road Riot 4WD Game PCB Assembly
A049757-01 A

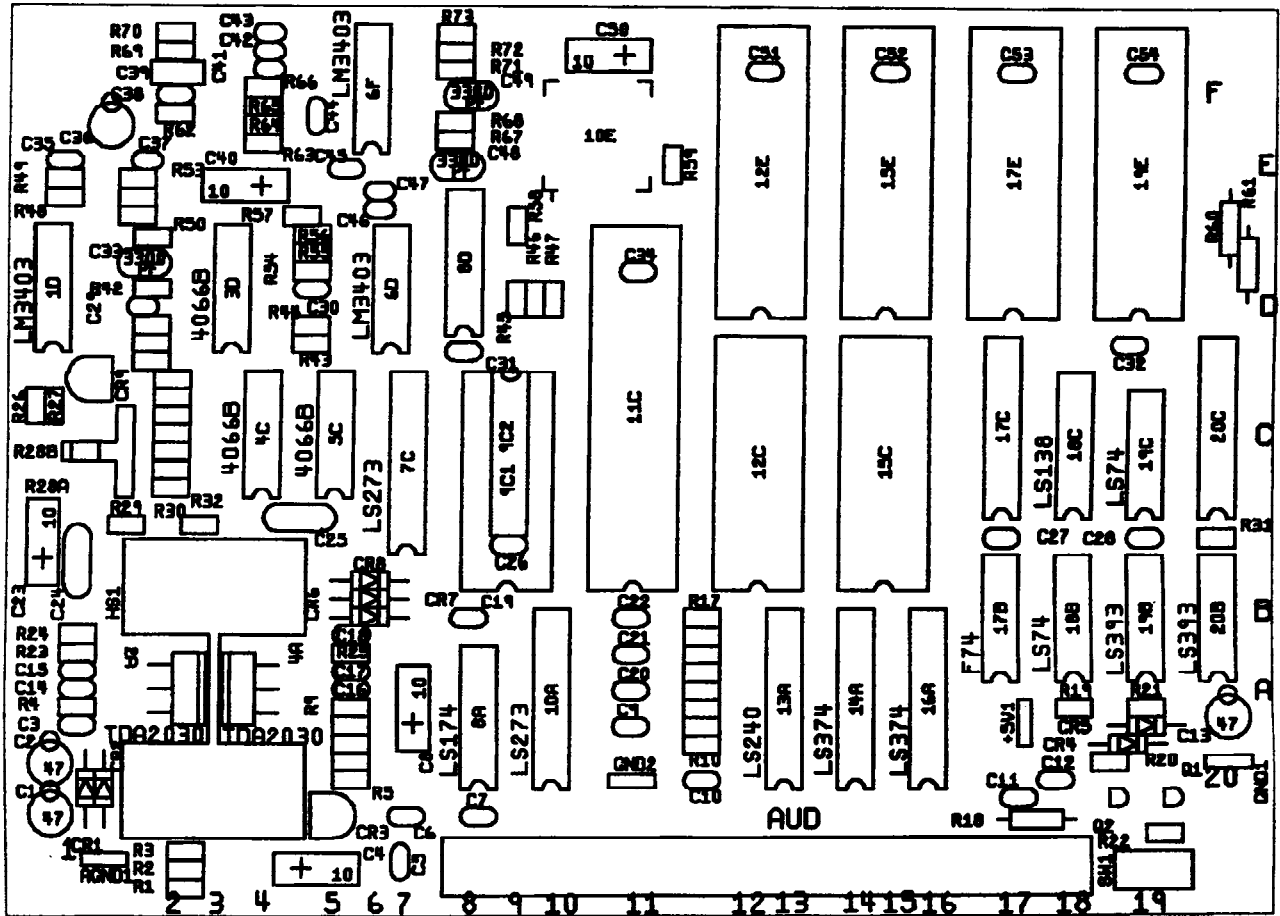


Figure 4-6 JSA (JAMMA Stand-Alone Audio) III PCB Assembly
A048974-08 A

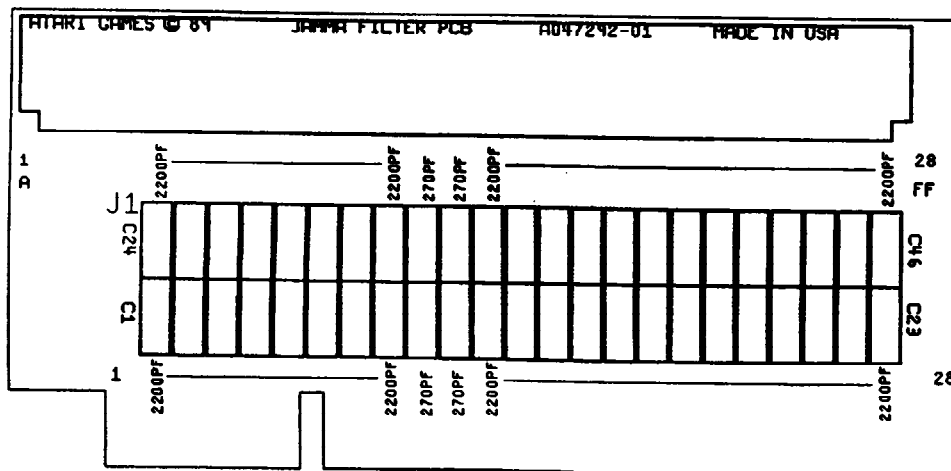


Figure 4-7 JAMMA Filter PCB Assembly
A047292-01 A

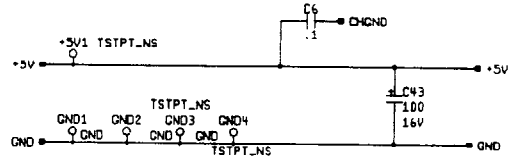
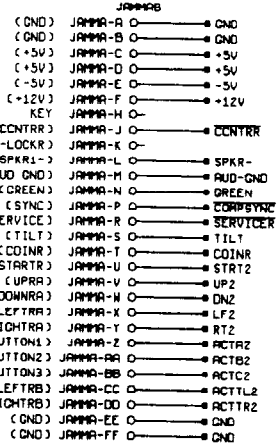
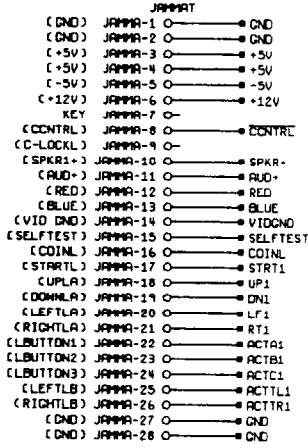
Schematic Diagrams

INTRODUCTION

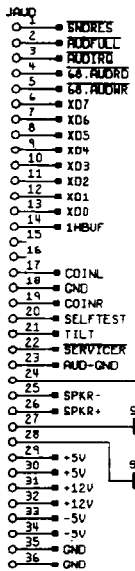
This chapter contains the schematic diagrams for the Road Riot 4WD™ game PCB and the JSA II (audio) PCB.



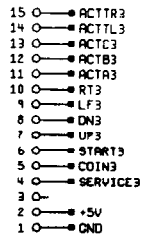
The game PCB and JSA III PCB *assembly drawings* are illustrated in Chapter 4, Parts Illustrations.



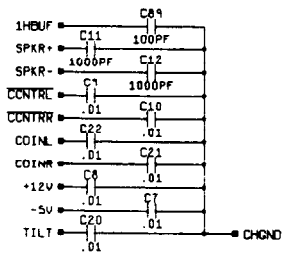
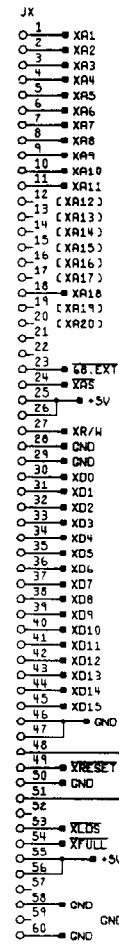
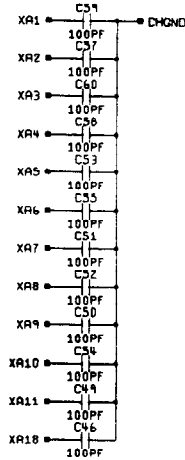
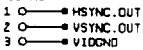
GND — CHGND
CONNECTED AT FINGERS ONLY.



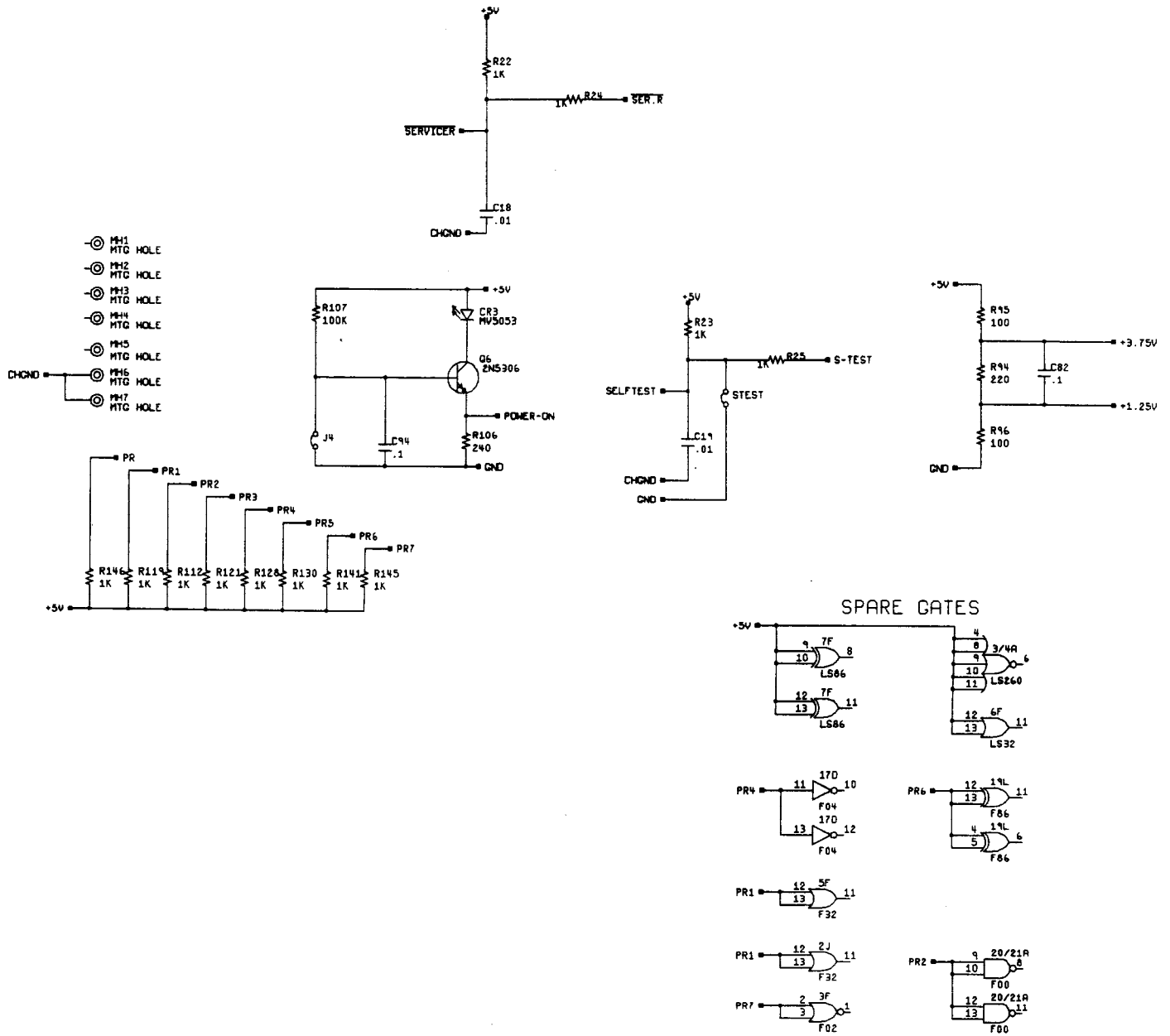
PL3/DIAG
JPL3



JSYNC



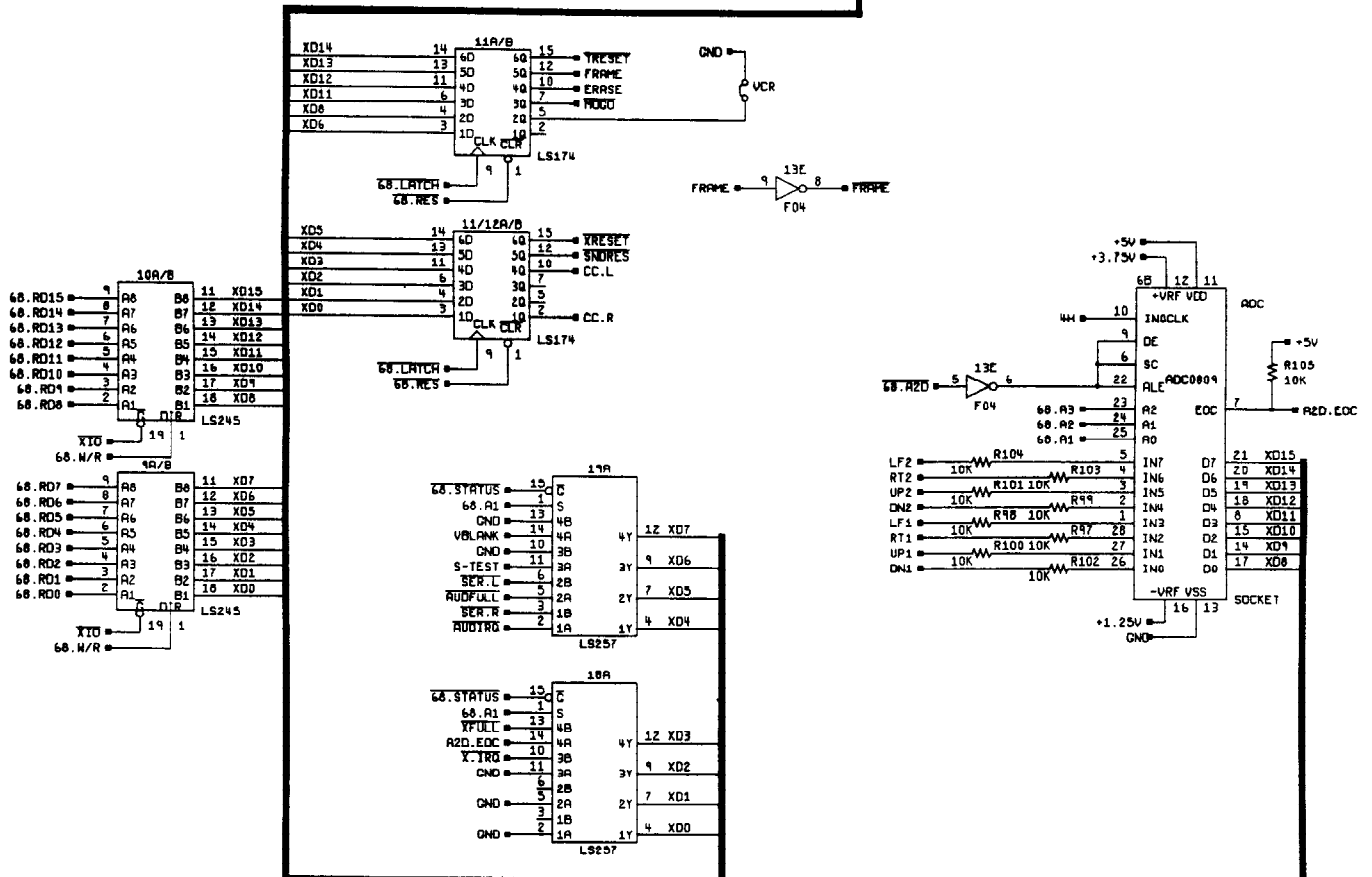
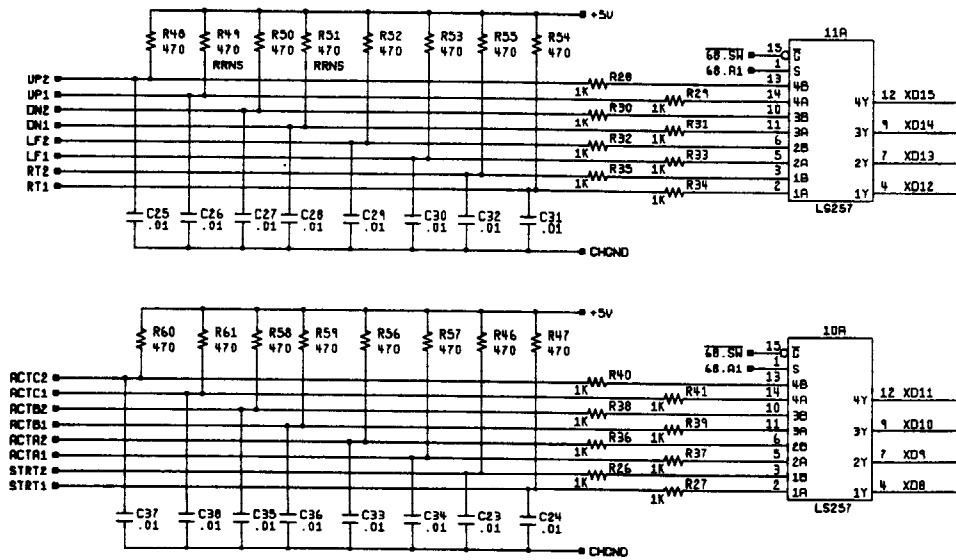
GND — CHGND
CONNECTED AT PINS 58 AND 60 ONLY.

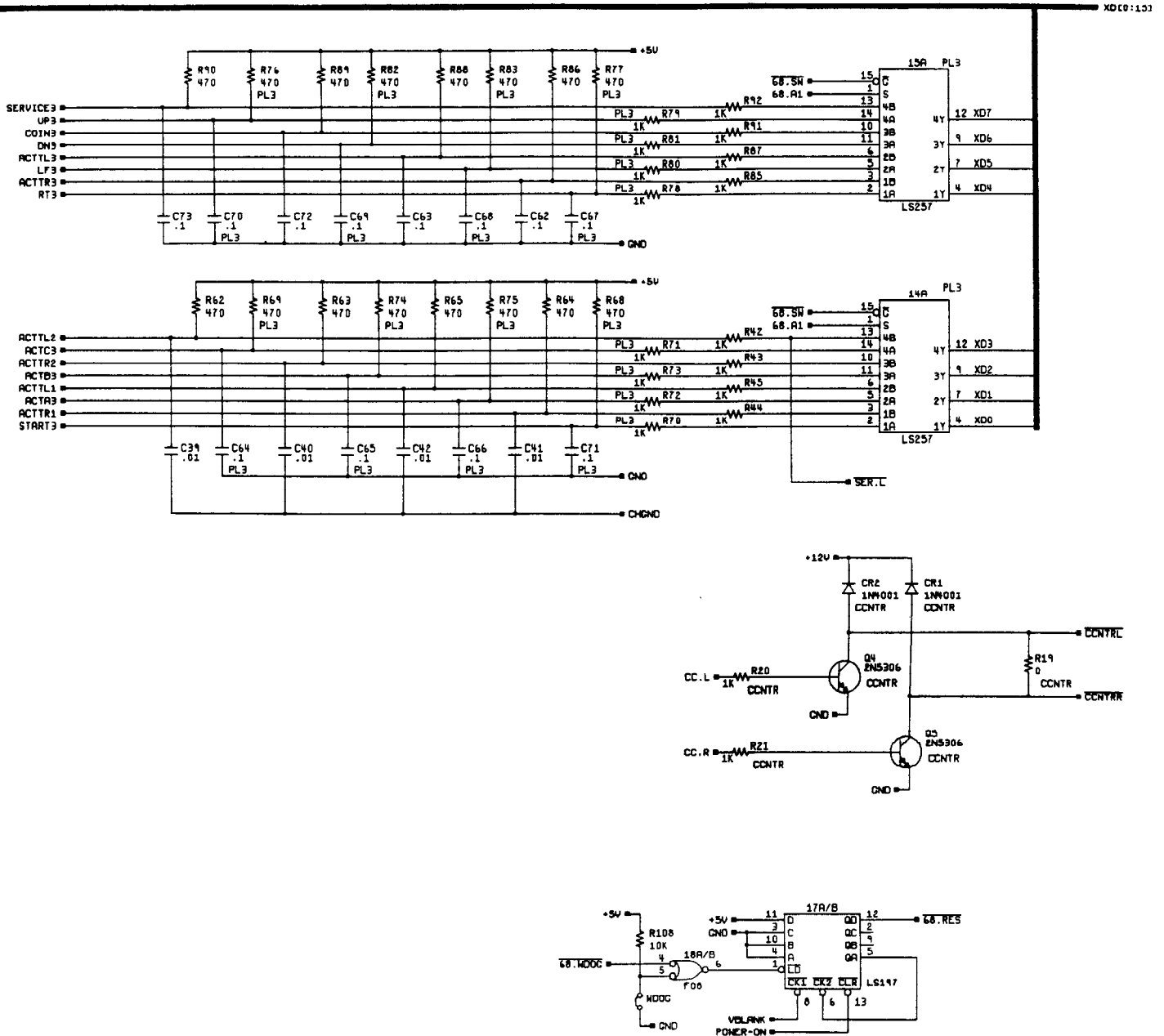


8-19-1991_10:12

Figure 5-1 Road Riot 4WD Game PCB Assembly Schematic Diagram

049756-01 B



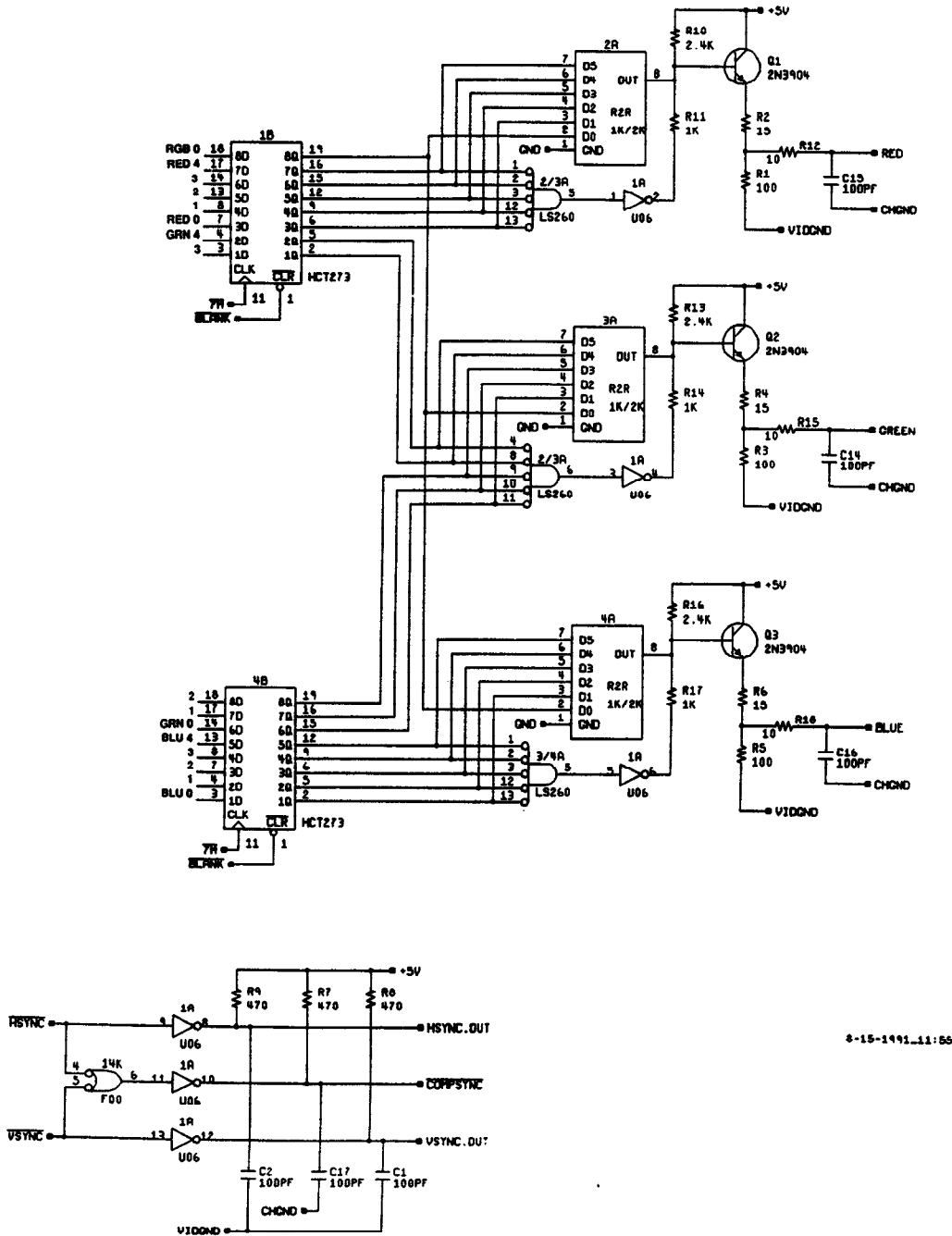


0-15-1991.11:51

Figure 5-1 Road Riot 4WD Game PCB Assembly Schematic Diagram

049756-01 B



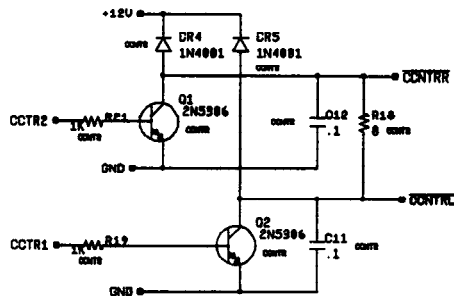
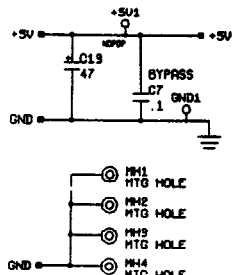
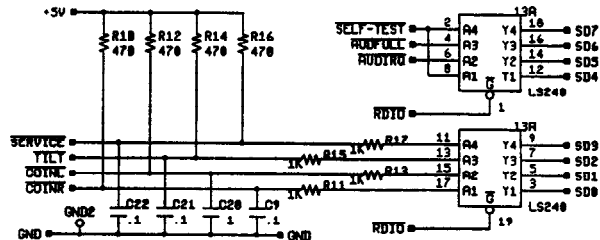
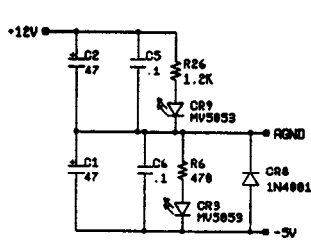
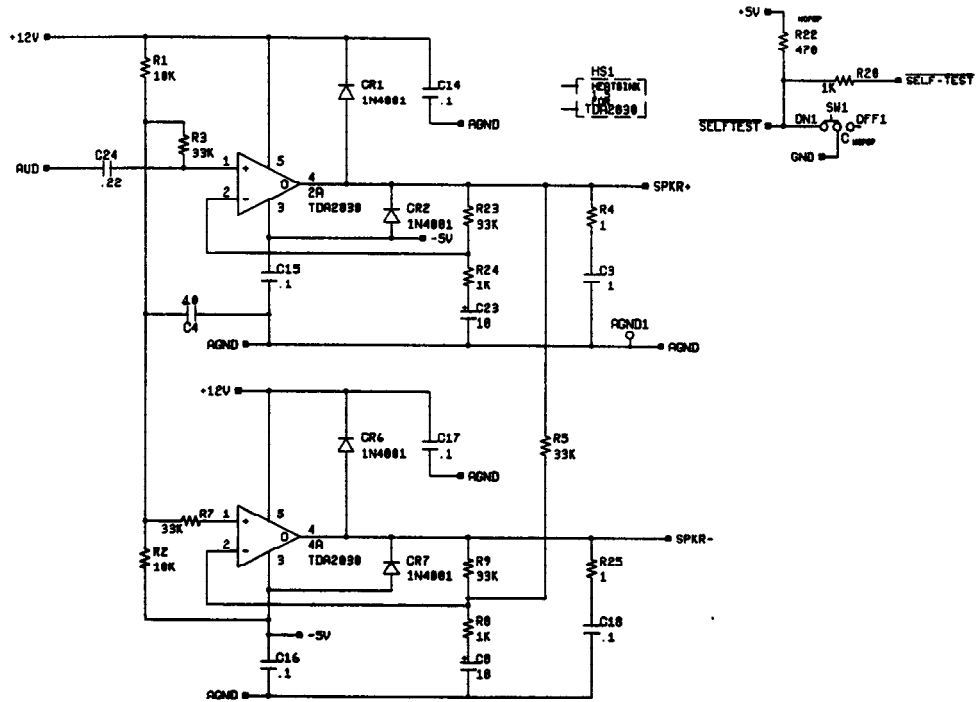


8-15-1991.11:55

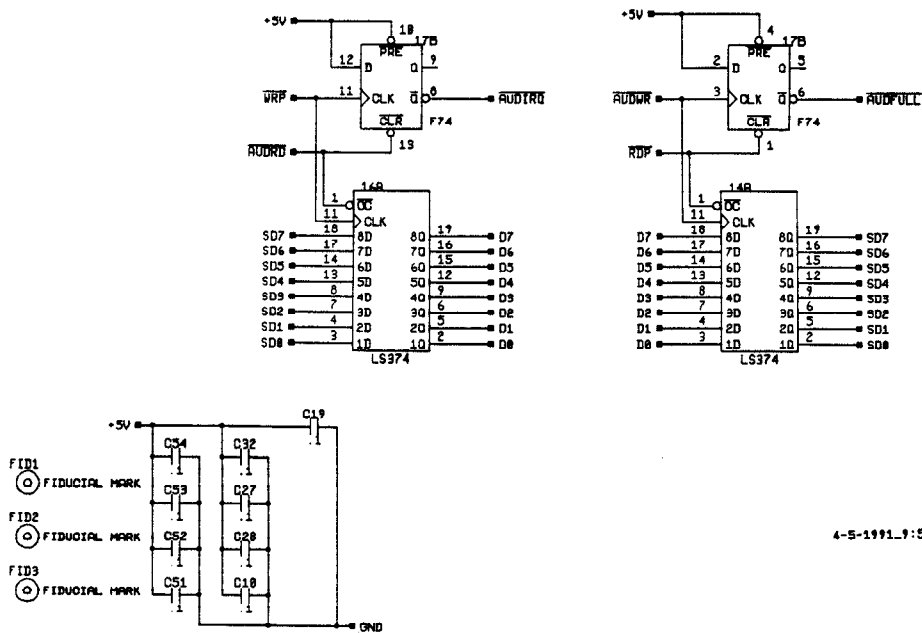
Figure 5-1 Road Riot 4WD Game PCB Assembly Schematic Diagram

049756-01 B

- 1 JAVB
- 2 RESET
- 3 AUDFULL
- 4 AUDTRG
- 5 AUDRD
- 6 AUDNR
- 7 D7
- 8 D6
- 9 D5
- 10 D4
- 11 D3
- 12 D2
- 13 D1
- 14 D0
- 15 3S79K
- 16
- 17 COTRC
- 18 GND
- 19 COTNR
- 20 SELFTEST
- 21 YILY
- 22 SERVICE
- 23 AGND
- 24 AUDOUT
- 25 SPKR-
- 26 SPKR+
- 27 CENTRR
- 28 CENTRL
- 29
- 30 +5V
- 31 -5V
- 32 +12V
- 33 -12V
- 34 -5V
- 35 -5V
- 36 GND

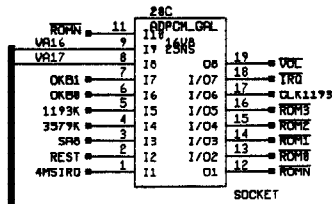
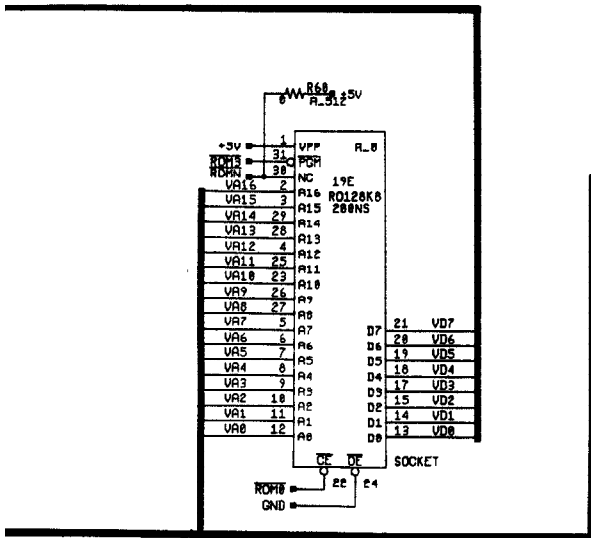
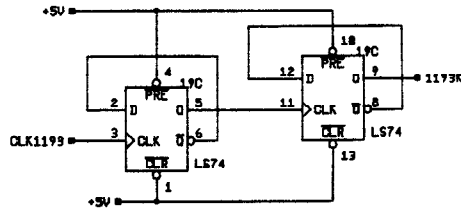
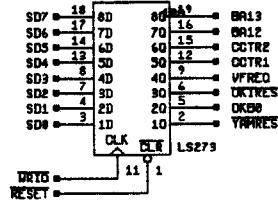
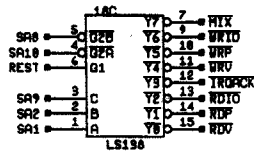
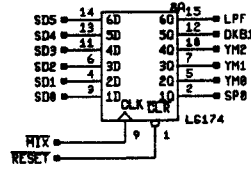
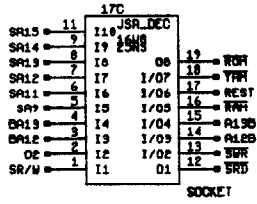


GND AND AGND TIED INTERNALLY NEAR MSM6295



4-5-1991_9:51

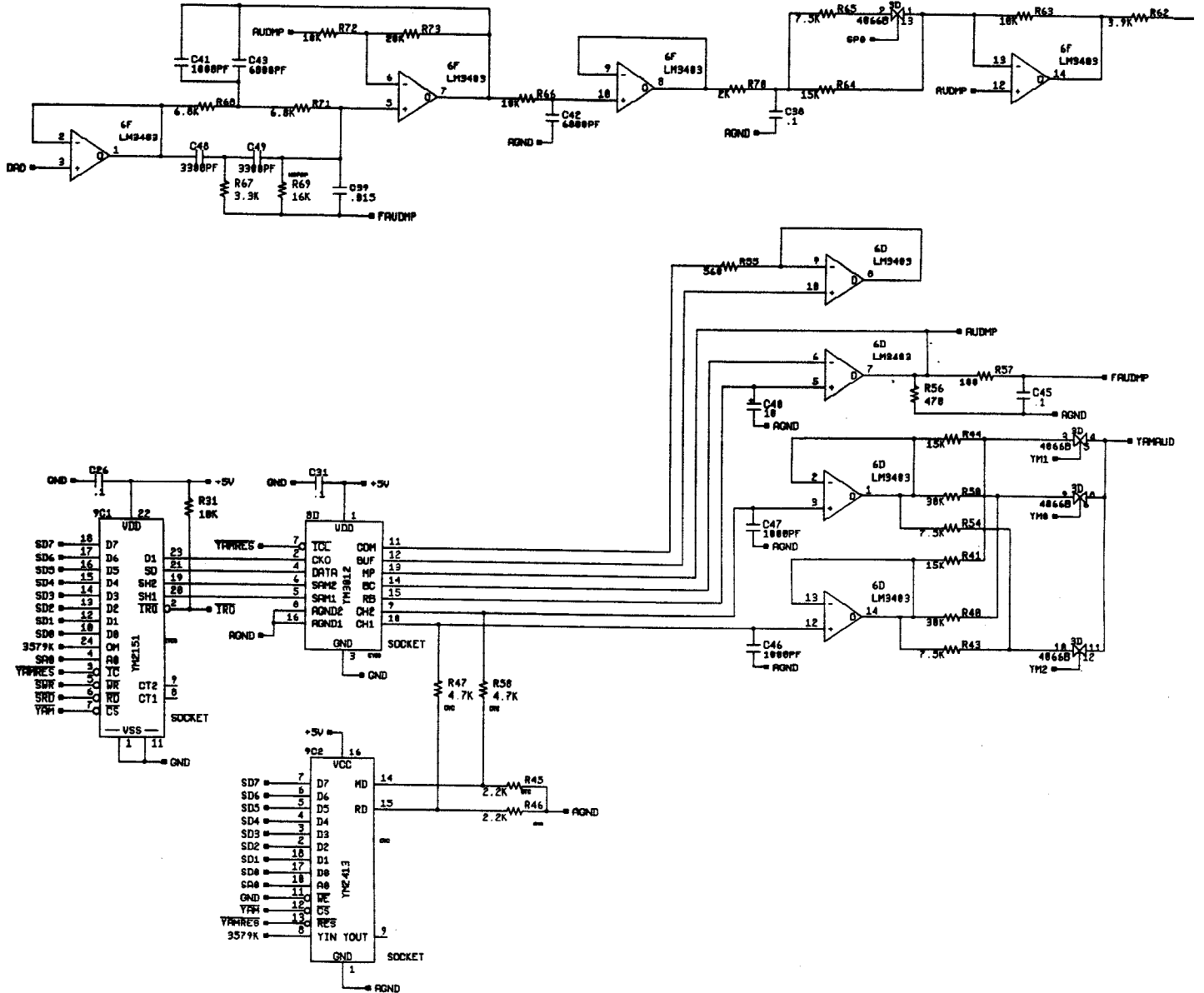
Figure 5-2 JSA Audio III Assembly Schematic Diagram
048973-01 C

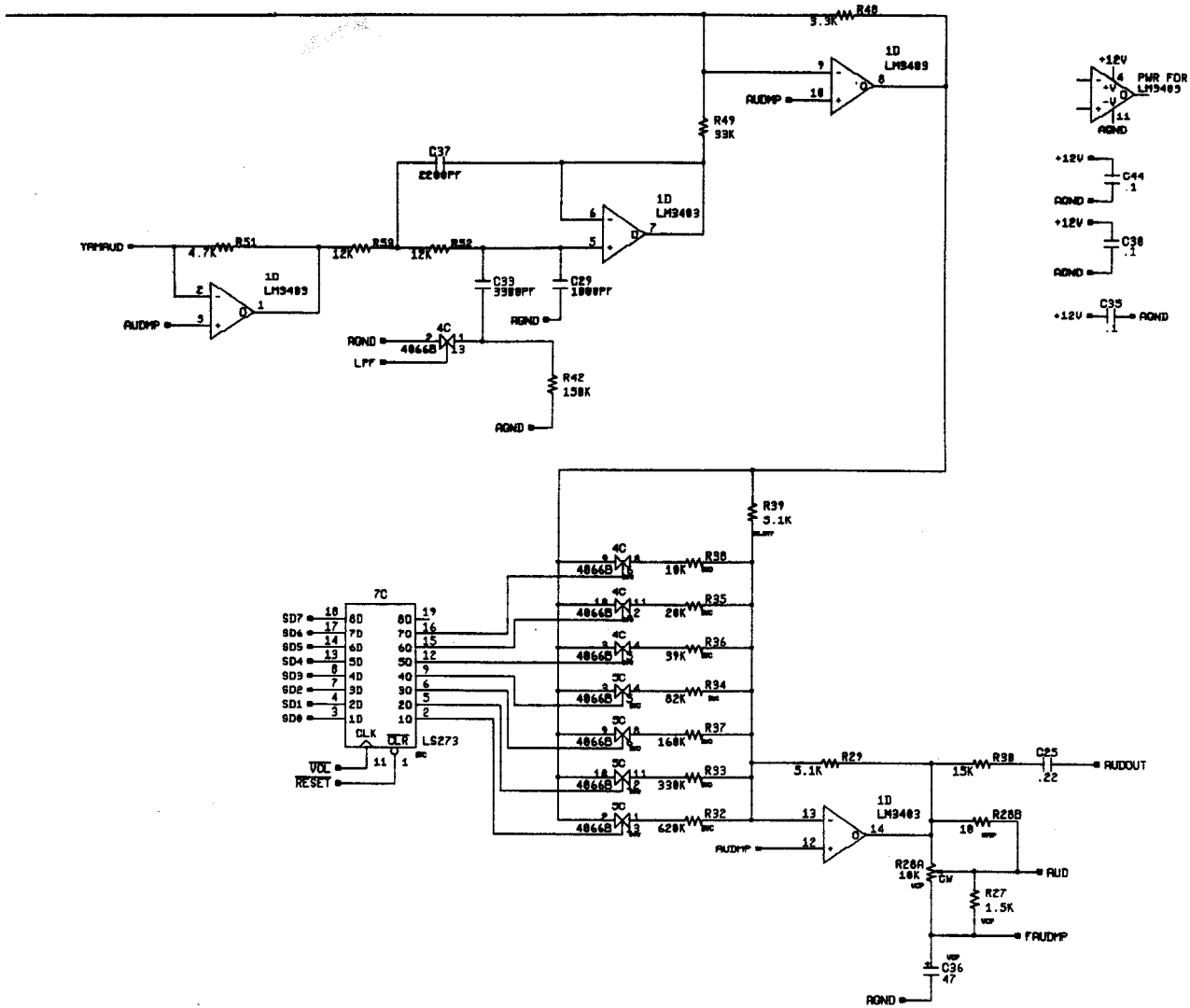


4-9-1991-7:52

Figure 5-2 JSA Audio III Assembly Schematic Diagram

048973-01 C

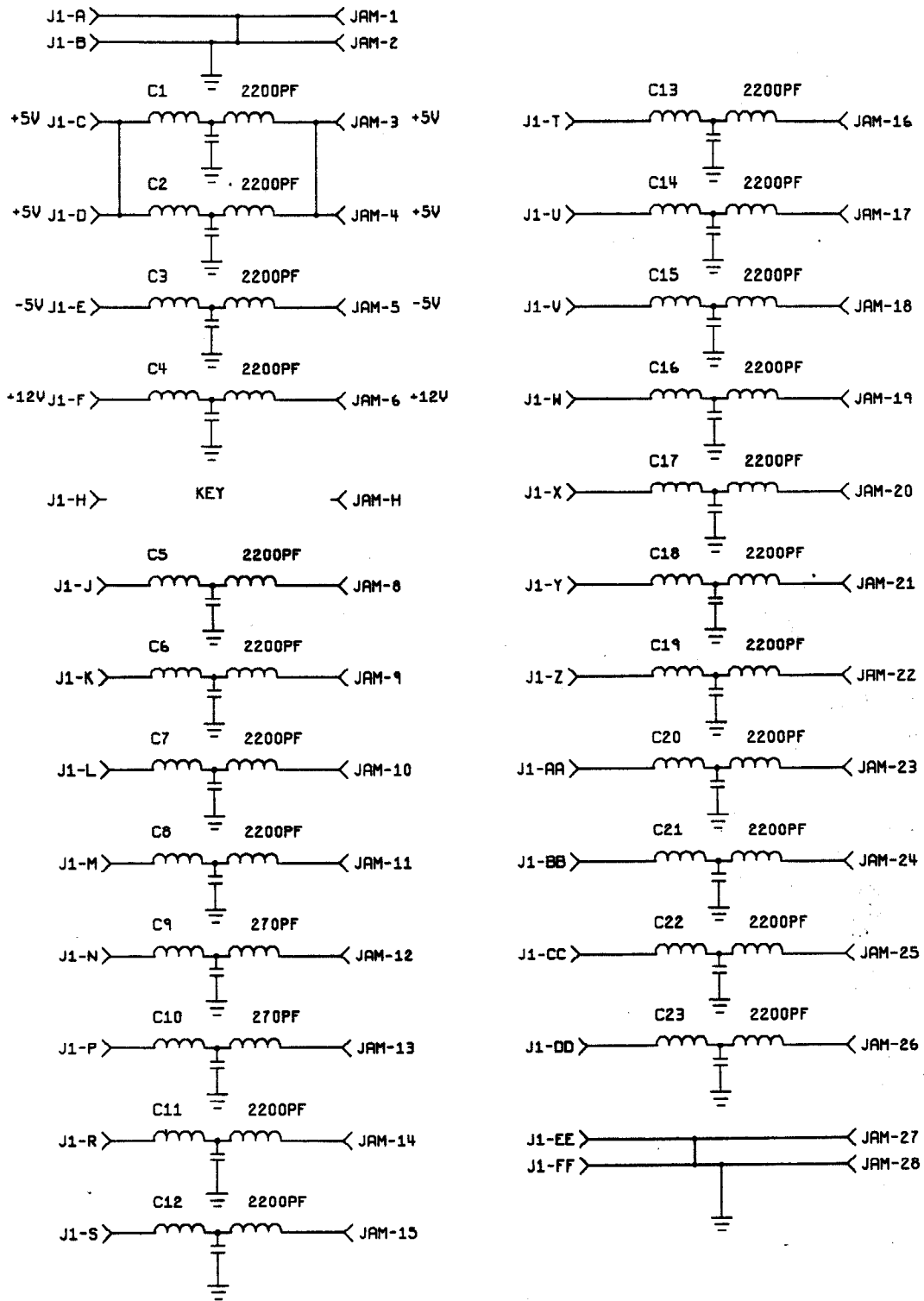




4-5-1991_9:55

Figure 5-2 JSA Audio III Assembly Schematic Diagram

048973-01 C



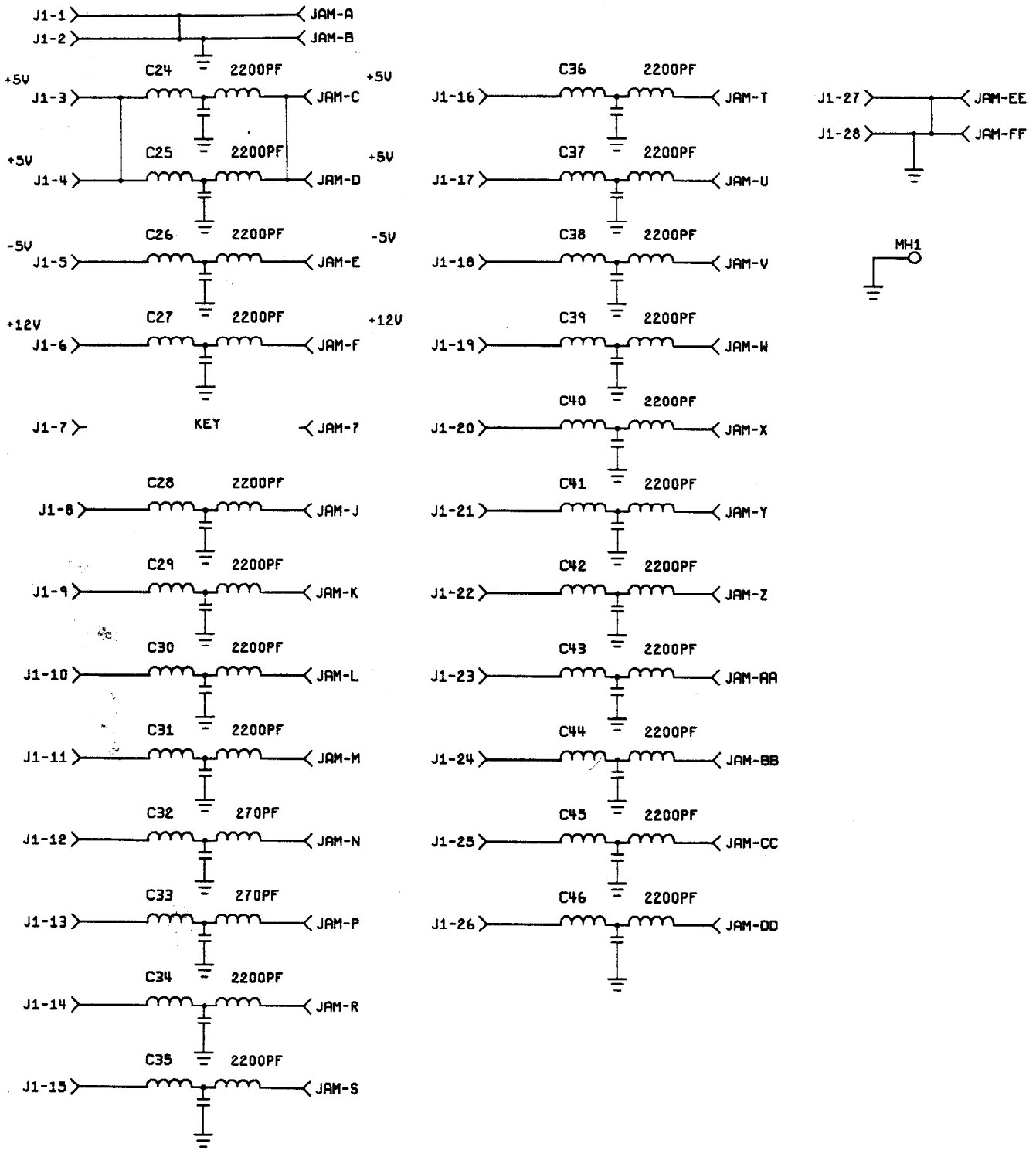


Figure 5-3 JAMMA Filter PCB Assembly Schematic Diagram

047292-01 A

Glossary

AC

Alternating current; from zero it rises to a maximum positive level, then passes through zero again to a maximum negative level.

ACTIVE STATE

The true state of a signal. For example: The active state for is low.

ADDRESS

A value that identifies a specific location of data in memory; normally expressed in hexadecimal notation.

ANALOG

Measurable in an absolute quantity (as opposed to on or off). Analog devices are volume controls, light dimmers, stereo amplifiers, etc.

ANODE

The positive (arrow) end of a diode.

AMPLIFIER

A device used to increase the strength of an applied signal.

AMPLITUDE

The maximum instantaneous value of a waveform pulse from zero.

ASTABLE

Having no normal state; An astable device will free-run or oscillate as long as operating voltage is applied. The oscillation frequency is usually controlled by external circuitry.

AUXILIARY COIN SWITCH

A momentary-contact pushbutton switch with a black cap located on the utility panel. The auxiliary coin switch adds credits to the game without activating a coin counter.

BEZEL

A cut, formed, or machined retention device, such as the conical device used to mount a pushbutton switch to a control panel, or the formed device used to frame the video display screen.

BIDIRECTIONAL

Able to send or receive data on the same line (e.g., the data bus of a microprocessor).

BINARY

A number system that expresses all values by using two digits (0 and 1).

BIT

A binary digit; expressed as 1 or 0.

BLANKING

Turning off the beam on a cathode-ray tube during retrace.

BLOCK DIAGRAM

A drawing in which functional circuitry units are represented by blocks. Very useful during initial troubleshooting.

BUFFER

1. An isolating circuit designed to eliminate the reaction of a driven circuit on the circuits driving it (e.g., a buffer amplifier).

2. A device used to supply additional drive capability.

BUS

An electrical path over which information is transferred from any of several sources to any of several destinations.

CAPACITOR

A device capable of storing electrical energy. A capacitor blocks the flow of DC current while allowing AC current to pass.

CATHODE

The negative end of a diode.

CHIP

An integrated circuit comprising many circuits on a single wafer slice.

CLOCK

A repetitive timing signal for synchronizing system functions.

COINCIDENCE

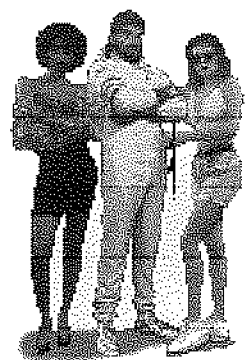
Occurring at the same time.

COIN COUNTER

A 6-digit electromechanical device that counts the coins inserted in the coin mechanism(s).

COIN MECHANISM

A device on the inside of the coin door that inspects the coin to determine if the correct coin has been inserted.



COMPLEMENTARY

Having opposite states, such as the outputs of a flip-flop.

COMPOSITE SYNC

Horizontal and vertical synchronization pulses that are bused together into a single signal. This signal provides the timing necessary to keep the display in synchronization with the game circuitry.

COMPOSITE VIDEO

Complete video signal from the game system to drive the display circuitry, usually comprising H SYNC, V SYNC, and the video.

CREDIT

One play for one person based on the game switch settings.

CRT

Cathode-ray tube.

DATA

General term for the numbers, letters, and symbols that serve as input for device processing.

DARLINGTON

A two-transistor amplifier that provides extremely high gain.

DC

Direct current, meaning current flowing in one direction and of a fixed value.

DEFLECTION YOKE

Electromagnetic coils around the neck of a cathode-ray tube. One set of coils deflects

the electron beam horizontally and the other set deflects the beam vertically.

DIAGNOSTICS

A programmed routine for checking circuitry. For example: the self-test is a diagnostic routine.

DIODE

A semiconductor device that conducts in only one direction.

DISCRETE

Non-integrated components, such as resistors, capacitors, and transistors.

DMA

Direct memory access. DMA is a process of accessing memory that bypasses the microprocessor logic. DMA is normally used for transferring data between the input/output ports and memory.

DOWN TIME

The period during which a game is malfunctioning or not operating correctly due to machine failure.

EAROM

Electrically alterable read-only memory (see ROM). The EAROM is a memory that can be changed by the application of high voltage.

FLYBACK

A step-up transformer used in a display to provide the high voltage.

GATE

1. A circuit with one output that responds only when a certain combination of pulses is present at the inputs.
2. A circuit in which one signal switches another signal on and off.
3. To control the passage of a pulse or signal.

HARNESS

A prefabricated assembly of insulated wires and terminals ready to be attached to a piece of equipment.

HEXADECIMAL

A number system using the equivalent of the decimal number 16 as a base. The symbols 0-9 and A-F are usually used.

IMPLODE

To burst inward; the inward collapse of a vacuum tube.

I/O

Input/Output.

IRQ

Interrupt request. IRQ is a control signal to the microprocessor that is generated by external logic. This signal tells the microprocessor that external logic needs attention. Depending on the program, the processor may or may not respond.

LED

The abbreviation for a light-emitting diode.

LOCKOUT COIL

Directs coins into the coin return box when there is no power to the game.

LOGIC STATE

The binary (1 or 0) value at the node of a logic element or integrated circuit during a particular time. Also called the logic level. The list below shows the voltage levels corresponding to the logic states (levels) in a TTL system.

Logic 0, Low = 0 VDC to +0.8 VDC

Grey Area (Tri-State Level) =

+0.8 VDC to +2.4 VDC

Logic 1, High = +2.4 VDC to +5 VDC

MULTIPLEXER

A device that takes several low-speed inputs and combines them into one high-speed data stream for simultaneous transmission on a single line.

NMI

Non-maskable interrupt. NMI is a request for service by the microprocessor from external logic. The microprocessor cannot ignore this interrupt request.

PAGE

A subsection of memory. A read-only memory device (see ROM) is broken into discrete blocks of data. These blocks are called pages. Each block has X number of bytes.

PCB

The abbreviation for a printed-circuit board.

PHOTOTRANSISTOR

A transistor that is activated by an external light source.

POTENTIOMETER

1. A resistor that has a continuously moving contact which is generally mounted on a moving shaft. Used chiefly as a voltage divider. Also called a pot (slang).
2. An instrument for measuring a voltage by balancing it against a known voltage.

RAM

Random-access memory. A device for the temporary storage of data.

RASTER-SCAN DISPLAY

A display system whereby images are displayed by continuously scanning the cathode-ray tube horizontally and vertically with an electron beam. The display system controls the intensity of the electron beam.

RETRACE

In a raster-scan display, retrace is the time during which the cathode-ray tube electron beam is resetting either from right to left or from bottom to top.

RESISTOR

A device designed to have a definite amount of resistance. Used in circuits to limit current flow or to provide a voltage drop.

ROM

Read-only memory. A device for the permanent storage of data.

SIGNATURE ANALYSIS

A process of isolating digital logic faults at the component level by means of special test equipment called signature analyzers. Basically, signature analyzers (e.g., the ATARI® CAT Box) convert lengthy bit streams into four-digit hexadecimal signatures. The signature read by the analyzer at each circuit node is then compared with the known good signature for that node. This process continues until a fault is located.

TROUBLESHOOT

The process of locating and repairing a fault.

VECTOR

A line segment drawn between specific X and Y coordinates on a cathode-ray tube.

WATCHDOG

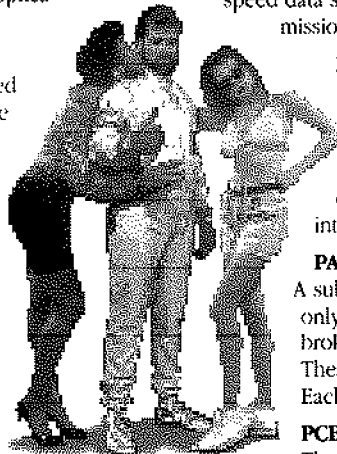
A counter circuit designed to protect the microprocessor from self-destruction if a program malfunction occurs. If a malfunction does occur, the counter applies continuous pulses to the reset line of the microprocessor, which causes the microprocessor to keep resetting.

X-Y DISPLAY

A display system whereby images are displayed with vectors.

ZENER DIODE

A special diode used as a regulator. Its main characteristic is breaking down at a specified reverse-bias (Zener) voltage.





Road Riot 4WD Kit Statistics Sheet

Date Recorded: _____ Location: _____

Meter: _____

Statistics Screen

Left Coins: _____
Right Coins: _____
Auxiliary Coins: _____
New Games: _____
Continuation: _____
Free Games: _____
Idle Time: _____
Active Time: _____
Solo Time: _____
Linked Time: _____
Error Count: _____
Total Credits: _____
Total Coins: _____
Average Time/Credit: _____
Average Time/Coin: _____



Warranty

Seller warrants that its printed-circuit boards and parts thereon are free from defects in material and workmanship under normal use and service for a period of ninety (90) days from date of shipment. Seller warrants that its video displays and laser-video disc players (in games supplied with displays and video-disc players) are free from defects in material and workmanship under normal use and service for a period of thirty (30) days from date of shipment. None of the Seller's other products or parts thereof are warranted.

If the products described in this manual fail to conform to this warranty, Seller's sole liability shall be, at its option, to repair, replace, or credit Buyer's account for such products which are returned to Seller during said warranty period, provided:

- (a) Seller is promptly notified in writing upon discovery by Buyer that said products are defective;
- (b) Such products are returned prepaid to Seller's plant; and
- (c) Seller's examination of said products discloses to Seller's satisfaction that such alleged defects existed and were not caused by accident, misuse, neglect, alteration, improper repair, installation, or improper testing.

In no event shall Seller be liable for loss of profits, loss of use, incidental or consequential damages.

Except for any express warranty set forth in a written contract between Seller and Buyer which contract supersedes the terms herein, this warranty is expressed in lieu of all other warranties expressed or implied, including the implied warranties of merchantability and fitness for a particular purpose, and of all other obligations or liabilities on the Seller's part, and it neither assumes nor authorizes any other person to assume for the Seller any other liabilities in connection with the sale of products by Seller.

The use of any non-Atari parts may void your warranty, according to the terms of the warranty. The use of any non-Atari parts may also adversely affect the safety of your game and cause injury to you and others. Be very cautious in using non-Atari-supplied components with our games, in order to ensure your safety.

Atari distributors are independent, being privately owned and operated. In their judgment they may sell parts or accessories other than Atari parts or accessories. Atari Games Corporation cannot be responsible for the quality, suitability or safety of any non-Atari part or any modification including labor which is performed by such distributor.



ATARI GAMES CORPORATION

675 Sycamore Drive

P.O. Box 361110

Milpitas, CA 95056