



*Pole Position and Pole Position II are engineered and designed by Namco Ltd., manufactured under license by Atari, Inc. © 1982, 1983. Trademark and © 1982, 1983.

Operator Information

If reading through this manual does not lead to solving a certain maintenance problem, call TELEHELP® at the Atari Customer Service office in your geographical area, as shown below.

WEST and CENTRAL U.S.A.

Parts and Service

Atari, Inc.
California Customer Service Office
737 Sycamore
P.O. Box 906
Milpitas, CA 95035
Telex 17-1103
(Monday–Friday, 7:30–4:00 pm Pacific Time)

-  From California, Alaska, or Hawaii
(408) 943-1120
-  Service from anywhere in the area shown in white
toll-free **(800) 538-1611**

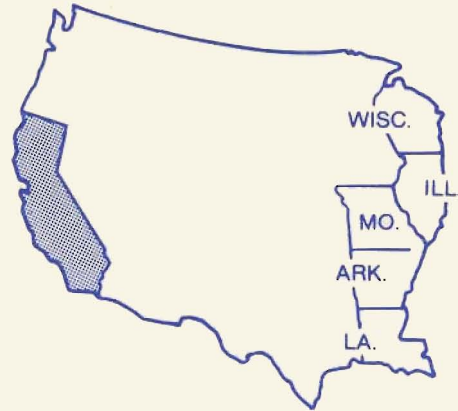

EAST U.S.A.

Service Only

Atari, Inc.
New Jersey Customer Service Office
12A World's Fair Drive, Somerset, NJ 08873
Telex 37-9347
(Monday–Friday, 7:30–4:00 p.m. Eastern time)

-  From New Jersey
(201) 469-5993
-  From anywhere else in this area
toll-free **(800) 526-3849**



Europe

Parts and Service

Atari Ireland Limited
European Customer Service Office
Tipperary Town, Ireland
Telex 28165
(Monday–Friday, 9:00–6:00 pm GMT)

-  **062-52155**





POLE POSITION II

Operators Manual

*Pole Position and Pole Position II are engineered and designed by Namco Ltd., manufactured under license by Atari, Inc. © 1982, 1983. Trademark and © 1982, 1983.

Safety Summary

The following safety precautions apply to all game operators and service personnel. Specific warnings and cautions will be found throughout this manual where they apply.

WARNINGS

Properly Ground the Game. Players may receive an electrical shock if this game is not properly grounded! To avoid electrical shock, do not plug in the game until it has been inspected and properly grounded. This game should only be plugged into a grounded 3-wire outlet. If you have only a 2-wire outlet, we recommend you hire a licensed electrician to install a grounded outlet. Players may receive an electrical shock if the control panel is not properly grounded! After servicing any parts on the panel, check that the grounding clip is firmly secured to the metal tab on the inside of the control panel. Only then should you lock up the game.

AC Power Connection. Before connecting the game to the AC power source, verify that the proper voltage-selection plug is installed on the game's power supply.

Disconnect Power During Repairs. To avoid electrical shock, disconnect the game from the AC power source before removing or repairing any part of the game. When removing or repairing the video display, extra precautions must be taken to avoid electrical shock because high voltages may exist within the display circuitry and cathode-ray tube (CRT) even after power has been disconnected. Do not touch internal parts of the display with your hands or metal objects! Always discharge the high voltage from the CRT before servicing this area of the game. To discharge the CRT: Attach one end of a large, well-insulated, 20-kV jumper to ground. Momentarily touch the free end of the grounded jumper to the anode by sliding it under the anode cap. Wait two minutes and discharge the anode again.

Use Only ATARI Parts. To maintain the safety integrity of your ATARI game, do not use non-ATARI parts when repairing the game. Use of non-ATARI parts or other modifications to the game circuitry may adversely affect the safety of your game, and injure you or your players.

Handle Fluorescent Tube and CRT With Care. If you drop a fluorescent tube or CRT and it breaks, it may implode! Shattered glass can fly six feet or more from the implosion.

Use the Proper Fuses. To avoid electrical shock, use replacement fuses which are specified in the parts list for this game. Replacement fuses must match those replaced in fuse type, voltage rating, and current rating. In addition, the fuse cover must be in place during game operation.

CAUTION

Properly Attach All Connectors. Make sure that the connectors on each printed-circuit board (PCB) are properly plugged in. Note that they are keyed to fit only one way. If they do not slip on easily, do not force them. A reversed connector may damage your game and void the warranty.

© 1983 by Atari, Inc.

All rights reserved.

No part of this publication may be reproduced by any mechanical, photographic, or electronic process, or in the form of a phonographic recording, nor may it be stored in a retrieval system, transmitted, or otherwise copied for public or private use, without permission from the publisher.

The game play, all graphic designs, this technical manual, its accompanying schematic diagrams, and the display manual are protected by the U.S. Copyright Act of 1976.

This Act provides for increased penalties for violating federal copyright laws. Courts *can impound* infringing articles while legal action is pending. If infringers are convicted, courts can *order destruction* of the infringing articles.

In addition, the Act provides for payment of statutory damages of up to \$250,000 in certain cases. Infringers may also have to pay costs and attorneys' fees and face an imprisonment of up to five years.

Atari will aggressively enforce its copyrights against any infringers. *We will use all legal means* to immediately halt any manufacture, distribution, or operation of a copy of video games made by us. Anyone who purchases such copies risks forfeiting such a game.

Published by: ATARI, INC.
790 Sycamore Drive
PO. Box 906
Milpitas, California 95035

Printed in the U.S.A. **11M**

Notice Regarding Non-ATARI Parts

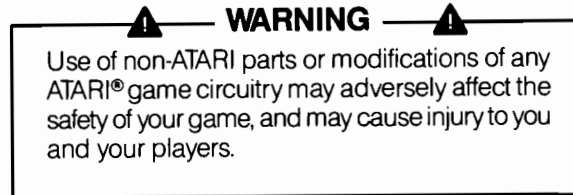

You may void the game warranty (printed on the inside back cover of this manual) if you do any of the following:

- Substitute non-ATARI parts in the game.
- Modify or alter any circuits in the game by using kits or parts *not* supplied by Atari.

NOTE

This equipment generates, uses, and can radiate radio frequency energy and if not installed and used in accordance with the instruction manual, may cause interference to radio communications. It has been tested and found to comply with the limits for a Class A computing device pursuant to Subpart J of Part 15 of Federal Communications Commission (FCC) Rules, which are designed to provide reasonable protection against such interference when operated in a commercial environment. Operation of this equipment in a residential area or modification to this equipment is likely to cause interference in which case the user, at his own expense, will be required to take whatever measures may be required to correct the interference. If you suspect interference from an ATARI® game at your location, check the following:

- All green ground wires in the game are properly connected as shown in the game wiring diagram.
- The power cord is properly plugged into a grounded three-wire outlet.
- The game printed-circuit boards (PCB) are properly installed within the Electromagnetic Interference (EMI) cage.
- The EMI Shield PCB is properly installed and connected in series with the game PCB harness.
- All filter capacitors required on the EMI Shield PCB are properly soldered in place.

If you are still unable to solve the interference problem, please contact ATARI Customer Service. See the inside front cover of this manual for service in your area.

Table of Contents

1	Set-Up	
	A. New Features	1-4
	B. Inspecting the Game	1-4
	C. Switch Locations	1-4
	1. Power On/Off Switch	1-4
	2. Utility Panel Switches	1-4
	3. Option Switches	1-4
	D. Option Switch Settings	1-6
	E. Game Play	1-11
	1. Attract Mode	1-11
	2. Play Mode	1-12
	3. High-Score Mode	1-12
	4. Hints for Game Play	1-12
	5. Scoring	1-12
2	Self-Test	
	A. Comments on Troubleshooting	2-2
	B. Self-Test Procedure	2-3
3	Parts Lists	
	Cabinet-Mounted Assemblies—Upright	3-2
	Cabinet-Mounted Assemblies—Sit-Down	3-5
	Fluorescent Tube and Speaker	3-9
	Printed-Circuit Board Hardware	3-10
	Central Processing Unit PCB Assembly—Atari	3-11
	Central Processing Unit PCB Assembly—Namco	3-18
	Video PCB Assembly—Atari	3-25
	Video PCB Assembly—Namco	3-30
4	Schematic Package Changes	4-1

List of Illustrations

Figure 1-1	Game Overview—Upright Cabinet	1-2
Figure 1-2	Game Overview—Sit-down Cabinet	1-3
Figure 1-3	Switch Locations	1-5
Figure 2-1	Self Test Screen 1: Upright Test Passes	2-3
Figure 2-2	Self Test Screen 1: Sit-Down Test Passes	2-3
Figure 2-3	Self Test Screen 1: Test Fails	2-4
Figure 2-4	Self-Test Screen—Explanation of Prompts	2-6
Figure 2-5	Self Test Screen 2: Crosshatch	2-6
Figure 3-1	Cabinet-Mounted Assemblies, Upright Cabinet	3-2
Figure 3-2	Cabinet-Mounted Assemblies, Sit-Down Cabinet	3-5
Figure 3-3	Fluorescent Tube and Speaker Board Assembly	3-9
Figure 3-4	Printed-Circuit Board Hardware	3-10

List of Tables

Table 1-1	Pole Position and Pole Position II Part Number Comparison	1-6
Table 1-2	Switch Settings for Play Options	1-7
Table 1-3	Switch Settings for Price and Special Play Options	1-8
Table 1-4	Qualifying Lap Times and Bonus Points	1-9
Table 1-5	Switch Settings for Racing Lap Times	1-10
Table 2-1	Component Locations on the Atari Video PCB	2-2
Table 2-2	Component Locations on the Atari CPU PCB	2-2
Table 2-3	Component Locations on the Namco Video PCB	2-2
Table 2-4	Component Locations on the Namco CPU PCB	2-3
Table 2-5	ROM Locations (Atari and Namco)	2-4
Table 2-6	RAM Locations (Atari)	2-4
Table 2-7	RAM Locations (Namco)	2-5
Table 4-1	SP-218 Schematic Package Changes	4-2
Table 4-2	SP-219 Schematic Package Changes	4-2

1 Set-Up Procedures

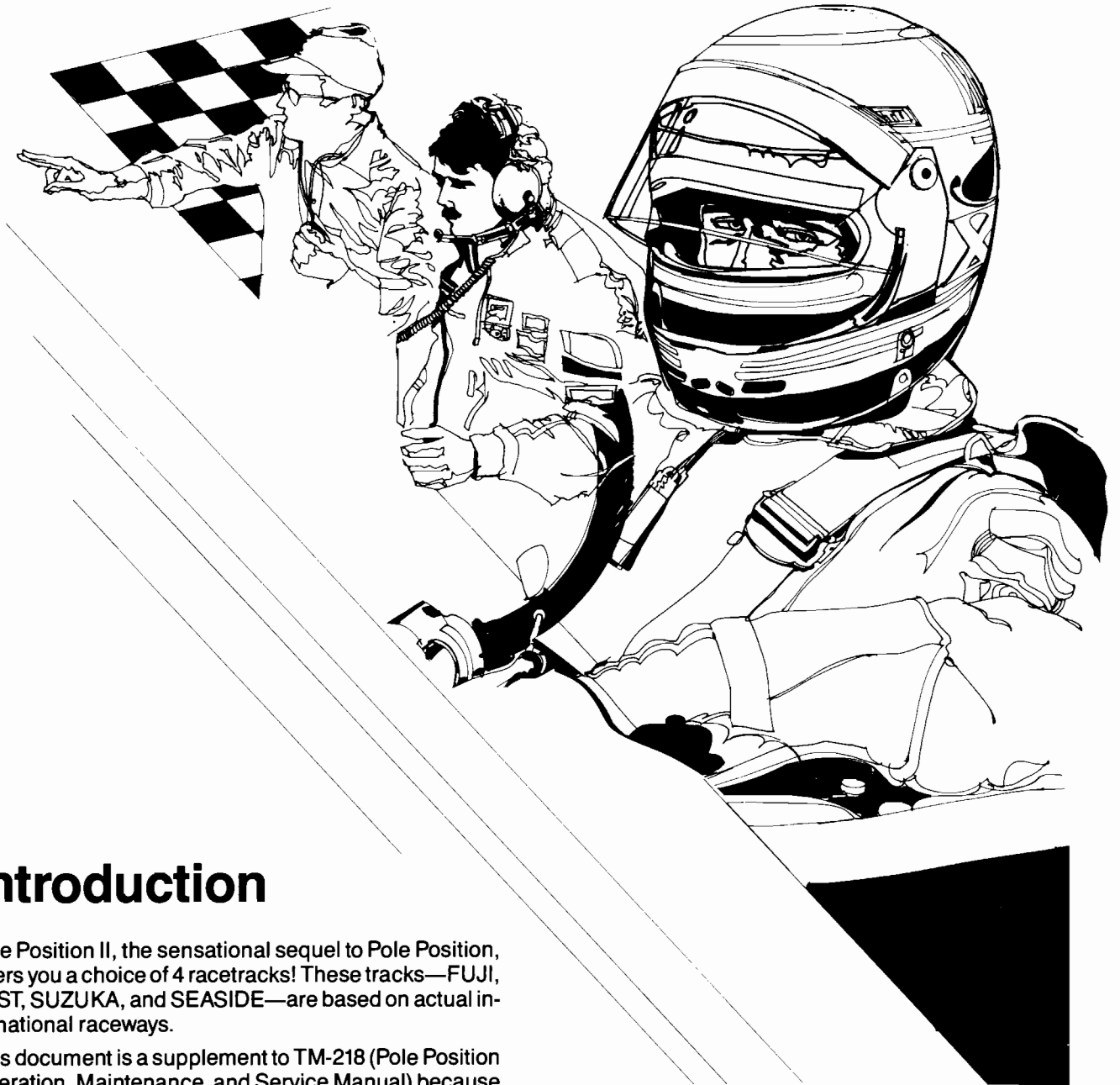

Introduction

Pole Position II, the sensational sequel to Pole Position, offers you a choice of 4 racetracks! These tracks—FUJI, TEST, SUZUKA, and SEASIDE—are based on actual international raceways.

This document is a supplement to TM-218 (Pole Position Operation, Maintenance, and Service Manual) because the Pole Position II cabinets are very similar to the Pole Position cabinets. Part numbers that are different between the two games are listed in Table 1-1.

Information about game play, option-switch settings, self-test procedures, printed-circuit boards (PCB), and part numbers for Pole Position II is contained in this document. We also describe how to change the Pole Position Schematic Package (SP-218 or SP-219) to support Pole Position II. If you need more information, refer to TM-218.

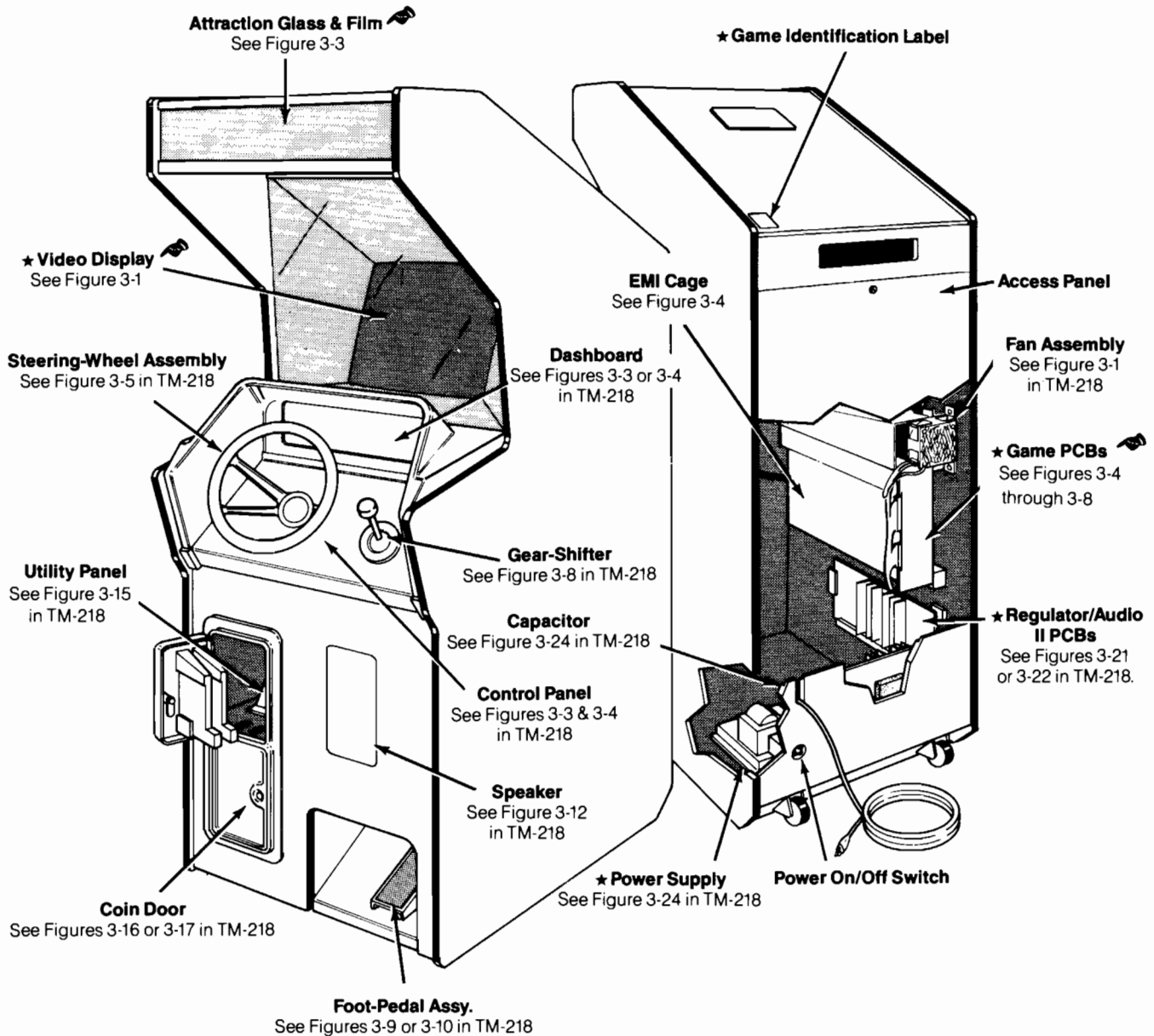

★ Items with a serial number label on U.S.-Built cabinets

WARNING

Connect this game ONLY to a grounded 3-wire outlet. If you have a 2-wire outlet, we recommend you hire a licensed electrician to install a grounded outlet. You may receive an electrical shock if the game is not properly grounded!

Figure 1-1 Game Overview—Upright Pole Position II

- ★ Game Identification Label
- ★ Items with a serial number label

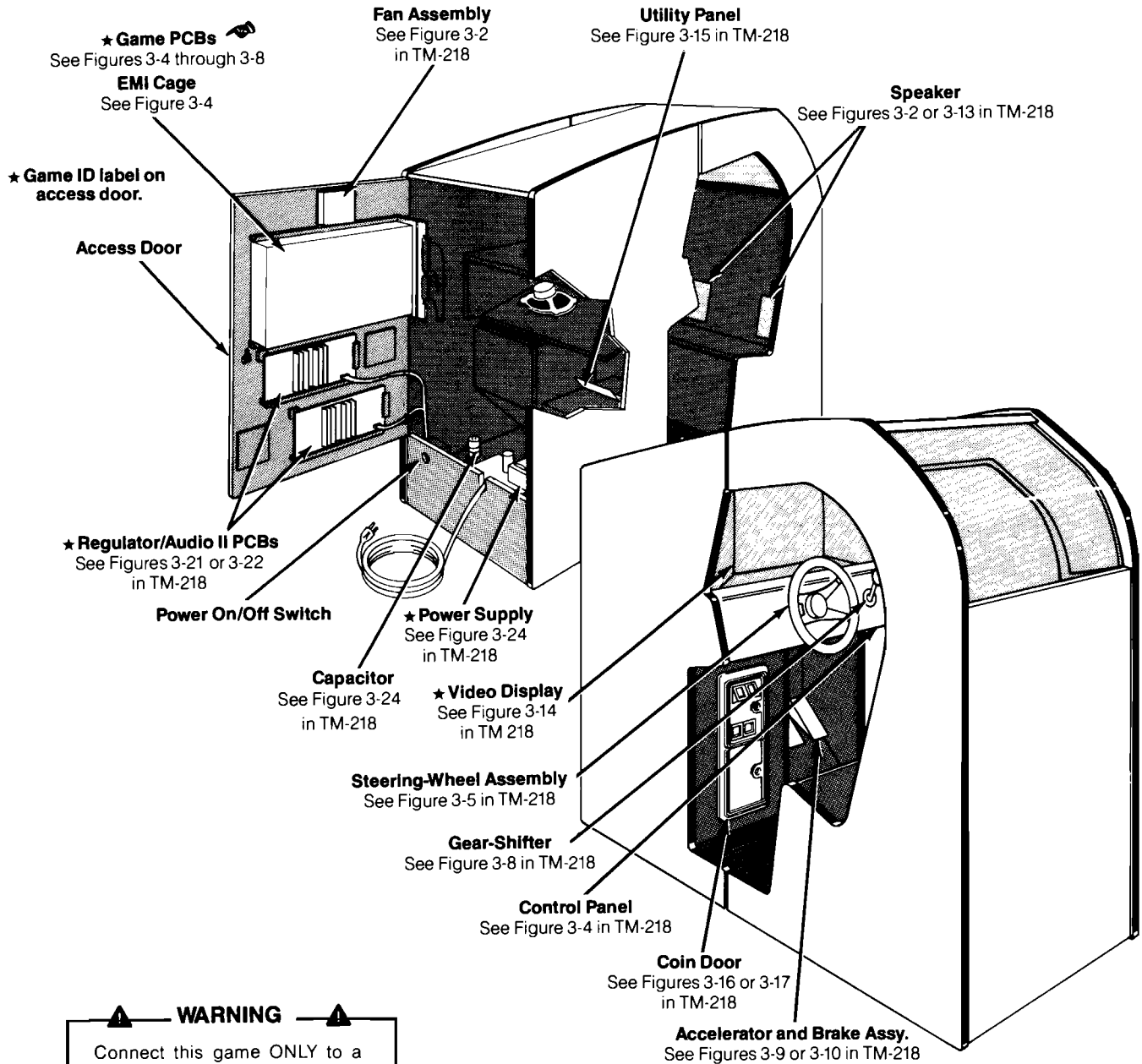

WARNING

Connect this game ONLY to a grounded 3-wire outlet. If you have a 2-wire outlet, we recommend you hire a licensed electrician to install a grounded outlet. You may receive an electrical shock if the game is not properly grounded!

Figure 1-2 Game Overview—Sit-Down Pole Position II

A. New Features

Pole Position II has several new features:

- Pole Position II presents a choice of 4 racetracks—FUJI, TEST, SUZUKA, and SEASIDE. Each track offers the player a unique challenge and different racing times.
- Faster game play—the times listed in Table 1-5 in this document are faster than the times listed in Table 1-6 in TM-218. **The time displayed on the screen is not in real seconds but “game” seconds.**
- The option-switch settings for Pole Position II are different than the Pole Position settings. For complete listings of the option-switch settings, refer to Tables 1-2 through 1-6.

CAUTION

Do not set toggle 8 of the option switch at location 9JA (Atari PCB) or 7E (Namco PCB) to on! The on setting causes the screen image to freeze. If the image is frozen for a long time, phosphor burn may occur.

WARNING

Connect this game **ONLY** to a grounded 3-wire outlet. If you have a 2-wire outlet, we recommend you hire a licensed electrician to install a grounded outlet. You may receive an electrical shock if the game is not properly grounded!

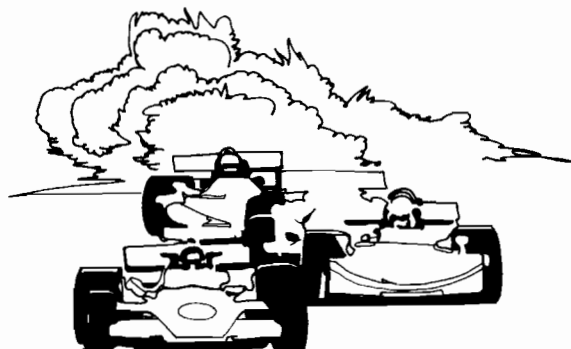

B. Inspecting the Game

Inspect your game carefully to ensure that it was delivered to you in good condition. Game inspection and setup procedures are listed in TM-218, Sections B, C, and D.

WARNING

Do not plug in the game until the procedures in Sections B, C, and D in TM-218 have been completed.

After you have completed these procedures, connect this game **ONLY** to a grounded 3-wire outlet. If you have a 2-wire outlet, we recommend you hire a licensed electrician to install a grounded outlet. You may receive an electrical shock if the game is not properly grounded.

CAUTION

Do not depress the accelerator or brake pedal when you turn on the game or switch to the Self-Test Mode. Doing so will cause faulty program initialization and incorrect action of the player controls.

C. Switch Locations

1. Power On/Off Switch

The on/off switch is behind the game on the lower left side (see Figure 1-3).

2. Utility Panel Switches

The volume control(s), self-test switch, coin counter(s), and auxiliary coin switch are located on the utility panel. The utility panel is located inside the upper coin door. The volume control adjusts the level of sound produced by the game. The Upright cabinet has two volume controls: one for each speaker. The Sit-Down cabinet has four volume controls: one for each speaker. The self-test switch is used to enter and exit the Self-Test diagnostic routine. The coin counter(s) records the number of coins entered into the game. The auxiliary coin switch is used to credit the game without activating the coin counter(s). See Figure 3-15 in TM-218 for more information about the utility panel.

3. Option Switches

If your game has Atari PCBs, the option switches are at locations 9L and 9JA on the CPU PCB. If your game has Namco PCBs, the option switches are at locations 7E and 9E on the CPU PCB (see Figure 1-3).

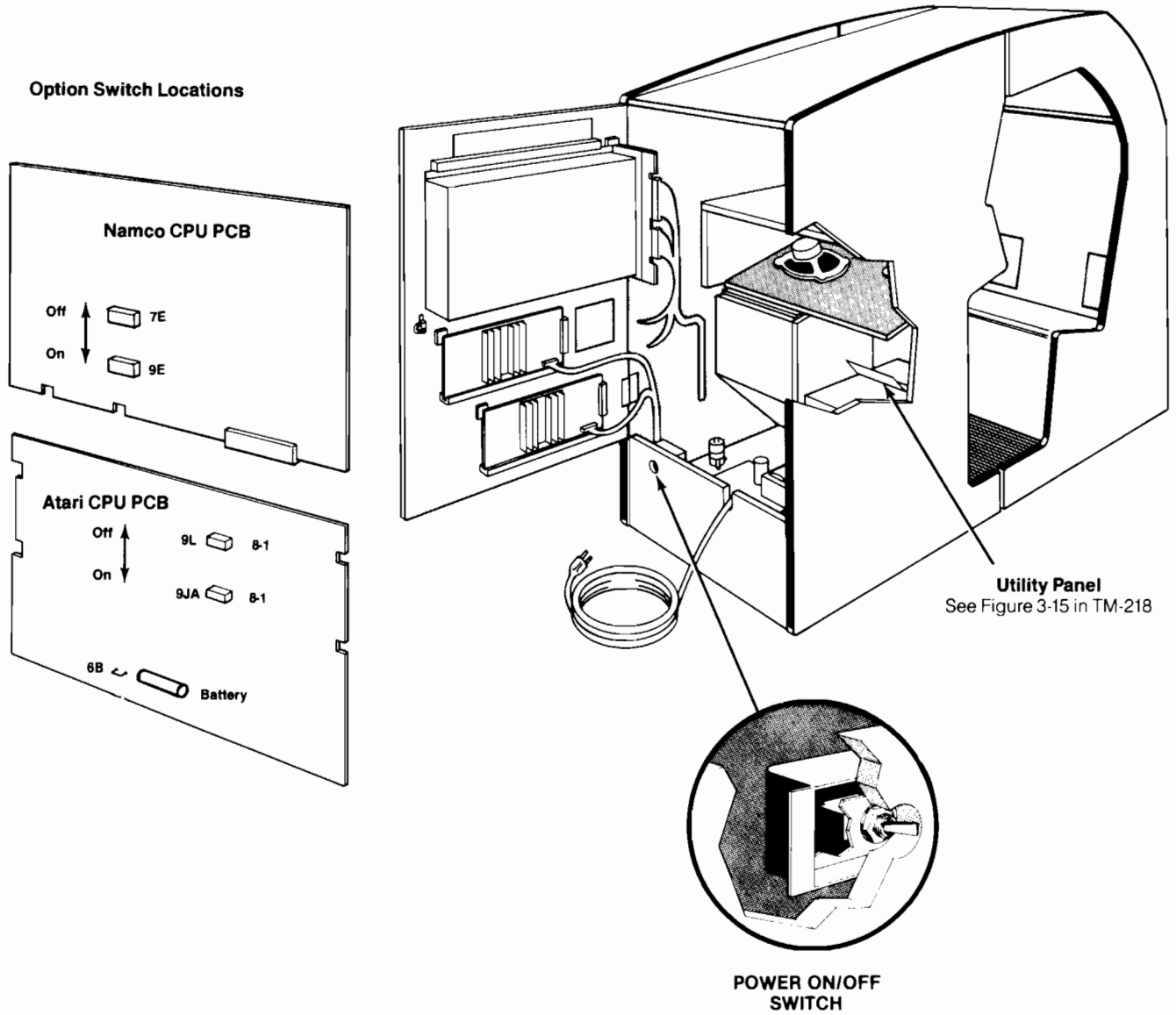

Figure 1-3 Switch Locations

Table 1-1 Comparison of Pole Position and Pole Position II Part Numbers

Description of Item	Type of Cabinet	Pole Position Part Number	Pole Position II Part Number
Self-Test Chart	Upright and Sit-Down	ST-218-01	ST-255
CPU PCB (Atari)	Upright and Sit-Down	A039185-21	A039185-22
Video PCB (Atari)	Upright and Sit-Down	A039187-21	A039187-22
CPU PCB (Namco)	Upright and Sit-Down	171031-001	171031-001
Video PCB (Namco)	Upright and Sit-Down	171032-001	171032-001
PCB Label (for CPU and Video PCB)	Upright and Sit-Down	Not Required	041377-01
Left Side Panel Decal	Upright	*	041353-01
Right Side Panel Decal	Upright	*	041353-02
Instrument Panel Decal	Upright	*	041355-03
Attraction Panel Film	Upright	039485-03	041354-02
Attraction Glass	Upright	037410-01	037410-01
Foam Tape (for attraction glass)	Upright	78-6900404	78-6900404
Video Display Shield with Graphics	Upright	039417-01	041356-01
Left Side Panel Decal—Rear	Sit-Down	*	041378-01
Right Side Panel Decal—Rear	Sit-Down	*	041378-02
Left Side Panel Decal—Front	Sit-Down	*	041379-01
Right Side Panel Decal—Front	Sit-Down	*	041379-02
Left Control Panel Decal	Sit-Down	*	041380-04
Right Control Panel Decal	Sit-Down	*	041380-05
Front Panel Decal	Sit-Down	*	041382-01
Foam Tape (for display shield)	Sit-Down	78-6900804	78-6900404
Video Display Shield with Graphics	Sit-Down	039148-01	041381-01

*Pole Position did not have decals because its panels were silkscreened.

D. Option-Switch Settings

Tables 1-2 through 1-5 explain options and switch settings. Options preset at the factory are shown by the ◀ symbols. But you may change the settings to suit your needs.

Table 1-2 lists switch settings for options relating to racing difficulty levels (A is easiest; D is hardest). It also lists settings for laps per game, preliminary game time, and speed.

Table 1-3 describes the switch settings for options relating to game pricing (coin mechanism* multipliers), unit of speed (MPH or KPH), attract mode sound, and freezing the screen.

Table 1-4 provides qualifying lap times and bonus point information.

* A coin mechanism is a device on the inside of the coin door that inspects a coin to determine if the correct coin has been inserted. The mechanism either accepts or rejects the coin. The coin door has two coin mechanisms. The multipliers (9JA switches 1-5) determine the value of the coin mechanisms to the game's logic. The basic unit of measurement is a coin worth \$.25 or 1 DM, which equals a multiplier of $\times 1$. For example, if you have a 2 DM/1 DM coin door, you may want to set the left multiplier at $\times 2$ and the right multiplier at $\times 1$.

Table 1-5 provides racing lap times for extended laps.

NOTE

Game and price options are at location 9JA on the Atari CPU PCB and 7E on the Namco CPU PCB. Game and play options are at location 9L on the Atari CPU PCB and 9E on the Namco CPU PCB.

To verify option-switch settings, set the self-test switch to the on position. Compare the information on the screen (see Figure 2-1 for an explanation of messages on the screen) to the option-switch settings listed in the tables in this section. If these settings are the ones you want, set the self-test switch to the off position. If you want to change settings, set the self-test switch to off, set the power on/off switch to off, and change the switch settings.

Pole Position II leaves the factory with option switches set at the manufacturer's recommended difficulty level. The game will be exciting and challenging for players at these settings.

NOTE

Table 1-2 contains average and high speed settings. The average speed setting enables the game to reach top speeds of 458 KPH (286 MPH); however, due to the varying difficulty of different tracks, the typical top speed will be 411 KPH (256 MPH). The high speed setting enables the game to reach top speeds of 582 KPH (363 MPH); however, due to the varying difficulty of different tracks, the typical top speed will be 450 KPH (280 MPH).

NOTE

Atari, Inc. tested the Upright game and found that, in an arcade environment, earnings will be excellent with option switches set to Sit-Down game settings.

Table 1-2 Switch Settings for Play Options

Settings of 8-Toggle Switch on Pole Position II PCB (location 9L or 9E)

1	2	3	4	5	6	7	8	Option
Off								Preliminary Game Time
On								90 seconds ★
								120 seconds ◀
	On	Off						Preliminary Rank
	Off	Off						A
	Off	On						B ◀ ★
	On	On						C
								D
			On	Off				Extended Rank
			Off	Off				A
			Off	On				B ◀ ★
			On	On				C
								D
					On	Off		Number of Laps
					Off	Off		3
					Off	On		4 ★
					On	On		5 ◀
					On	On		6
							Off	Speed
							On	Average speed
								High Speed ◀ ★

◀ Manufacturer's recommended settings for Sit-Down
 ★ Manufacturer's recommended settings for Upright

Table 1-3 Switch Settings for Price and Special Play Options

Settings of 8-Toggle Switch on Pole Position II PCB (location 9JA or 7E)								Option
1	2	3	4	5	6	7	8*	
Off	Off	Off						Left Coin Mechanism
On	Off	Off						1 coin for 1 credit ★
Off	On	Off						1 coin for 2 credits
On	On	Off						1 coin for 3 credits
								2 coins for 1 credit ◀
Off	Off	On						3 coins for 1 credit
On	Off	On						3 coins for 2 credits
Off	On	On						4 coins for 3 credits
On	On	On						Free Play
								Right Coin Mechanism
			Off	Off				1 coin for 1 credit ★
			On	Off				2 coins for 1 credit ◀
			Off	On				3 coins for 2 credits
			On	On				1 coin for 6 credits
								Unit of Speed
					Off			Kilometers per hour
					On			Miles per hour ◀ ★
								Attract Mode Sound
						Off		Sound ◀ ★
						On		Silence
								Screen Freeze
							Off	Normal Action ◀ ★
							On	Freeze

◀ Manufacturer's recommended settings for Sit-Down

* Do not turn switch 8 on!

★ Manufacturer's recommended settings for Upright

Table 1-4 Qualifying Lap Times and Bonus Points

Seconds to Qualify																	
Fuji Track				Test Track				Suzuka Track				Seaside Track				Position	Bonus Points
A	B	C	D	A	B	C	D	A	B	C	D	A	B	C	D		
56	55	54.5	54	54	53	52.5	52	55	54	53.5	53	58	57	56.5	56	Pole	4000
58	57	56.5	56	56	55	54.5	54	57	56	55.5	55	60	59	58.5	58	2	2000
60	59	58.5	58	58	57	56.5	56	59	58	57.5	57	62	61	60.5	60	3	1400
62	61	60.5	60	60	59	58.5	58	61	60	59.5	59	64	63	62.5	62	4	1000
64	63	62.5	62	62	61	60.5	60	63	62	61.5	61	66	65	64.5	64	5	800
66	65	64.5	64	64	63	62.5	62	65	64	63.5	63	68	67	66.5	66	6	600
68	67	66.5	66	66	65	64.5	64	67	66	65.5	65	70	69	68.5	68	7	400
70	69	68.5	68	68	67	66.5	66	69	68	67.5	67	72	71	70.5	70	8	200

◀Manufacturer's recommended settings.

Table 1-5 Switch Settings for Racing Lap Times

Track	Number of Laps ¹	Extended Rank	Race Lap ²	Number of Game Seconds For Each Extended Lap				
				Lap 1	Lap 2	Lap 3	Lap 4	Lap 5
FUJI	3	A	80	43	57			
	3	B◀	75	46	56			
	3	C	75	44	55			
	3	D	75	42	54			
	4	A	80	46	57	57		
	4	B◀	75	56	56			
	4	C	75	47	55	55		
	4	D	75	45	54	54		
	5	A	80	46	58	58	58	
	5	B◀	75	49	57	57	57	
	5	C	75	47	56	56	56	
	5	D	75	45	55	55	55	
	6	A	80	46	58	58	58	60
	6	B◀	75	49	57	57	57	59
	6	C	75	47	56	56	56	58
	6	D	75	45	55	55	55	57
TEST	3	A	80	39	55			
	3	B◀	75	42	54			
	3	C	75	40	53			
	3	D	75	38	52			
	4	A	80	42	54	54		
	4	B◀	75	43	53	53		
	4	C	75	43	53	53		
	4	D	75	41	52	52		
	5	A	80	42	56	56	56	
	5	B◀	75	45	55	55	55	
	5	C	75	43	54	54	54	
	5	D	75	41	53	53	53	
	6	A	80	42	56	56	56	58
	6	B◀	75	44	55	55	55	57
	6	C	75	43	54	54	54	56
	6	D	75	41	53	53	53	55
SUZUKA	3	A	80	43	57			
	3	B◀	75	46	56			
	3	C	75	44	55			
	3	D	75	42	54			
	4	A	80	46	57	57		
	4	B◀	75	49	56	56		
	4	C	75	47	55	55		
	4	D	75	45	54	54		
	5	A	80	46	58	58	58	
	5	B◀	75	49	57	57	57	
	5	C	75	47	56	56	56	
	5	D	75	45	55	55	55	
	6	A	80	46	58	58	58	60
	6	B◀	75	49	57	57	57	59
	6	C	75	47	56	56	56	58
	6	D	75	45	55	55	55	57

¹Number of laps is identified in Self-Test as "GOAL".

²If your racing lap time is less than the time listed, the remaining seconds are added to the next lap.

◀ Manufacturer's recommended settings.

Table 1-5 Switch Settings for Racing Lap Times, continued

Track	Number of Laps ¹	Extended Rank	Race Lap ²	Number of Game Seconds For Each Extended Lap				
				Lap 1	Lap 2	Lap 3	Lap 4	Lap 5
SEASIDE	3	B ◀	75	48	57			
	3	C	75	46	56			
	3	D	75	44	55			
	4	A	80	48	58	58		
	4	B ◀	75	51	57	57		
	4	C	75	49	56	56		
	4	D	75	47	55	55		
	5	A	80	48	59	59	59	
	5	B ◀	75	51	58	58	58	
	5	C	75	49	57	57	57	
	5	D	75	47	56	56	56	
	6	A	80	48	59	59	59	61
	6	B ◀	75	51	58	58	58	60
	6	C	75	49	57	57	57	59
	6	D	75	47	56	56	56	58

¹Number of laps is identified in Self-Test as "GOAL".

²If your racing lap time is less than the time listed, the remaining seconds are added to the next lap.

◀ Manufacturer's recommended settings.

E. Game Play

Pole Position II is a one-player game using a color raster-scan video display. Game action takes place at 4 different raceways—the Fuji Speedway in Japan, the Test Track (an oval track like Indy), the Seaside Speedway (with the Long Beach Pike in the background), and the Suzuka Speedway in Japan. The unique and picturesque scenery around each raceway adds exciting realism to each race!

The driver drives a Formula-1 race car on each track. Player controls consist of a steering wheel, a two-position gear shifter, an accelerator, and a brake pedal (on the Sit-Down cabinet). The first objective of the game is to finish the qualifying lap as quickly as possible. If the driver beats the times specified in Table 1-4, he qualifies for the race. If he does not qualify, he drives the remainder of his time along the qualifying course.

As a qualifier, the driver is ranked according to his qualifying lap time, from position one (the pole position) to position eight. Then the driver's second objective is to race against the clock and other cars to finish the race laps (operator selects the number of laps) as fast as possible, and to achieve the highest score possible. The driver earns points for passing cars, driving on the track, and finishing the race with time remaining. The time remaining from the Racing Lap is added to the extended lap time listed in Table 1-5.

Pole Position II has four modes of operation: Attract, Play, High-Score, and Self-Test. Self-Test is a special mode for checking the game controls, switches, and computer

functions. You may enter the Self-Test Mode from any other mode. However, all credits will be cancelled. See Chapter 2 for complete Self-Test information.

1. Attract Mode

The Attract Mode begins when the power on/off switch is set to *on* or after the Play, High-Score, or Self-Test Modes. The Attract Mode ends when the correct amount of credit for a game is inserted or when the Self-Test Mode begins.

The Attract Mode begins with the words "Pole Position" and "II" tumbling toward you until they stop.

Then, the Attract Mode simulates game play (one track at a time). Eight cars are at the starting line. The driver's car, located in the eighth position, flashes on the screen. The starting lights flash from red to green and the race starts. The race continues until the driver's car crashes into another car and explodes into a red ball of fire.

The message *GAME OVER* appears in the center of the screen.

Finally, the Attract Mode displays the High-Score Table. Each track has its own high-score table, and this section of the Attract Mode will display a map of the track, the name of the track, the fastest lap time of the track, and the top speed reached at that track. It will also list information about the top six scores reached at that track—the position number, the score, the time, and initials of the driver.

Pole Position II appears on the screen, and at the bottom of the screen is the copyright message.

2. Play Mode

To start the Play Mode, a driver must first enter the correct number of coin(s) for a game. Then the driver turns the steering wheel until the track he wants to drive on is highlighted in white. The Play Mode will begin when the driver steps on the accelerator. The driver's car will appear behind the starting line and 90 (or 120) seconds will be on the clock (see Table 1-2 for settings for Preliminary Game Time seconds). The car must finish the qualifying lap within the time listed in Table 1-4 to be in the race. If the driver does not qualify, his car continues on the track until 120 seconds elapse.

If the driver has qualified, just before the race begins, the driver's car (flashing on the screen) is placed at the starting line with seven other cars. The position of the car depends on the position earned during the qualifying lap.

The starting lights flash from red to green, and the race begins. Racing hazards are other racing cars, sharp turns, puddles, and road signs. As the race progresses, more cars appear on the track. If the driver's car hits another car or a road sign, the driver's car is destroyed in an explosion. The driver's car reappears in a few seconds and the race continues. Driving through wet puddles or off the track slows down the driver's car considerably.

Experience will teach a driver which turns on which tracks require slight steering (because they're banked) and which turns require fast and forceful steering. He jockeys for position with the other racers, while keeping his eye on the clock at the top of the screen. When his time runs out, the race is over. If he has beaten the racing lap time listed in Table 1-5 and has seconds remaining, the remaining seconds are added to his next lap.

The top score achieved by a driver appears at the top of the screen. The time allotted for the lap is displayed under the top score. Increasing lap time (in seconds and hundredths of a second) and the speed of the car appears last.



3. High-Score Mode

The High-Score Mode begins when the driver has earned one of the 100 highest scores. The screen will show his ranking from 1 to 100. If his score is in the top 20 scores for the track, he'll have one minute to record his initials (each track has its own high-score table). The driver rotates the steering wheel to change initials, and presses the accelerator to select the initial. The third press will enter the initials into the high-score table.

4. Hints for Game Play

- Avoid puddles and the sides of the track because these slow the driver down.
- Accelerate before the green light appears, and stay ahead of other racers.
- Drive the inside of the track to make the corners.
- Do not oversteer (tracks are banked).
- Engine sound will cue the driver when to shift to high gear.
- When sliding, steer into the skid.

5. Scoring

Points are scored for completing laps and passing cars. 10,000 points are awarded for completing a lap. Points are also scored for every foot of track driven. 200 points are awarded for each second remaining on racing laps. At the end of a game, 50 points are scored for each car the driver passes.

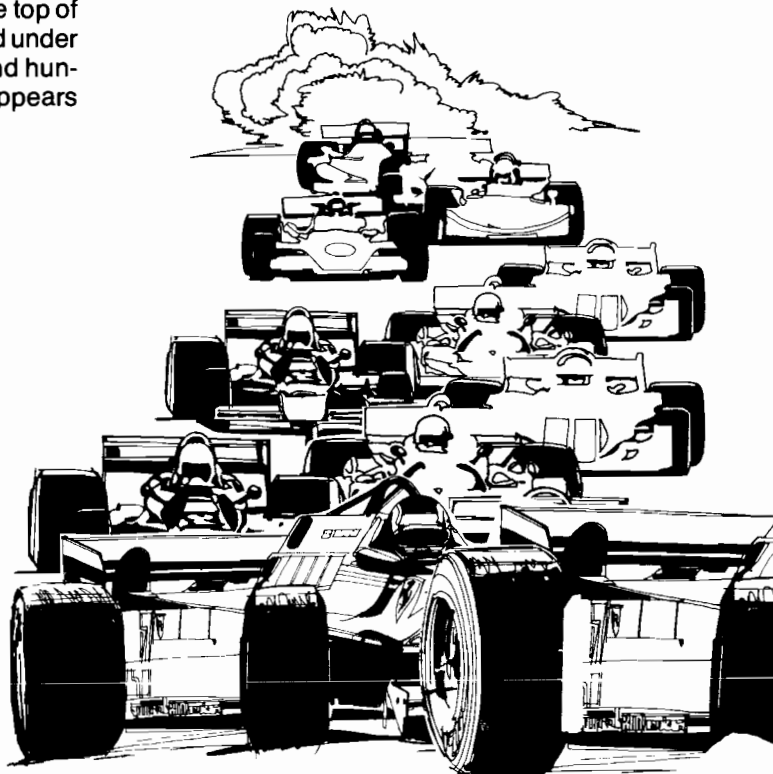

2 Self-Test

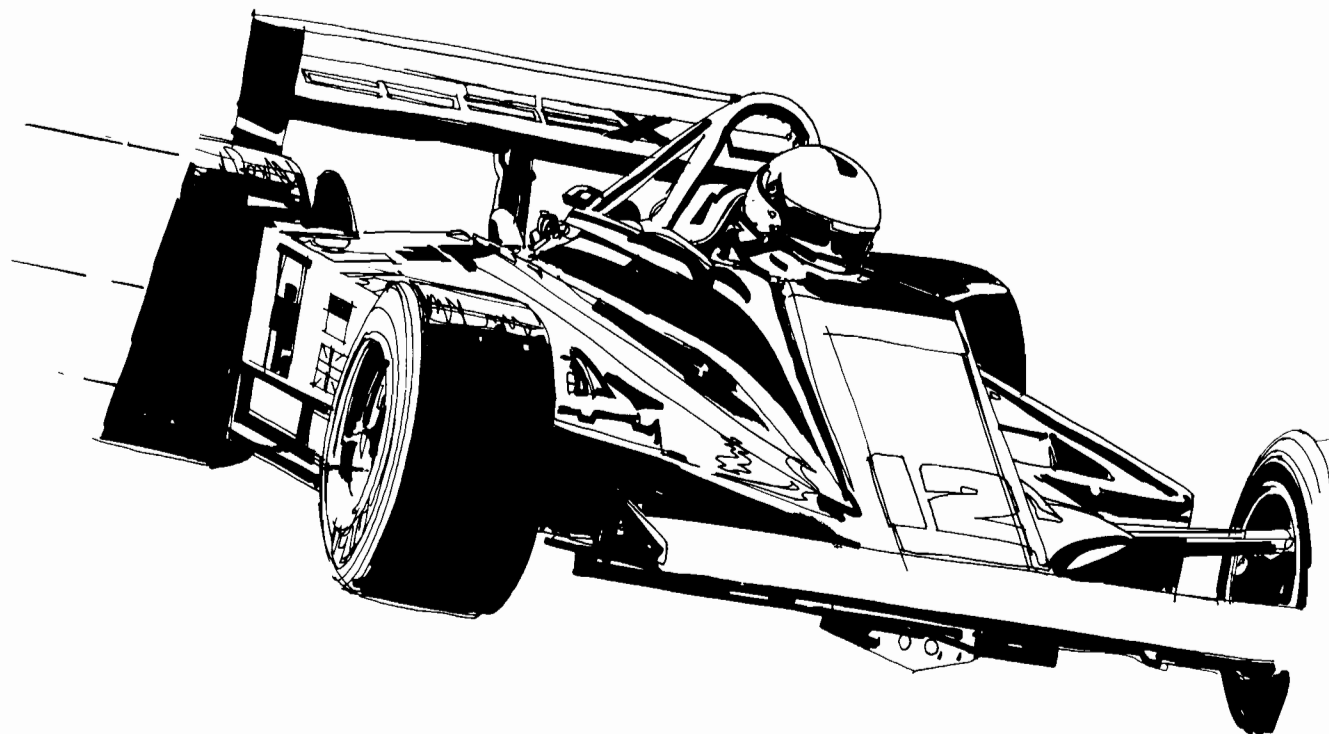
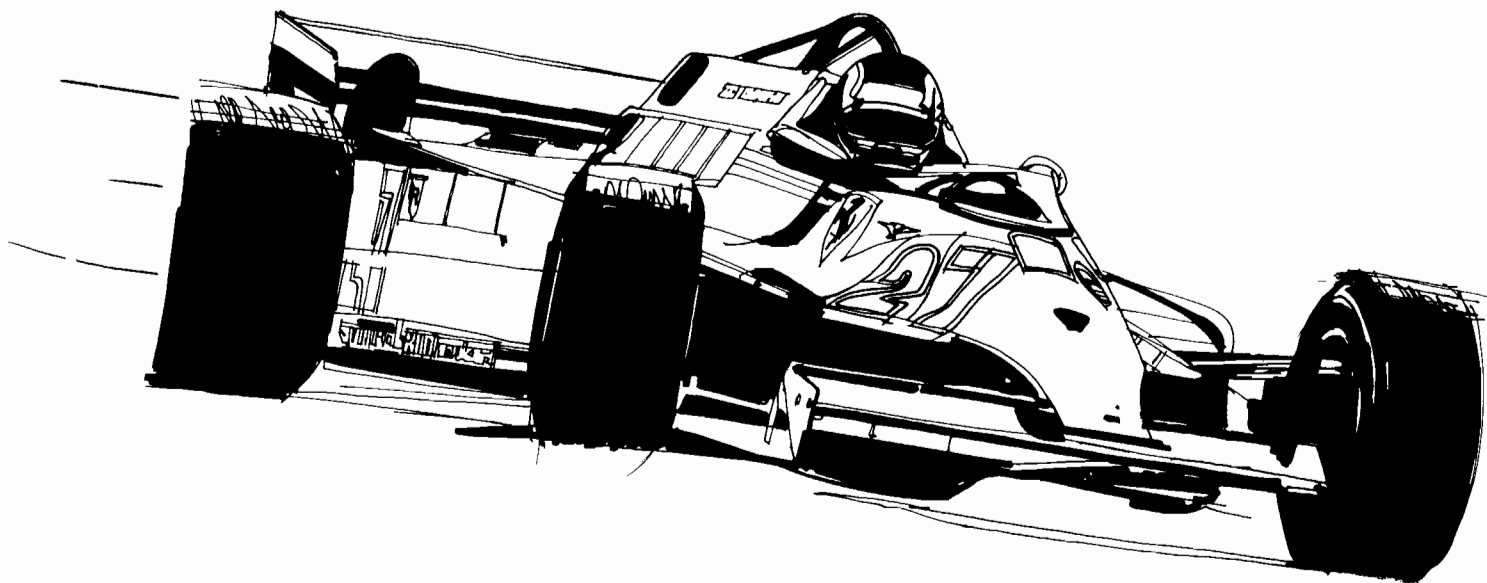

A. Comments on Troubleshooting

When troubleshooting, first determine the symptom(s) of the failure. After determining the symptom, look over the wiring diagram and determine what assemblies could cause the failure. Could it be caused by the power supply, Regulator/Audio II printed-circuit board (PCB), or the video display?

The next step is to check all harness wires and connectors to the suspected assembly. If you do not find a harness or connector problem, substitute an assembly known to be good for the suspected failing assembly. If the game functions properly, you have successfully isolated the failure. If it doesn't, repeat the procedure with another assembly.

When you have isolated the failing assembly, you must troubleshoot that assembly and make the necessary repairs. If the video display fails, we suggest that a qualified video-display technician handle the troubleshooting and repair.

Be sure to refer to *The Book—A Guide to Electronic Game Operation and Servicing*, published by Atari, Inc., whenever you need help with the techniques, tools, and terminology associated with coin-operated electronic games.

To effectively troubleshoot a game PCB, learn as much as you can about the PCB. The diagrams in the Schematic Package (SP-218 for Atari PCBs; SP-219 for Namco

Table 2-1 Component Locations on the Atari Video PCB

Symptom Area	PROM	Custom IC	RAM
Large Car Pictures		12J, 13J	
Large Sign Pictures	12K, 13K, 12L, 13L		
Small Cars & Signs	12N, 13N		
All Cars & Signs	12H, 11N	13H	9F, 10F
Alphanumerics	7N, 8M	8N	
Raceway	2L, 2M, 2N, 4L	3N	
Background	6N, 5K		
Raceway & Background		5L, 6L	
Middle & Sides of Raceway	2B, 2C, 2D		
All Video		4D, 7E, 2F	
Red	11E		
Green	11D		
Blue	11C		

Table 2-2 Component Locations on the Atari CPU PCB

Symptom Area	PROM	Custom IC	RAM	A-to-D Converter
Audio				
Voice	9C	9D		
Screech/Crash		9E		
Player's Motor	12E, 12F			
All Other Sounds	7L, 11D		7K, 7J	
Inputs				
Brake and/or Accelerator				8J
Steering		9K		
Option Switches		9K, 9M		
All Other Inputs		9M		
Control—Audio & Inputs		8H, 9H		
Sync			7M	
High Scores			7E	

Table 2-3 Component Locations on the Namco Video PCB

Symptom Area	PROM	Custom IC	RAM
Large Car Pictures	5M, 5N		
Large Sign Pictures	3M, 4M, 3N, 4N		
Small Cars & Signs	1M, 1N		
All Cars & Signs	1L, 6M	6N	7J, 7K
Alphanumerics	1F, 2H	1H	
Raceway	1A, 2A, 3A, 3C	1B	
Background	4D, 1E		
Raceway & Background			3D, 3E
Middle & Sides of Raceway	9A, 10A, 11A		
All Video			7A, 9C, 8F
Red	8L		
Green	9L		
Blue	10L		

PCBs) show the functions of the circuitry. To troubleshoot a PCB, first determine the symptom of the failure, then locate the suspected area on the schematic diagram. Tables 2-1 and 2-2 will help you locate faulty components on the Atari PCBs, and Tables 2-3 and 2-4 will help you locate faulty components on the Namco PCBs.

Table 2-4 Component Locations on the Namco CPU PCB

Symptom Area	PROM	Custom IC	RAM	A-to-D Converter
Audio				
Voice	2E	3D		
Screech/Crash		4E		
Player's Motor	5A, 6A			
All Other Sounds	3B, 9H		7H, 8H	
Inputs				
Brake and/or Accelerator				7F
Steering		8D		
Option Switches		8D, 10D		
All Other Inputs		10D		
Control—Audio & Inputs		6E, 6F		
Sync		10H		
High Scores		4H		

B. Performing the Self-Test

This game will test itself and provide data to show if the game's circuitry and controls are operating properly. This data is provided on the video display and speakers. No additional equipment is necessary.

We suggest you perform the self-test procedure when you first set up the game, when you collect money from the game, when you change game options, or when you suspect game failure.

CAUTION

If this game needs servicing, repair should only be performed by a qualified electronic technician.

Self-Test Procedure

The self-test switch is located on the utility panel inside the coin door. The option switches are on the CPU printed-circuit board (see Figure 1-3).

CAUTION

Do not depress the accelerator or brake pedal when turning on the game or when turning on the self-test switch. This will cause faulty program initialization and incorrect action of the player controls.

- Without touching the pedal(s), turn the self-test switch on. The self-test program will test the game memory (RAM and ROM). All credits will be cancelled.

Test Passes: Random symbols are displayed on the screen for about 5 seconds as RAM and ROM are tested. If the memories are good, the screen will look like Figure 2-1 or 2-2.

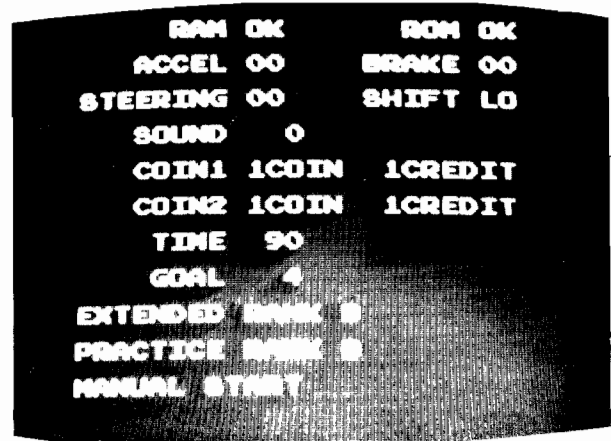

Figure 2-1 Self-Test Screen 1—Upright Test Passes

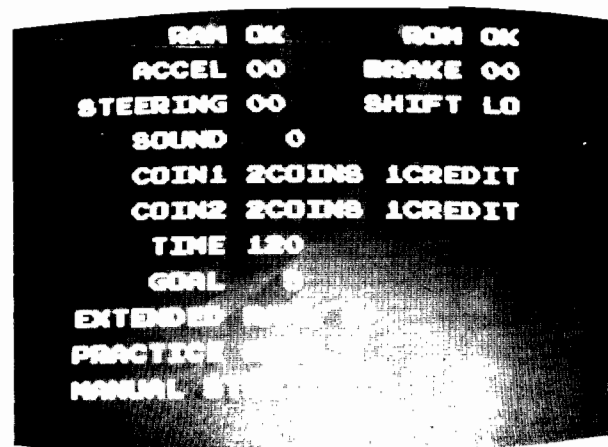
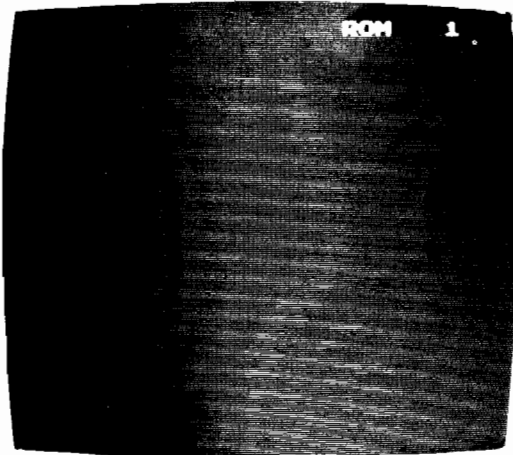

Figure 2-2 Self-Test Screen 1—Sit-Down Test Passes

Test Fails: If the Pole Position II Custom integrated circuit (IC) has failed, the screen will continue to display random symbols and colors, and the message *ERROR IC25* will be in the upper left corner. Whenever a ROM fails, its name will appear on the screen (e.g., ROM 1 failed in Figure 2-3). Use Table 2-5 to locate the ROM that the screen indicates is bad. A failed RAM will also appear on the screen. Use Table 2-6 or 2-7 to locate the RAM that the screen indicates is bad.

Action: Replace the failed RAM or ROM. Start the self-test again (turn the self-test switch off, then on.)



**Figure 2-3 Self-Test Screen 1—
Test Fails**

**Table 2-5 ROM Locations
(Atari and Namco)**

Screen Message	Location on Atari CPU PCB	Location on Namco CPU PCB
ROM 0	7H	6H
ROM 1	7F	5H
ROM 2	3L	8M
ROM 3	4L	8L
ROM 4*	3K	7M
ERROR IC25	4K	7L
ROM 6	3E	4M
ROM 7	4E	4L
ROM 8	3D	3M
ROM 9	4D	3L

*Not used

Table 2-6 RAM Locations (Atari)

PCB	Screen Display	RAM Location
Video	RAM 0	8F
Video	RAM 1	7F
Video	RAM 2	8H
Video	RAM 3	7H
Video	RAM 4	3F
Video	RAM 5	3E
CPU	RAM 6	7J
CPU	RAM 7	7K
CPU	RAM 8	7E
Video	RAM 20	8F
Video	RAM 21	7F
Video	RAM 22	8J
Video	RAM 23	7J
Video	RAM 24	8H
Video	RAM 25	7H
Video	RAM 26	8K
Video	RAM 27	7K
Video	RAM 28	3F
Video	RAM 29	4F
Video	RAM 30	3E
Video	RAM 31	4E
Video	RAM 40	8F
Video	RAM 41	7F
Video	RAM 42	8J
Video	RAM 43	7J
Video	RAM 44	8H
Video	RAM 45	7H
Video	RAM 46	8K
Video	RAM 47	7K
Video	RAM 48	3F
Video	RAM 49	4F
Video	RAM 50	3E
Video	RAM 51	4E

- Now, start testing the controls and switches. Press the accelerator pedal.

Test Passes: The numbers to the right of *ACCEL* increase from 00 to A0 as you press down on the pedal.

Test Fails: The numbers to the right of *ACCEL* do not change, or no numbers appear.

Action: Suspect a bad A-D converter on the CPU PCB or a mechanical problem on the foot pedal assembly. Troubleshoot using the information in TM-218 (Chapter 3, Section B) and the game schematics.

Table 2-7 RAM Locations (Namco)

PCB	Screen Display	RAM Location
Video	RAM 0	7H
Video	RAM 1	7F
Video	RAM 2	6H
Video	RAM 3	6F
Video	RAM 4	7B
Video	RAM 5	8B
CPU	RAM 6	7H
CPU	RAM 7	8H
CPU	RAM 8	4H
Video	RAM 20	7H
Video	RAM 21	7F
Video	RAM 22	5H
Video	RAM 23	5F
Video	RAM 24	6H
Video	RAM 25	6F
Video	RAM 26	4H
Video	RAM 27	4F
Video	RAM 28	7B
Video	RAM 29	7C
Video	RAM 30	8B
Video	RAM 31	8C
Video	RAM 40	7H
Video	RAM 41	7F
Video	RAM 42	5H
Video	RAM 43	5F
Video	RAM 44	6H
Video	RAM 45	6F
Video	RAM 46	4H
Video	RAM 47	4F
Video	RAM 48	7B
Video	RAM 49	7C
Video	RAM 50	8B
Video	RAM 51	8C

3. Press the brake pedal of the Sit-Down cabinet.

Test Passes: The numbers to the right of *BRAKE* increase from *00* to *FF*. For the Upright cabinet, the numbers to the right of *BRAKE* should always read *00*.

Test Fails: The numbers to the right of *BRAKE* do not change as you press the brake pedal. On the Upright cabinet, brake failure is indicated by anything other than *00* appearing to the right of *BRAKE*.

Action: If the test fails, suspect a bad switch, improper mechanical adjustment of the foot pedal assembly, or no ground of the brake edge-connector pin in the harness. Troubleshoot using the information in TM-218 (Chapter 3, Section B) and the game schematics.

4. Turn the steering wheel clockwise, then counterclockwise.

Test Passes: The numbers to the right of *STEERING* increase as the wheel turns clockwise and decrease as the wheel turns counterclockwise.

Test Fails: The numbers to the right of *STEERING* do not change properly as you turn the wheel.

Action: If the test fails, suspect the Coupler PCB. Troubleshoot using the information in TM-218 (Chapter 3, Section B) and the game schematics.

5. Shift the gear shifter.

Test Passes: The words to the right of *SHIFT* change from *LO* (shifter up) to *HI* (shifter down) as you shift gears.

Test Fails: Failure is indicated if the words to the right of *SHIFT* do not change from *LO* to *HI* as you shift gears.

Action: Suspect loose connector wires or a bad switch. Troubleshoot using the information in TM-218 (Chapter 3, Section B) and the game schematics.

6. To test the sounds of the game, shift the gear shift, press the auxiliary coin switch on the utility panel, and activate the coin switches.

Test Passes: The numbers to the right of *SOUND* increase from *00* to *20*, and a different sound is played with each number. Test all 20 sounds.

Test Fails: Failure is indicated by silence when the coin switches or gear shifter are activated.

Action: Make sure the volume control is turned up, or check for a loose harness or connector wire. The custom audio I/O chip or the Regulator/Audio II PCB may be bad. Troubleshoot using the game schematics.

7. To verify that the option switches are set the way you need them, and to check game statistics, press the auxiliary coin switch. The screen will display Figure 2-4.

Test Passes: Game statistics appear at the bottom of the screen. To erase game statistics, simultaneously press the accelerator pedal and press the auxiliary coin switch twice. Statistics will be reset at 999. To reset the high-score table, simultaneously press down on the accelerator pedal and shift the gear-shifter from low to high. The high-score table will be reset to contain fictitious scores.

Test Fails: Option switches are not set the way you want them.

Action: Turn the game power off. Set the option switches (see Tables 1-2 through 1-5 for possible

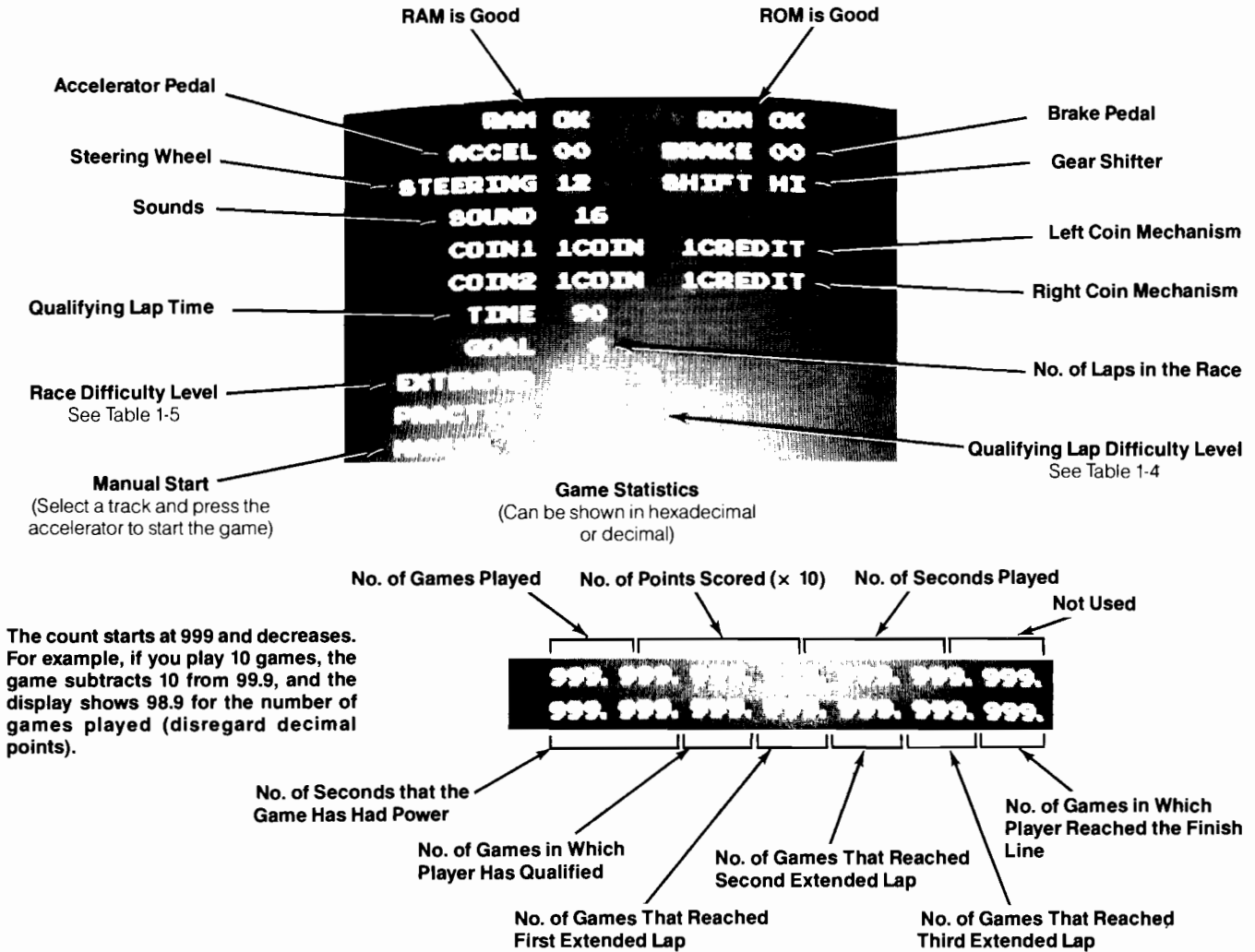

Figure 2-4 Self-Test Screen— Explanation of Prompts

options). Turn the power on. Turn the self-test switch off, then on. Verify the switch settings.

- To see self-test screen two, set the self-test switch to off and immediately back to on.

Test Passes: A white crosshatch pattern appears on the screen (see Figure 2-5). Use this pattern for convergence adjustment (see the raster-scan video display manual).

Test Fails: There is no failure for this test.

- To end the test, turn the self-test switch off.

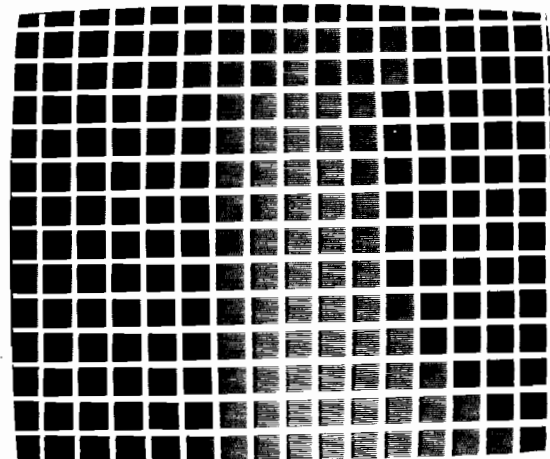
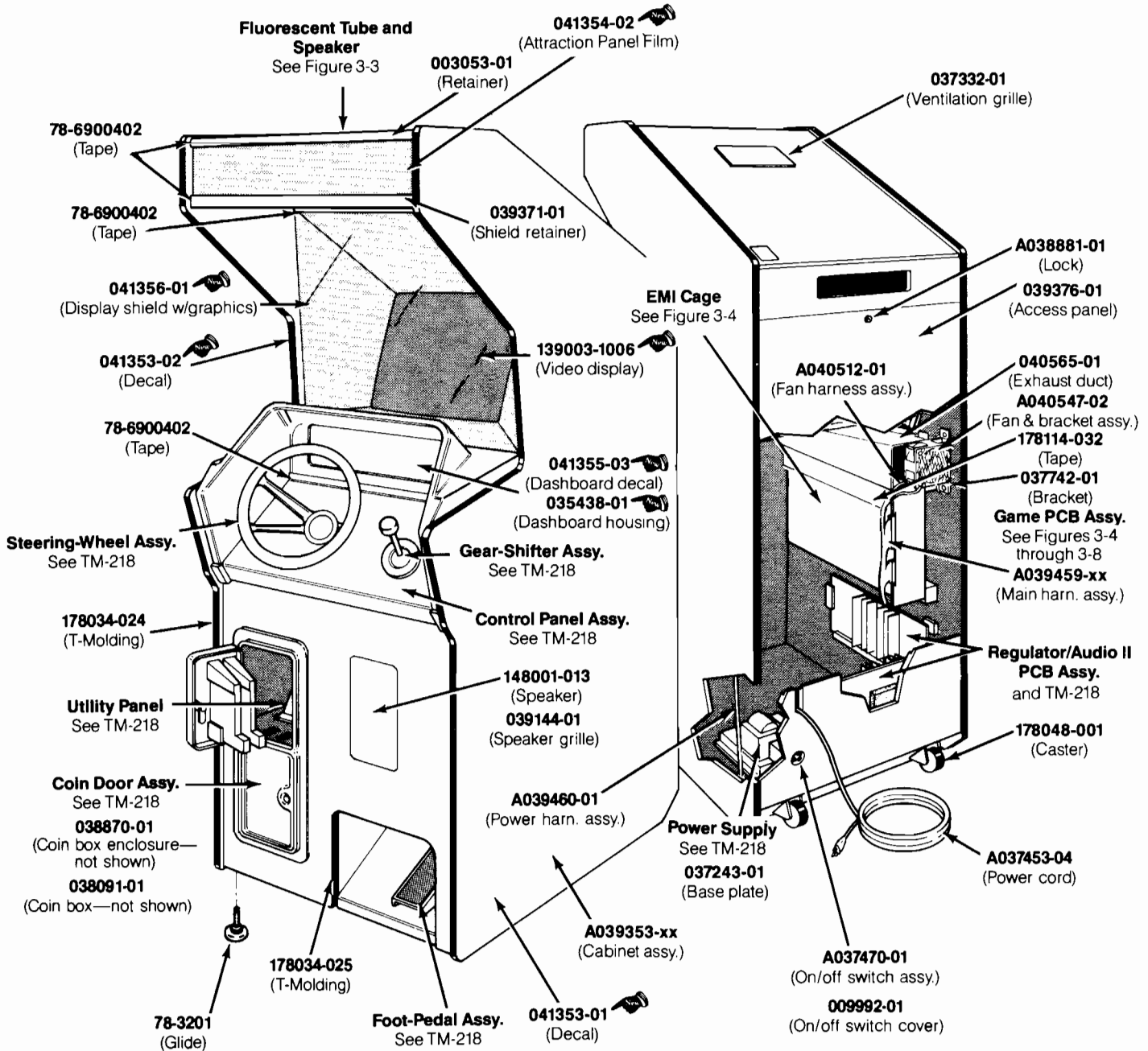

Figure 2-5 Self-Test Screen 2

3 Parts Lists











**Manuals, Schematics, &
Self-Test Label—
See parts list on next page**



**Figure 3-1 Cabinet-Mounted Assemblies
Pole Position II Upright Cabinet A039352-01 T**

Cabinet-Mounted Assemblies Pole Position II Upright Cabinet Parts List

Part No.	Description
A037453-04	Strain-Relief Power Cord <i>(U.S. and Canada)</i>
A037701-01	Electromagnetic Interference Cage <i>(includes glides)</i>
A038600-01	Power On/Off Switch/Mounting Plate Assembly
A038881-01	Lock Assembly <i>(for rear access panel)</i> <i>Acceptable substitute is part no. A038881-03</i>
A039353-01	Cabinet Assembly <i>(includes glides and PCB retainers, but not the rear access panel)</i>
A039420-01	Dashboard Housing and Decal Assembly
A039459-01	Main Harness Assembly
A039460-01	Power Harness Assembly
A039576-01	Coin Option Interconnect Assembly <i>(not shown)</i>
A040512-01	Fan Harness Assembly
A040547-02	Fan and Bracket Assembly <i>Acceptable substitute is part no. A040547-01</i>
003053-01	Attraction Glass Retainer
009992-01	On/Off Switch Cover
035438-01	 Dashboard Housing
037243-01	Base Plate for Power Supply
037332-01	Ventilation Grille
038091-01	Molded Coin Box <i>(not shown)</i>
038641-01	Speaker Grille <i>(not shown)</i>
038770-01	Metal Coin Box Enclosure <i>(Acceptable substitute is part no. 038781-01)</i> <i>(not shown)</i>
039144-01	Speaker Grille
039371-01	Video Display Shield Retainer
039376-01	Rear Access Panel <i>(does not include lock)</i>
040546-01	Printed Circuit Board Mounting Bracket <i>(not shown)</i>
040564-01	Door Panel Grille <i>(not shown)</i>
040565-01	Exhaust Duct
041353-01	 Left Side Panel Decal
041353-02	 Right Side Panel Decal
041354-02	 Attraction Panel Film
041355-03	 Dashboard Decal
041356-01	 Video Display Shield with Graphics
139003-1006	 19-Inch Disco Color Raster-Scan Display
148001-013	6- x 9-Inch Oval, 4-Ohm, 6-Ounce Shielded High-Fidelity Speaker <i>(located on front panel)</i>
178114-032	2-Inch Plastic Tape <i>(20 inches required)</i>
<i>The following nine items are technical information supplements to this game:</i>	
CO-218-12	 Pole Position II Operators Manual
SP-218	Pole Position Schematic Package <i>(for Atari PCBs)</i>
SP-219	Pole Position Schematic Package <i>(for NAMCO PCBs)</i>
ST-255	 Pole Position Chart with Self-Test Procedure and Option Switch Settings

 *New for Pole Position II.*

(Continued on next page)

**Cabinet-Mounted Assemblies
Pole Position II Upright Cabinet
Parts List, continued**

<i>Part No.</i>	<i>Description</i>
TM-160	Service Manual for 19-Inch Electrohome Color Raster-Scan Display (use with part no. 92-049), or
TM-210	Service Manual for 19-Inch Disco Color Raster-Scan Display (use with part no. 139003-1006), or
TM-220	Service Manual for 19-Inch Matsushita Color Raster-Scan Display (use with part no. 139003-1004)
TM-218	Pole Position Operation, Maintenance, and Service Manual
TM-255	Enhancement Instructions
78-3201	Adjustable Glide
78-6900402	Vinyl Foam Single-Coated Adhesive Tape, 1/4-Inch Wide x 1/8-Inch Thick (48 inches required—use on top edge of video display shield, and on top edge of control panel)
78-6900404	Vinyl Foam Single-Coated Adhesive Tape, 1/4-Inch Wide x 1/4-Inch Thick (48 inches required—used on top and bottom of attraction glass)
178034-024	3/4-Inch Black Plastic T-Molding (located on side panels)
178034-025	25/32-Inch Black Plastic T-Molding (located on front panel)
178048-001	2-Inch Rigid Caster

 New for Pole Position II.



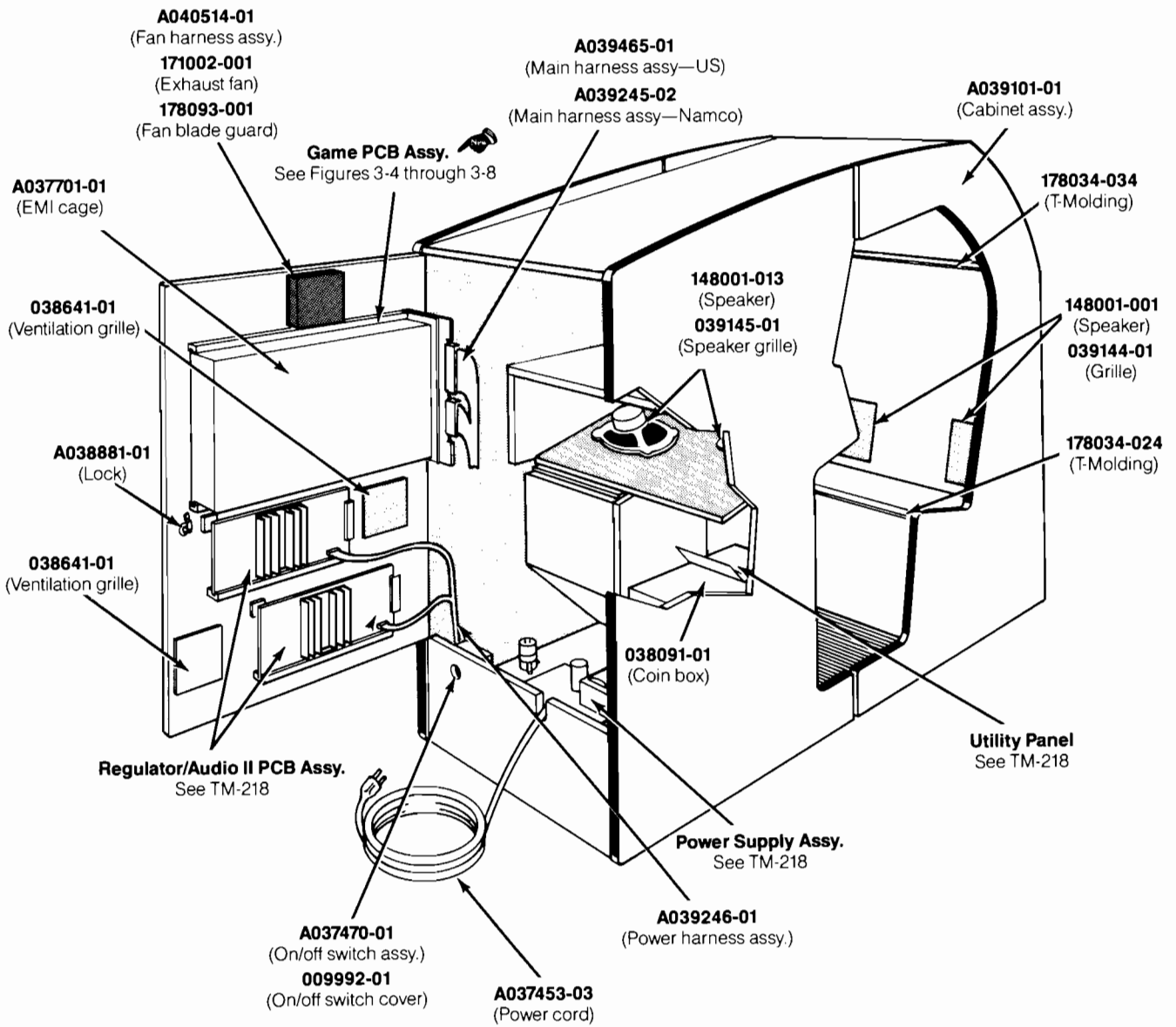

**Figure 3-2 Cabinet-Mounted Assemblies
Pole Position II Sit-Down Cabinet
A039100-01 R**

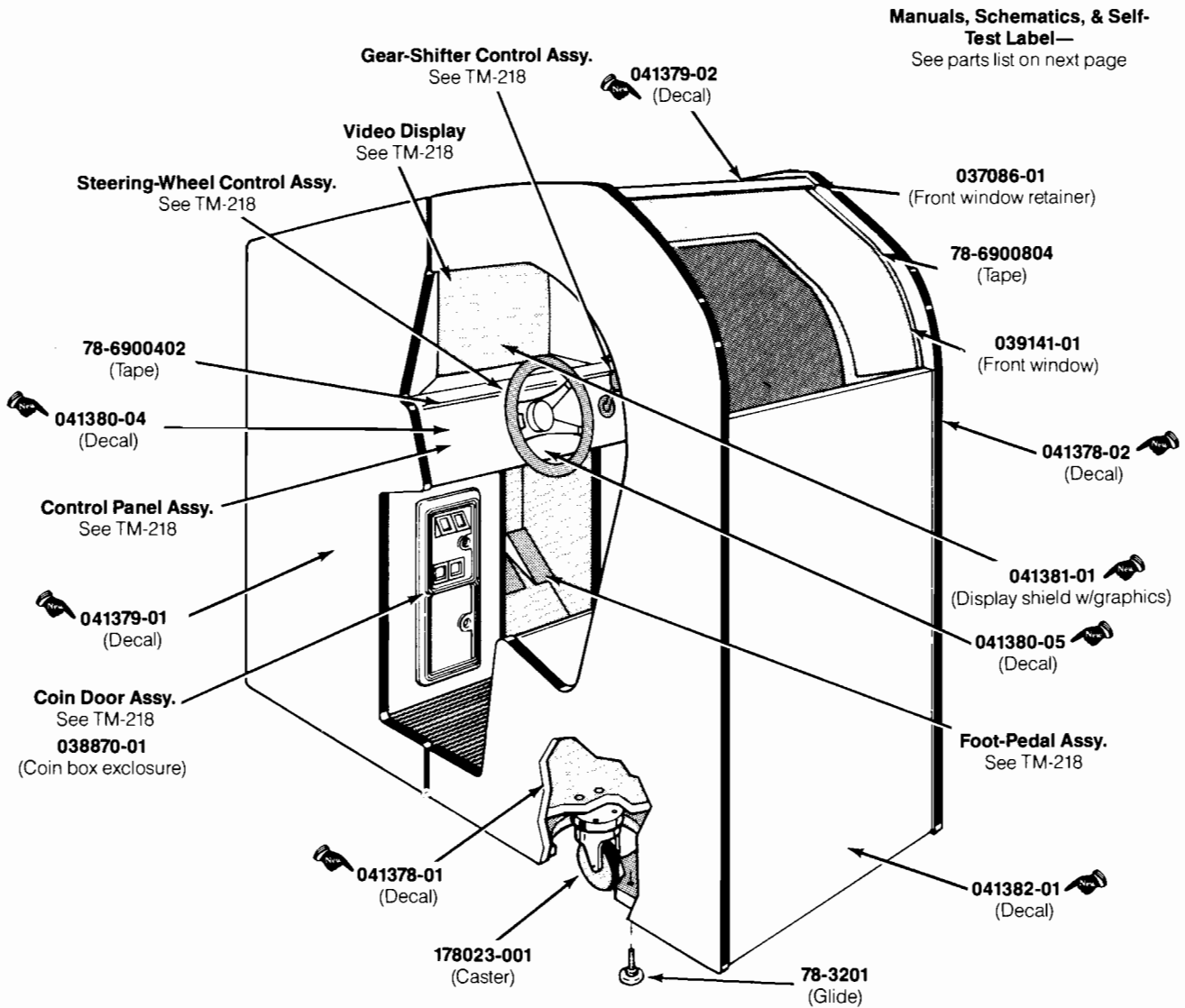





Figure 3-2 Cabinet-Mounted Assemblies, continued
Pole Position II Sit-Down Cabinet
A039100-01 R

Cabinet-Mounted Assemblies Pole Position II Sit-Down Cabinet Parts List

Part No.	Description
A037453-03	Strain-Relief Power Cord (U.S. and Canada)
A037470-01	Power On/Off Switch/Mounting Plate Assembly
A037701-01	Electromagnetic Interference (EMI) Cage (includes guides)
A038881-01	Lock Assembly (for rear access panel) Acceptable substitute is part no. A038881-03
A039101-01	Cabinet Assembly (includes glides and PCB retainers, but not the rear access panel)
A039245-01	Main Harness Assembly (for NAMCO PCBs)
A039246-01	Power Harness Assembly
A039465-01	Main Harness Assembly (for Atari PCBs)
A040514-01	Fan Harness Interconnect Assembly
107001-001	Flat Black Paint (not shown)
171002-001	110 V Exhaust Fan
178093-001	Fan Blade Guard
<i>The following ten items are technical information supplements to this game:</i>	
CO-218-12 	Pole Position II Operators Manual
SP-218	Pole Position Schematic Package (for Atari game PCBs)
SP-219	Pole Position Schematic Package (for NAMCO game PCBs)
ST-255 	Pole Position II Chart with Self-Test Procedure and Option Switch Settings
TM-160	Service Manual for 19-Inch Electrohome Color Raster-Scan Display (use with part no. 92-049)
TM-201	Service Manual for 19-Inch Wells-Gardner Color Raster-Scan Display (use with part no. 92-055)
TM-218	Pole Position Operation, Maintenance, and Service Manual
TM-220	Service Manual for 19-Inch Matsushita Color Raster-Scan Display (use with part no. 139003-1004)
TM-255 	Enhancement Instructions
78-3201	Adjustable Glide
78-6900402	Vinyl Foam Single-Coated Adhesive Tape, 1/4-Inch Wide x 1/8-Inch Thick (72 inches required; used on front window)
78-6900804	Vinyl Foam Single-Coated Adhesive Tape, 1/2-Inch Wide x 1/4-Inch Thick (50 inches required; used in top slot of video display cleat and bottom of display shield)
009992-01	On/Off Switch Cover
035851-01	Top Panel Hinge (not shown)
037086-01	Front Window Retainer
037742-01	Printed-Circuit Board Mounting Bracket (not shown)
038091-01	Molded Coin Box
038641-01	Ventilation Grille (on rear access panel)
038870-01	Metal Coin Box Enclosure Acceptable substitute is part no. 038781-01
039141-01	Front Window

 New to Pole Position II.

(Continued on next page)

**Cabinet-Mounted Assemblies
Pole Position II Sit-Down Cabinet
Parts List, continued**

<i>Part No.</i>	<i>Description</i>
039144-01	Speaker Grille <i>(located behind seat)</i>
039145-01	Speaker Grille <i>(not shown—located under control panel)</i>
041378-01	Left Rear Side Panel Decal
041378-02	Right Rear side Panel Decal
041379-01	Left Front Side Panel Decal
041379-02	Right Front Side Panel Decal
041380-04	Left Control Panel Decal
041380-05	Right Control Panel Decal
041381-01	Video Display Shield with Graphics
041382-01	Front Panel Decal
148001-001	6- x 9-Inch Oval, 4-Ohm, 15 W Unshielded High-Fidelity Speaker <i>(located behind seat)</i>
148001-013	6- x 9-Inch Oval, 4-Ohm, 15 W Shielded High-Fidelity Speaker <i>(located under control panel)</i>
178034-034	1-Inch Black Plastic T-Molding <i>(located on seat back)</i>
178023-001	4-Inch Rigid Caster

 *New to Pole Position II.*

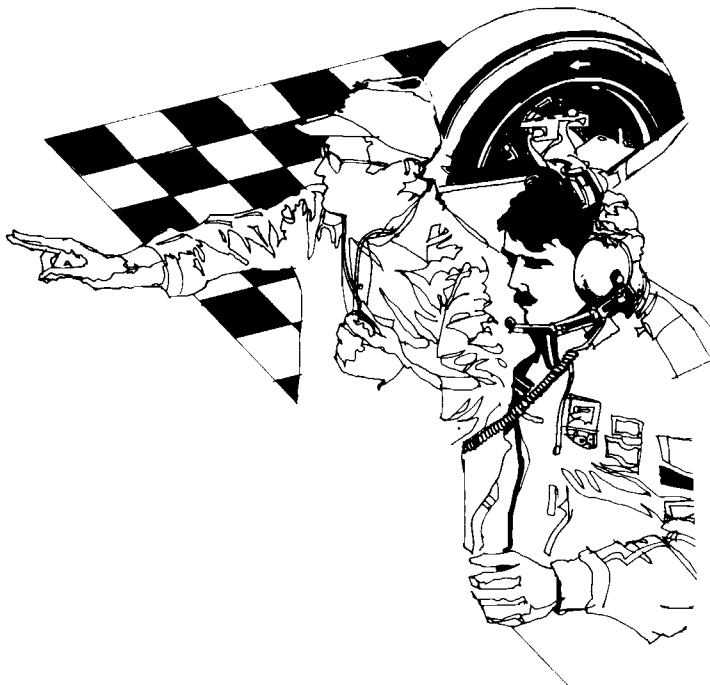

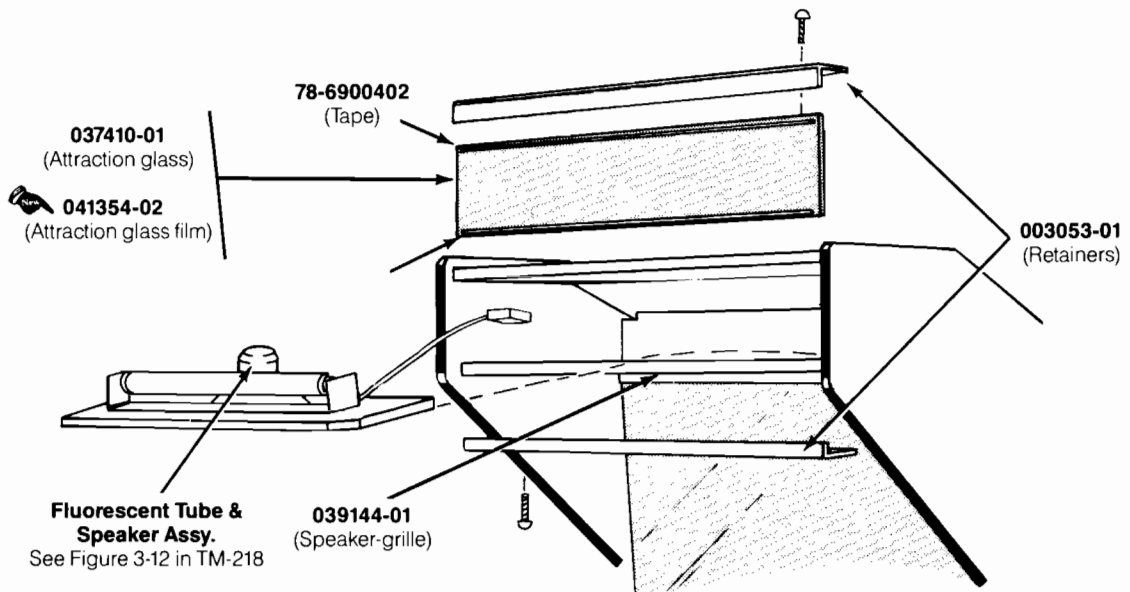

**Figure 3-3 Fluorescent Tube and Speaker Board
Parts List**

<i>Part No.</i>	<i>Description</i>
78-6900402	Vinyl Foam Single-Coated Adhesive Tape, 1/4-Inch Wide x 1/8-Inch Thick
003053-01	Attraction Glass Retainer
037410-01	Attraction Glass
039144-01	Speaker Grille
041354-02 	Attraction Glass Film

 *New to Pole Position II.*

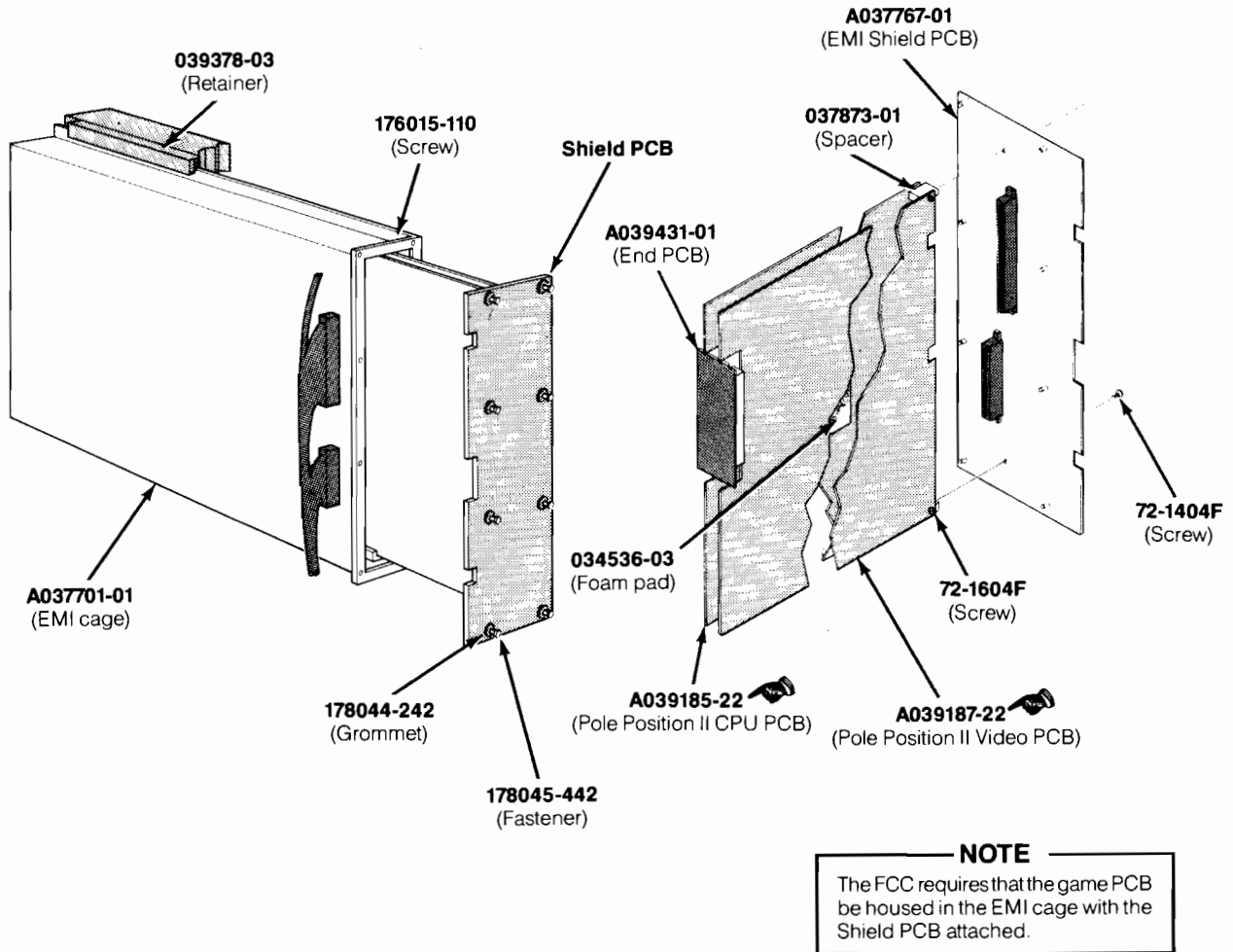

Figure 3-4 Printed-Circuit Board Hardware Parts List

Part No.	Description
A037701-01	Electromagnetic Interference (EMI) Cage <i>(includes guides)</i>
A037767-01	EMI Shield Printed-Circuit Board (PCB)
A039185-22	Pole Position II Central Processing Unit PCB
A039187-22	Pole Position II Video PCB
72-1404F	#4-40 × 1/4-Inch Cross-Recessed Steel Screw
72-1604F	#6-32 × 1/4-Inch Cross-Recessed Steel Screw
034536-03	Foam Pad
037873-01	Spacer
039378-03	Dual-Slotted Retainer
175009-221	Plastic Spacer <i>(for EMI Shield PCB)</i>
176015-110	#10 × 5/8-Inch Cross-Recessed Pan-Head Screw
178044-242	Grommet
178045-442	Snap-In Fastener

New to Pole Position II.

**Atari Pole Position II
Central Processing Unit Printed-Circuit Board Assembly
A039185-22 A
Parts List**

Designator	Description	Part No.
Capacitors		
C2-C5	0.01 μ F, 100 V Radial-Lead Mylar Capacitor	21-101103
C6	33 pF, 100 V Radial-Lead Epoxy-Dipped Mica Capacitor	128002-330
C7	0.1 μ F, $\pm 10\%$, 50 V Ceramic-Disc Axial-Lead Capacitor	122002-104
C9	10 μ F, 25 V Aluminum Electrolytic Fixed Axial-Lead Capacitor <i>Acceptable substitute is part no. 24-350106</i>	24-250106
C10	0.1 μ F, $\pm 10\%$, 50 V Ceramic-Disc Axial-Lead Capacitor	122002-104
C11	47 μ F, 10 V Aluminum Electrolytic Fixed Axial-Lead Capacitor <i>Acceptable substitute is part no. 24-250476 or 24-160476</i>	24- 100476
C12	0.1 μ F, $\pm 10\%$, 50 V Ceramic-Disc Axial-Lead Capacitor	122002-104
C13	0.01 μ F, +80%, -20%, 25 V Ceramic-Disc Axial-Lead Capacitor	122005-103
C14, C15	0.1 μ F, $\pm 10\%$, 50 V Ceramic-Disc Axial-Lead Capacitor	122002-104
C16-C23	0.01 μ F, +80%, -20%, 25 V Ceramic-Disc Axial-Lead Capacitor	122005-103
C24, C25	0.1 μ F, $\pm 10\%$, 50 V Ceramic-Disc Axial-Lead Capacitor	122002-104
C26	47 μ F, 10 V Aluminum Electrolytic Fixed Axial-Lead Capacitor <i>Acceptable substitute is part no. 24-250476 or 24-160476</i>	24- 100476
C27, C28	0.0022 μ F, $\pm 10\%$, 100 V Radial-Lead Plastic Film Capacitor	121022-222
C29, C30	0.022 μ F, 100 V Radial-Lead Mylar Capacitor	21-101223
C31, C32	0.01 μ F, +80%, -20%, 25 V Ceramic-Disc Axial-Lead Capacitor	122005-103
C33, C34	0.047 μ F, 100 V Radial-Lead Mylar Capacitor	21-101473
C35	0.022 μ F, 100 V Radial-Lead Mylar Capacitor	21-101223
C36	0.0047 μ F, 100 V Radial-Lead Mylar Capacitor	21-101472
C37	0.001 μ F, 100 V Radial-Lead Mylar Capacitor	21-101102
C38	0.0047 μ F, 100 V Radial-Lead Mylar Capacitor	21-101472
C39, C40	0.01 μ F, 100 V Radial-Lead Mylar Capacitor	21-101103
C41	47 μ F, 10 V Aluminum Electrolytic Fixed Axial-Lead Capacitor <i>Acceptable substitute is part no. 24-250476 or 24-160476</i>	24- 100476
C42, C43	0.0047 μ F, 100 V Radial-Lead Mylar Capacitor	21-101472
C44, C45	0.001 μ F, 100 V Radial-Lead Mylar Capacitor	21-101102
C46	470 μ F, 16 V Aluminum Electrolytic Fixed Axial-Lead Capacitor <i>Acceptable substitute is part no. 24-100477</i>	24-160477
C47-C56	22 μ F, 16 V Aluminum Electrolytic Fixed Axial-Lead Capacitor <i>Acceptable substitute is part no. 24-250226 or 24-350266</i>	24-160226
C57-C81	0.1 μ F, $\pm 10\%$, 25 V Ceramic-Disc Axial-Lead Capacitor	122002-104
C82	0.001 μ F, 100 V Radial-Lead Mylar Capacitor	21-101102
C83-C88	0.1 μ F, $\pm 10\%$, 25 V Ceramic-Disc Axial-Lead Capacitor	122002-104
C89	100 pF, 100 V Mica Capacitor	128002-101
Diodes		
CR1	Type-MV5053 Light-Emitting Diode	38-MV5053
CR2	Type-1N4735A 6.2 V, $\pm 5\%$, 1 W Zener Diode	131009-001
CR3, CR4	Type-1N914 100 V, Switching Diode	31-1N914
CR5	Type-1N4001, 50 V Rectifier Diode	31-1N4001
CR6	Type-1N748A 3.9 V $\pm 5\%$, Zener Diode	131000-002
CR7-CR12	Type-1N914 100 V, Switching Diode	31-1N914











(Continued on next page)

**Atari Pole Position II
Central Processing Unit Printed-Circuit Board Assembly
Parts List, continued**

<i>Designator</i>	<i>Description</i>	<i>Part No.</i>
Integrated Circuits		
3C	Type-74LS373 Integrated Circuit	37-74LS373
3M/N	Type-74S32 Integrated Circuit	37-74S32
3M, 4C	Type-74LS373 Integrated Circuit	37-74LS373
4M	Type-74LS373 Integrated Circuit	37-74LS373
5A	Type-74LS74 Integrated Circuit	37-74LS74
5D	Type-74LS367 Integrated Circuit	37-74LS367
5E	Type-74LS244 Integrated Circuit	37-74LS244
5J	Type-74LS367 Integrated Circuit	37-74LS367
5K	Type-74LS244 Integrated Circuit	37-74LS244
5L	Type-74LS368 Integrated Circuit	137168-001
5M	Type-74LS158 Integrated Circuit	137203-001
5N	Type-74LS74 Integrated Circuit	37-74LS74
6A	Type-74LS161 Integrated Circuit	37-74LS161
6C	Type-74LS74 Integrated Circuit	37-74LS74
6D-6F	Type-74LS367 Integrated Circuit	37-74LS367
6J, 6K	Type-74LS157 Integrated Circuit	37-74LS157
6L	Type-74LS109 Integrated Circuit	37-74LS109
6M	Type-74LS00 Integrated Circuit	37-74LS00
6N	Type-74S163 Integrated Circuit <i>Acceptable substitute is part no. 137287-001 or 137287-002</i>	137274-001
7K/L	Type-74LS138 Integrated Circuit	137177-001
7L	Type-74LS139 Integrated Circuit	37-74LS139
7N	Type-74S04 Integrated Circuit	37-74S04
8D	Type-74LS138 Integrated Circuit	137177-001
8E	Type-74LS259 Integrated Circuit	37-74LS259
8F	Type-74LS367 Integrated Circuit	37-74LS367
8J	Type-ADC0804 Integrated Circuit	137273-001
8K	Type-4066 Integrated Circuit	37-4066
8L	Type-4584B Integrated Circuit	37-4584B
8M	Type-74S04 Integrated Circuit	37-74S04
9F/B	Type-LM324 Integrated Circuit	37-LM324
10A	Type-74LS138 Integrated Circuit	137177-001
10C	Type-74S374 Integrated Circuit	137206-001
10D	Type-74LS174 Integrated Circuit	37-74LS174
10E, 10F	Type-74LS283 Integrated Circuit	137204-001
10H, 10J	Type-74LS273 Integrated Circuit	37-74LS273
10K, 10L	Type-4066 Integrated Circuit	37-4066
11A	Type-74LS174 Integrated Circuit	37-74LS174
11C	Type-7497 Integrated Circuit	37-7497
11E	Type-74LS273 Integrated Circuit	37-74LS273
11F	Type-4051 Integrated Circuit	137277-001
11H	Type-74LS174 Integrated Circuit	37-74LS174
11J	Type-74LS273 Integrated Circuit	37-74LS273
11K-11M	Type-4066 Integrated Circuit	37-4066
12A	Type-74LS174 Integrated Circuit	37-74LS174

(Continued on next page)

**Atari Pole Position II
Central Processing Unit Printed-Circuit Board Assembly
Parts List, continued**

<i>Designator</i>	<i>Description</i>	<i>Part No.</i>
12B	Type-7497 Integrated Circuit	37-7497
12C	Type-74LS161 Integrated Circuit	37-74LS161
12D	Type-74LS393 Integrated Circuit	37-74LS393
12H	Type-LM324 Integrated Circuit	37-LM324
12J	Type-LM324 Integrated Circuit	37-LM324
12M	Type-LM324 Integrated Circuit	37-LM324
for -22 version only		
2N	Type-12L6 Programmable-Array Logic 1	137316-001
3A	Type-Z8002 16-Bit Microprocessor	137275-001
3F, 3H	Custom Integrated Circuit 10	137281-001
4F, 4H	Custom Integrated Circuit 10	137281-001
4K	 Custom Integrated Circuit 25	137351-001
4N	Type-Z8002 16-Bit Microprocessor	137275-001
5C	Type-12L6 Programmable-Array Logic 1	137316-001
6H	Custom Integrated Circuit 08	137186-001
7C	Type-10L8 Programmable-Array Logic 3	137279-001
7D	Type-Z80A 8-Bit Microprocessor	137194-001
7M	Custom Integrated Circuit 07	137193-001
8H	Custom Integrated Circuit 08	137186-001
9E	Custom Integrated Circuit 52	137284-001
9FA	Custom Integrated Circuit 54	137285-001
9H	Custom Integrated Circuit 06	137192-001
9K	Custom Integrated Circuit 53	137188-001
9M	Custom Integrated Circuit 51	137187-001
Random-Access Memories		
7J	Random-Access Memory	137199-001
7K	Random-Access Memory	137199-001
Read-Only Memory		
11D	Programmable Read-Only Memory	136014-118
for -22 version only		
7E	CMOS Random-Access Memory	137278-001
9C	Electrically Programmable Read-Only Memory <i>Acceptable substitute is part no. 136014-147</i>	136014-106
3D	 Electrically Programmable Read-Only Memory	136014-184
3E	 Electrically Programmable Read-Only Memory	136014-178
3L	 Electrically Programmable Read-Only Memory	136014-176
4D	 Electrically Programmable Read-Only Memory	136014-185
4E	 Electrically Programmable Read-Only Memory	136014-179
4L	 Electrically Programmable Read-Only Memory	136014-177
7F	 Electrically Programmable Read-Only Memory	136014-183
7H	 Electrically Programmable Read-Only Memory	136014-180
12E	 Electrically Programmable Read-Only Memory	136014-182
12F	 Electrically Programmable Read-Only Memory	136014-181

 *New to Pole Position II.*

(Continued on next page)

**Atari Pole Position II
Central Processing Unit Printed-Circuit Board Assembly
Parts List, continued**

<i>Designator</i>	<i>Description</i>	<i>Part No.</i>
Resistors		
R1	220 Ω , $\pm 5\%$, 1/4 W Resistor	110000-221
R2-R8	2.2 k Ω , $\pm 5\%$, 1/4 W Resistor	110000-222
R9	1 k Ω , $\pm 5\%$, 1/4 W Resistor	110000-102
R10-R16	2.2 k Ω , $\pm 5\%$, 1/4 W Resistor	110000-222
R17-R26	1 k Ω , $\pm 5\%$, 1/4 W Resistor	110000-102
R27-R34	2.2 k Ω , $\pm 5\%$, 1/4 W Resistor	110000-222
R35	1 k Ω , $\pm 5\%$, 1/4 W Resistor	110000-102
R36-R38	2.2 k Ω , $\pm 5\%$, 1/4 W Resistor	110000-222
R39-R43	1 k Ω , $\pm 5\%$, 1/4 W Resistor	110000-102
R45	47 Ω , $\pm 5\%$, 1/4 W Resistor	110000-470
R46, R47	1 k Ω , $\pm 5\%$, 1/4 W Resistor	110000-102
R52	470 Ω , $\pm 5\%$, 1/4 W Resistor	110000-471
R53	1 k Ω , $\pm 5\%$, 1/4 W Resistor	110000-102
R54	470 Ω , $\pm 5\%$, 1/4 W Resistor	110000-471
R55, R56	1 k Ω , $\pm 5\%$, 1/4 W Resistor	110000-102
R57-R60	470 Ω , $\pm 5\%$, 1/4 W Resistor	110000-471
R61	4.7 k Ω , $\pm 5\%$, 1/4 W Resistor	110000-472
R62	10 k Ω , $\pm 5\%$, 1/4 W Resistor	110000-103
R63	22 k Ω , $\pm 5\%$, 1/4 W Resistor	110000-223
R64	47 k Ω , $\pm 5\%$, 1/4 W Resistor	110000-473
R65	4.7 k Ω , $\pm 5\%$, 1/4 W Resistor	110000-472
R66	10 k Ω , $\pm 5\%$, 1/4 W Resistor	110000-103
R67	22 k Ω , $\pm 5\%$, 1/4 W Resistor	110000-223
R68	47 k Ω , $\pm 5\%$, 1/4 W Resistor	110000-473
R69	4.7 k Ω , $\pm 5\%$, 1/4 W Resistor	110000-472
R70	10 k Ω , $\pm 5\%$, 1/4 W Resistor	110000-103
R71	22 k Ω , $\pm 5\%$, 1/4 W Resistor	110000-223
R72	47 k Ω , $\pm 5\%$, 1/4 W Resistor	110000-473
R73	4.7 k Ω , $\pm 5\%$, 1/4 W Resistor	110000-472
R74	10 k Ω , $\pm 5\%$, 1/4 W Resistor	110000-103
R75	22 k Ω , $\pm 5\%$, 1/4 W Resistor	110000-223
R76	47 k Ω , $\pm 5\%$, 1/4 W Resistor	110000-473
R77-R80	1 k Ω , $\pm 5\%$, 1/4 W Resistor	110000-102
R81	220 Ω , $\pm 5\%$, 1/4 W Resistor	110000-221
R82	1 k Ω , $\pm 5\%$, 1/4 W Resistor	110000-102
R83	470 Ω , $\pm 5\%$, 1/4 W Resistor	110000-471
R84	1 k Ω , $\pm 5\%$, 1/4 W Resistor	110000-102
R85	2.2 k Ω , $\pm 5\%$, 1/4 W Resistor	110000-222
R86	330 Ω , $\pm 5\%$, 1/4 W Resistor	110000-331
R87	1 k Ω , $\pm 5\%$, 1/4 W Resistor	110000-102
R88	22 k Ω , $\pm 5\%$, 1/4 W Resistor	110000-223
R89	100 Ω , $\pm 5\%$, 1/4 W Resistor	110000-101
R90-R92	1 k Ω , $\pm 5\%$, 1/4 W Resistor	110000-102
R93, R94	330 Ω , $\pm 5\%$, 1/4 W Resistor	110000-331
R95	1 k Ω , $\pm 5\%$, 1/4 W Resistor	110000-102
R96	4.7 k Ω , $\pm 5\%$, 1/4 W Resistor	110000-472
R97	220 Ω , $\pm 5\%$, 1/4 W Resistor	110000-221

(Continued on next page)

**Atari Pole Position II
Central Processing Unit Printed-Circuit Board Assembly
Parts List, continued**

<i>Designator</i>	<i>Description</i>	<i>Part No.</i>
R98	4.7 k Ω , $\pm 5\%$, 1/4 W Resistor	110000-472
R99	220 Ω , $\pm 5\%$, 1/4 W Resistor	110000-221
R101	2.2 k Ω , $\pm 5\%$, 1/4 W Resistor	110000-222
R102, R104	1 k Ω , $\pm 5\%$, 1/4 W Resistor	110000-102
R103	4.7 k Ω , $\pm 5\%$, 1/4 W Resistor	110000-472
R106	1 k Ω , $\pm 5\%$, 1/4 W Resistor	110000-102
R107	4.7 k Ω , $\pm 5\%$, 1/4 W Resistor	110000-472
R108-115	1 k Ω , $\pm 5\%$, 1/4 W Resistor	110000-102
R116	1.5 k Ω , $\pm 5\%$, 1/4 W Resistor	110000-152
R117	1 k Ω , $\pm 5\%$, 1/4 W Resistor	110000-102
R118	4.7 k Ω , $\pm 5\%$, 1/4 W Resistor	110000-472
R119	10 k Ω , $\pm 5\%$, 1/4 W Resistor	110000-103
R120, R121	22 k Ω , $\pm 5\%$, 1/4 W Resistor	110000-223
R122	120 k Ω , $\pm 5\%$, 1/4 W Resistor	110000-124
R123	470 Ω , $\pm 5\%$, 1/4 W Resistor	110000-471
R124	47 k Ω , $\pm 5\%$, 1/4 W Resistor	110000-473
R125	12 k Ω , $\pm 5\%$, 1/4 W Resistor	110000-123
R126	4.7 k Ω , $\pm 5\%$, 1/4 W Resistor	110000-472
R127, R128	2.2 k Ω , $\pm 5\%$, 1/4 W Resistor	110000-222
R129, R130	3.3 k Ω , $\pm 5\%$, 1/4 W Resistor	110000-332
R131	10 k Ω , $\pm 5\%$, 1/4 W Resistor	110000-103
R132	22 k Ω , $\pm 5\%$, 1/4 W Resistor	110000-223
R133	15 k Ω , $\pm 5\%$, 1/4 W Resistor	110000-153
R134	120 k Ω , $\pm 5\%$, 1/4 W Resistor	110000-124
R135	470 Ω , $\pm 5\%$, 1/4 W Resistor	110000-471
R136	47 k Ω , $\pm 5\%$, 1/4 W Resistor	110000-473
R137	15 k Ω , $\pm 5\%$, 1/4 W Resistor	110000-153
R138	10 k Ω , $\pm 5\%$, 1/4 W Resistor	110000-103
R139	22 k Ω , $\pm 5\%$, 1/4 W Resistor	110000-223
R140	180 k Ω , $\pm 5\%$, 1/4 W Resistor	110000-184
R141	470 Ω , $\pm 5\%$, 1/4 W Resistor	110000-471
R142, R143	22 k Ω , $\pm 5\%$, 1/4 W Resistor	110000-223
R144-R151	1 k Ω , $\pm 5\%$, 1/4 W Resistor	110000-102
R152	47 k Ω , $\pm 5\%$, 1/4 W Resistor	110000-473
R153	470 Ω , $\pm 5\%$, 1/4 W Resistor	110000-471
R154	10 k Ω , $\pm 5\%$, 1/4 W Resistor	110000-103
R155	82 k Ω , $\pm 5\%$, 1/4 W Resistor	110000-823
R156, R157	47 k Ω , $\pm 5\%$, 1/4 W Resistor	110000-473
R158	22 k Ω , $\pm 5\%$, 1/4 W Resistor	110000-223
R159	47 k Ω , $\pm 5\%$, 1/4 W Resistor	110000-473
R160	100 k Ω , $\pm 5\%$, 1/4 W Resistor	110000-104
R161-R165	2.2 k Ω , $\pm 5\%$, 1/4 W Resistor	110000-222
R166	1 k Ω , $\pm 5\%$, 1/4 W Resistor	110000-102
R167	2.2 k Ω , $\pm 5\%$, 1/4 W Resistor	110000-222
R168	4.7 k Ω , $\pm 5\%$, 1/4 W Resistor	110000-472
R169	220 k Ω , $\pm 5\%$, 1/4 W Resistor	110000-224
R170	390 k Ω , $\pm 5\%$, 1/4 W Resistor	110000-394

(Continued on next page)

**Atari Pole Position II
Central Processing Unit Printed-Circuit Board Assembly
Parts List, continued**

<i>Designator</i>	<i>Description</i>	<i>Part No.</i>
R171	4.7 k Ω , \pm 5%, 1/4 W Resistor	110000-472
R172	15 k Ω , \pm 5%, 1/4 W Resistor	110000-153
R173	47 k Ω , \pm 5%, 1/4 W Resistor	110000-473
R174	33 k Ω , \pm 5%, 1/4 W Resistor	110000-333
R175	10 k Ω , \pm 5%, 1/4 W Resistor	110000-103
R176	47 k Ω , \pm 5%, 1/4 W Resistor	110000-473
R177	1 k Ω , \pm 5%, 1/4 W Resistor	110000-102
R178	75 k Ω , \pm 5%, 1/4 W Resistor	110000-752
R179	330 k Ω , \pm 5%, 1/4 W Resistor	110000-334
R180, R181	47 k Ω , \pm 5%, 1/4 W Resistor	110000-473
R182	1 k Ω , \pm 5%, 1/4 W Resistor	110000-102
R183	22 k Ω , \pm 5%, 1/4 W Resistor	110000-223
R184	15 k Ω , \pm 5%, 1/4 W Resistor	110000-153
R185	10 k Ω , \pm 5%, 1/4 W Resistor	110000-103
R186	1 k Ω , \pm 5%, 1/4 W Resistor	110000-102
R187	330 k Ω , \pm 5%, 1/4 W Resistor	110000-334
R188	10 k Ω , \pm 5%, 1/4 W Resistor	110000-103
R189, R190	47 k Ω , \pm 5%, 1/4 W Resistor	110000-473
R191	1 k Ω , \pm 5%, 1/4 W Resistor	110000-102
R192	75 k Ω , \pm 5%, 1/4 W Resistor	110000-753
R193	15 k Ω , \pm 5%, 1/4 W Resistor	110000-153
R194	47 k Ω , \pm 5%, 1/4 W Resistor	110000-473
R195	10 k Ω , \pm 5%, 1/4 W Resistor	110000-103
R196	1 k Ω , \pm 5%, 1/4 W Resistor	110000-102
R197, R198	47 k Ω , \pm 5%, 1/4 W Resistor	110000-473
R199	1 k Ω , \pm 5%, 1/4 W Resistor	110000-102
R200	47 k Ω , \pm 5%, 1/4 W Resistor	110000-473
R201	15 k Ω , \pm 5%, 1/4 W Resistor	110000-153
R202	10 k Ω , \pm 5%, 1/4 W Resistor	110000-103
R203	1 k Ω , \pm 5%, 1/4 W Resistor	110000-102
R204, R205	47 k Ω , \pm 5%, 1/4 W Resistor	110000-473
R206	1 k Ω , \pm 5%, 1/4 W Resistor	110000-102
R207	20 k Ω , \pm 5%, 1/4 W Resistor	110000-203
R208	10 k Ω , \pm 5%, 1/4 W Resistor	110000-103
R209	20 k Ω , \pm 5%, 1/4 W Resistor	110000-203
R210	10 k Ω , \pm 5%, 1/4 W Resistor	110000-103
R211	20 k Ω , \pm 5%, 1/4 W Resistor	110000-203
R212	10 k Ω , \pm 5%, 1/4 W Resistor	110000-103
R213	20 k Ω , \pm 5%, 1/4 W Resistor	110000-203
R214	10 k Ω , \pm 5%, 1/4 W Resistor	110000-103
R215	20 k Ω , \pm 5%, 1/4 W Resistor	110000-203
R216	10 k Ω , \pm 5%, 1/4 W Resistor	110000-103
R217	20 k Ω , \pm 5%, 1/4 W Resistor	110000-203
R218	10 k Ω , \pm 5%, 1/4 W Resistor	110000-103

(Continued on next page)

Atari Pole Position II Central Processing Unit Printed-Circuit Board Assembly Parts List, continued

Designator	Description	Part No.
R219	20 k Ω , \pm 5%, 1/4 W Resistor	110000-203
R220	27 k Ω , \pm 5%, 1/4 W Resistor	110000-273
R223	1 k Ω , \pm 5%, 1/4 W Resistor	110000-102
R225–R231	1 k Ω , \pm 5%, 1/4 W Resistor	110000-102
R231–R238	2.2 k Ω , \pm 5%, 1/4 W Resistor	110000-222
R239–R244	1 k Ω , \pm 5%, 1/4 W Resistor	110000-102
R245	100 Ω , \pm 5%, 1/4 W Resistor	110000-101
R246	150 k Ω , \pm 5%, 1/4 W Resistor	110000-154
R249	150 Ω , \pm 5%, 1/4 W Resistor	110000-151
1E	2.2 k Ω , \pm 2%, Dual-Inline-Package Resistor Network	118003-222
9N	1 k Ω , \pm 2%, Dual-Inline-Package Resistor Network	118003-102
Sockets		
3A	40-Contact Medium-Insertion-Force Integrated Circuit Socket	79-42C40
3D	28-Contact Medium-Insertion-Force Integrated Circuit Socket	79-42C28
3E, 3F	28-Contact Medium-Insertion-Force Integrated Circuit Socket	79-42C28
3H	28-Contact Medium-Insertion-Force Integrated Circuit Socket	79-42C28
3L	28-Contact Medium-Insertion-Force Integrated Circuit Socket	79-42C28
4D	28-Contact Medium-Insertion-Force Integrated Circuit Socket	79-42C28
4E, 4F	28-Contact Medium-Insertion-Force Integrated Circuit Socket	79-42C28
4H	28-Contact Medium-Insertion-Force Integrated Circuit Socket	79-42C28
4K	28-Contact Medium-Insertion-Force Integrated Circuit Socket	79-42C28
4L	28-Contact Medium-Insertion-Force Integrated Circuit Socket	79-42C28
4N	40-Contact Medium-Insertion-Force Integrated Circuit Socket	79-42C40
6H–9H	28-Contact Medium-Insertion-Force Integrated Circuit Socket	79-42C28
7D	40-Contact Medium-Insertion-Force Integrated Circuit Socket	79-42C40
7E, 7F	24-Contact Medium-Insertion-Force Integrated Circuit Socket	79-42C24
9E	42-Contact Medium-Insertion-Force Integrated Circuit Socket	79-42C42
9F/A	28-Contact Medium-Insertion-Force Integrated Circuit Socket	79-42C28
9K	42-Contact Medium-Insertion-Force Integrated Circuit Socket	79-42C42
9M	42-Contact Medium-Insertion-Force Integrated Circuit Socket	79-42C42
12E, 12F	28-Contact Medium-Insertion-Force Integrated Circuit Socket	79-42C28
Switches		
9JA	8-Station, Single-Throw, Dual-Inline-Package Bit Switch	66-118PIT
9L	8-Station, Single-Throw, Dual-Inline-Package Bit Switch	66-118PIT
Transistors		
Q1	Type-2N3906 40 V, 1 W, PNP Transistor	33-2N3906
Q2	Type-2N3904 60 V, 350 mW, NPN Transistor	34-2N3904
Q3	Type-MPS-A92 300 V, 500 mA, PNP Transistor	33-MPSA92
Q4	Type-2N3904 60 V, 350 mW, NPN Transistor	34-2N3904
Q5, Q6	Type-2N6044 80 V, 8 A, Darlington NPN Transistor	34-2N6044
Miscellaneous		
	Test Point <i>Acceptable substitute is part no. 020670-01</i>	179051-001
	Jumper Staple	150009-001
BT1	3.6 V, 100 mA Nickel-Cadmium Battery	171028-001
W1	Lead-Spring Socket Terminal	179131-001
Q5, Q6	Nylon Snap-In Fastener	81-4302

 New to Pole Position II.

Pole Position II
Namco Central Processing Unit Printed-Circuit Board Assembly
171031-001 A
Parts List

<i>Designator</i>	<i>Description</i>	<i>Part No.</i>
Capacitors		
C1	470 μ F, 16 V Aluminum Electrolytic Fixed Axial-Lead Capacitor	24-160477
C2–C4	0.1 μ F, \pm 10%, 25 V Ceramic-Disc Axial-Lead Capacitor	122005-104
C5	47 μ F, 10 V Aluminum Electrolytic Fixed Axial-Lead Capacitor	24-100476
C6, C7	0.001 μ F, 100 V Radial-Lead Mylar Capacitor	21-101102
C8	0.1 μ F, \pm 10%, 25 V Ceramic-Disc Axial-Lead Capacitor	122005-104
C9	0.001 μ F, 100 V Radial-Lead Mylar Capacitor	21-101102
C9	0.01 μ F, +80%, -20%, 25 V Ceramic-Disc Axial-Lead Capacitor	122005-103
C10	0.01 μ F, +80%, -20%, 25 V Ceramic-Disc Axial-Lead Capacitor	122005-103
C11, C12	0.0047 μ F, 100 V Radial-Lead Mylar Capacitor	21-101472
C13–C15	0.1 μ F, \pm 10%, 25 V Ceramic-Disc Axial-Lead Capacitor	122005-104
C16, C17	4.7 μ F, \pm 20%, 16 V Radial-Lead Tantalum Capacitor	121014-475
C18	47 μ F, 10 V Aluminum Electrolytic Fixed Axial-Lead Capacitor	24-100476
C19	0.01 μ F, +80%, -20%, 25 V Ceramic-Disc Axial-Lead Capacitor	122005-103
C20	0.01 μ F, +80%, -20%, 25 V Ceramic-Disc Axial-Lead Capacitor	122005-103
C21	0.1 μ F, \pm 10%, 25 V Ceramic-Disc Axial-Lead Capacitor	122005-104
C22	4.7 μ F, 16 V Radial-Lead Mylar Capacitor	121014-475
C23	0.1 μ F, \pm 10%, 25 V Ceramic-Disc Axial-Lead Capacitor	122005-104
C24, C25	0.01 μ F, +80%, -20%, 25 V Ceramic-Disc Axial-Lead Capacitor	122005-103
C26	0.0022 μ F, \pm 10%, 100 V Radial-Lead Mylar Capacitor	121022-222
C28	0.0047 μ F, 100 V Radial-Lead Mylar Capacitor	21-101472
C29	0.001 μ F, 100 V Radial-Lead Mylar Capacitor	21-101102
C30, C31	0.0022 μ F, \pm 10%, 100 V Radial-Lead Plastic Capacitor	121022-222
C32	0.1 μ F, \pm 10%, 25 V Ceramic-Disc Axial-Lead Capacitor	122005-104
C33, C34	0.047 μ F, 100 V Radial-Lead Mylar Capacitor	21-101473
C35, C36	0.0022 μ F, \pm 10%, 100 V Radial-Lead Mylar Capacitor	121022-222
C37	0.1 μ F, \pm 10%, 25 V Ceramic-Disc Axial-Lead Capacitor	122005-104
C38–C47	0.01 μ F, +80%, -20%, 25 V Ceramic-Disc Axial-Lead Capacitor	122005-103
C48–C50	0.1 μ F, \pm 10%, 25 V Ceramic-Disc Axial-Lead Capacitor	122005-104
C51	0.01 μ F, +80%, -20%, 25 V Ceramic-Disc Axial-Lead Capacitor	122005-103
C52	0.1 μ F, \pm 10%, 25 V Ceramic-Disc Axial-Lead Capacitor	122005-104
C53	47 μ F, 10 V Aluminum Electrolytic Fixed Axial-Lead Capacitor	24-100476
C54, C55	0.1 μ F, \pm 10%, 25 V Ceramic-Disc Axial-Lead Capacitor	122005-104
C56	22 μ F, 16 V Aluminum Electrolytic Fixed Axial-Lead Capacitor	24-160226
C57–C61	0.1 μ F, \pm 10%, 25 V Ceramic-Disc Axial-Lead Capacitor	122005-104
C62, C63	4.7 μ F, 16 V Radial-Lead Mylar Capacitor	121014-475
C64, C65	0.1 μ F, \pm 10%, 25 V Ceramic-Disc Axial-Lead Capacitor	122005-104
C67, C68	0.1 μ F, \pm 10%, 25 V Ceramic-Disc Axial-Lead Capacitor	122005-104
C69	4.7 μ F, 16 V Radial-Lead Mylar Capacitor	121014-475
C70	33 pF, 100 V Radial-Lead Epoxy-Dipped Mica Capacitor	128002-330
C71–C73	0.1 μ F, \pm 10%, 25 V Ceramic-Disc Axial-Lead Capacitor	122005-104



(Continued on next page)

Pole Position II
Namco Central Processing Unit Printed-Circuit Board Assembly
Parts List, continued

<i>Designator</i>	<i>Description</i>	<i>Part No.</i>
C74	4.7 μ F, 16 V Radial-Lead Mylar Capacitor	121014-475
C75	0.1 μ F, $\pm 10\%$, 25 V Ceramic-Disc Axial-Lead Capacitor	122005-104
C76	4.7 μ F, 16 V Radial-Lead Mylar Capacitor	121014-475
C77	0.1 μ F, $\pm 10\%$, 25 V Ceramic-Disc Axial-Lead Capacitor	122005-104
C78	4.7 μ F, 16 V Radial-Lead Mylar Capacitor	121014-475
C79-C81	0.1 μ F, $\pm 10\%$, 25 V Ceramic-Disc Axial-Lead Capacitor	122005-104
C83	0.1 μ F, $\pm 10\%$, 25 V Ceramic-Disc Axial-Lead Capacitor	122005-104
C84	33 pF, 100 V Radial-Lead Epoxy-Dipped Mica Capacitor	128002-330
C85-87	0.1 μ F, $\pm 10\%$, 25 V Ceramic-Disc Axial-Lead Capacitor	122005-104
C88, C89	1000 μ F, 100 V Epoxy-Dipped Mica Capacitor	128002-002
C90	0.1 μ F, $\pm 10\%$, 25 V Ceramic-Disc Axial-Lead Capacitor	122005-104
Diodes		
D1	6.2 V, 1 W Type-1N4735A Zener Diode	131009-001
D2-D9	75 V, Type-1N914 Switching Diode	31-1N914
D10	3.3 V $\pm 5\%$ Zener Diode	131014-001
Integrated Circuits		
1A, 1B	Type-74LS174 Integrated Circuit	37-74LS174
1C	Type-74LS138 Integrated Circuit	137177-001
1J	Type-74LS161 Integrated Circuit	37-74LS161
1K	Type-74LS74 Integrated Circuit	37-74LS74
1L	Type-Z8002 16-Bit Microprocessor	137275-001
2A, 2B	Type-7497 Integrated Circuit	37-7497
2C	Type-74LS374 Integrated Circuit	37-74LS374
2H	Type-10L8 Programmable-Array Logic 3	137279-001
2J	Type-74LS74 Integrated Circuit	37-74LS74
2K	Type-12L6 Programmable-Array Logic 1	137280-001
2L, 2M	Type-74LS373 Integrated Circuit	37-74LS373
3A	Type-74LS138 Integrated Circuit	137177-001
3A	Type-74LS161 Integrated Circuit	37-74LS161
3C	Type-74LS174 Integrated Circuit	37-74LS174
3D	Custom Integrated Circuit 52	137284-001
3H	Type-Z80A 8-Bit Microprocessor	137194-001
3J, 3K	Type-74LS367 Integrated Circuit	37-74LS367
4A	Type-74LS393 Integrated Circuit	37-74LS393
4B	Type-74LS273 Integrated Circuit	37-74LS273
4C	Type-74LS283 Integrated Circuit	137204-001
4E	Custom Integrated Circuit 54	137285-001
4F	Type-74LS259 Integrated Circuit	37-74LS259
4J	Type-74LS367 Integrated Circuit	37-74LS367
4K	Type-74LS244 Integrated Circuit	37-74LS244
5B	Type-4051 Integrated Circuit	137277-001
5C	Type-74LS283 Integrated Circuit	137204-001
5D	Type-LM324 Integrated Circuit	37-LM324
5F	Type-74LS367 Integrated Circuit	37-74LS367

(Continued on next page)









Pole Position II
Namco Central Processing Unit Printed-Circuit Board Assembly
Parts List, continued

<i>Designator</i>	<i>Description</i>	<i>Part No.</i>
5J	Type-74LS367 Integrated Circuit	37-74LS367
5L, 5M	Custom Integrated Circuit 10	137281-001
6B	Type-74LS174 Integrated Circuit	37-74LS174
6C	Type-74LS273 Integrated Circuit	37-74LS273
6E	Custom Integrated Circuit 06	137192-001
6F	Custom Integrated Circuit 08	137186-001
6J	Custom Integrated Circuit 08	137186-001
6L, 6M	Custom Integrated Circuit 10	137281-001
7B, 7C	Type-74LS273 Integrated Circuit	37-74LS273
7J	Type-74LS157 Integrated Circuit	37-74LS157
7L	 Custom Integrated Circuit 25	137351-001
8A	Type-LM324 Integrated Circuit	37-LM324
8B, 8C	Type-4066 Integrated Circuit	37-4066
8D	Custom Integrated Circuit 53	137188-001
8F	Type-4066 Integrated Circuit	37-4066
8J	Type-74LS157 Integrated Circuit	37-74LS157
8K	Type-74LS244 Integrated Circuit	37-74LS244
9B, 9C	Type-4066 Integrated Circuit	37-4066
9J	Type-74LS109 Integrated Circuit	37-74LS109
9K	Type-74LS368 Integrated Circuit	137168-001
9L, 9M	Type-74LS373 Integrated Circuit	37-74LS373
10A	Type-LM324 Integrated Circuit	37-LM324
10B	Type-4066 Integrated Circuit	37-4066
10D	Custom Integrated Circuit 51	137187-001
10H	Custom Integrated Circuit 07	137193-001
10J	Type-74LS00 Integrated Circuit	37-74LS00
10L	Type-Z8002 16-Bit Microprocessor	137275-001
11H	Type-74S04 Integrated Circuit	37-74S04
11J	Type-74S161 Integrated Circuit	137274-001
11L	Type-74LS74 Integrated Circuit	37-74LS74
11M	Type-12L6 Programmable-Array Logic 1	137280-001
Random-Access Memories		
4H	Static-2048x8 (200 ns) CMOS Random-Access Memory	137278-001
7H	Static-1024x4 (55 ns) Random-Access Memory	137199-001
8H	Static-1024x4 (55 ns) Random-Access Memory	137199-001
Read-Only Memories		
2E	Electrically Programmable Read-Only Memory 11	136014-106
3B	Programmable Read-Only Memory 5	136014-118
3L	 Electrically Programmable Read-Only Memory	136014-185
3M	 Electrically Programmable Read-Only Memory	136014-184

 *New to Pole Position II.*

(Continued on next page)

Pole Position II
Namco Central Processing Unit Printed-Circuit Board Assembly
Parts List, continued

<i>Designator</i>	<i>Description</i>	<i>Part No.</i>
4L	 Electrically Programmable Read-Only Memory 6	136014-179
4M	 Electrically Programmable Read-Only Memory 5	136014-178
5A	 Electrically Programmable Read-Only Memory 16	136014-182
5H	 Electrically Programmable Read-Only Memory 10	136014-183
6A	 Electrically Programmable Read-Only Memory 15	136014-181
6H	 Electrically Programmable Read-Only Memory 9	136014-180
8L	 Electrically Programmable Read-Only Memory 2	136014-177
8M	 Electrically Programmable Read-Only Memory 1	136014-176
9H	 Programmable Read-Only Memory 4	136014-117
Resistors		
RM1	1 k Ω , 4-Station, 5-Pin, Single-Inline-Package Resistor Network	118001-102
RM2	2.2 k Ω , 4-Station, 5-Pin, Single-Inline-Package Resistor Network	118001-222
RM3	1 k Ω , 8-Station, 9-Pin, Single-Inline-Package Resistor Network	118002-102
RM4	2.2 k Ω , 4-Station, 5-Pin, Single-Inline-Package Resistor Network	118000-222
RM5	1 k Ω , 8-Station, 9-Pin, Single-Inline-Package Resistor Network	118002-102
RM6, RM7	2.2 k Ω , 4-Station, 5-Pin, Single-Inline-Package Resistor Network	118000-222
RM8	1 k Ω , 8-Station, 9-Pin, Single-Inline-Package Resistor Network	118002-102
RM10	1 k Ω , 4-Station, 5-Pin, Single-Inline-Package Resistor Network	118001-102
RM11, RM12	470 Ω , 4-Station, 5-Pin, Single-Inline-Package Resistor Network	118001-471
RM13	2.2 k Ω , 8-Station, 9-Pin, Single-Inline-Package Resistor Network	118002-222
RM14	1 k Ω , 4-Station, 5-Pin, Single-Inline-Package Resistor Network	118001-102
RM14-R16	1 k Ω , 4-Station, 5-Pin, Single-Inline-Package Resistor Network	118001-102
RM17-R20	2.2 k Ω , 8-Station, 9-Pin, Single-Inline-Package Resistor Network	118002-222
RM21-R23	1 k Ω , 4-Station, 5-Pin, Single-Inline-Package Resistor Network	118001-102
R1	1 k Ω , $\pm 5\%$, 1/4 W Resistor	110000-102
R2, R3	20 k Ω , $\pm 5\%$, 1/4 W Resistor	110000-203
R4, R5	10 k Ω , $\pm 5\%$, 1/4 W Resistor	110000-103
R6, R7	20 k Ω , $\pm 5\%$, 1/4 W Resistor	110000-203
R8	27 k Ω , $\pm 5\%$, 1/4 W Resistor	110000-273
R9-R11	20 k Ω , $\pm 5\%$, 1/4 W Resistor	110000-203
R12	330 k Ω , $\pm 5\%$, 1/4 W Resistor	110000-334
R13	120 k Ω , $\pm 5\%$, 1/4 W Resistor	110000-124
R14	75 k Ω , $\pm 5\%$, 1/4 W Resistor	110000-753
R15-R19	10 k Ω , $\pm 5\%$, 1/4 W Resistor	110000-103
R20	33 k Ω , $\pm 5\%$, 1/4 W Resistor	110000-333
R21	220 k Ω , $\pm 5\%$, 1/4 W Resistor	110000-224
R22	390 k Ω , $\pm 5\%$, 1/4 W Resistor	110000-394
R23	330 k Ω , $\pm 5\%$, 1/4 W Resistor	110000-334
R24	150 k Ω , $\pm 5\%$, 1/4 W Resistor	110000-154
R25	22 k Ω , $\pm 5\%$, 1/4 W Resistor	110000-223
R26	4.7 k Ω , $\pm 5\%$, 1/4 W Resistor	110000-472
R27	7.5 k Ω , $\pm 5\%$, 1/4 W Resistor	110000-752

 *New to Pole Position II.*

(Continued on next page)

Pole Position II
Namco Central Processing Unit Printed-Circuit Board Assembly
Parts List, continued

<i>Designator</i>	<i>Description</i>	<i>Part No.</i>
R28	22 k Ω , $\pm 5\%$, 1/4 W Resistor	110000-223
R29	15 k Ω , $\pm 5\%$, 1/4 W Resistor	110000-153
R30	15 k Ω , $\pm 5\%$, 1/4 W Resistor	110000-153
R31	22 k Ω , $\pm 5\%$, 1/4 W Resistor	110000-223
R32, R33	10 k Ω , $\pm 5\%$, 1/4 W Resistor	110000-103
R34	1 k Ω , $\pm 5\%$, 1/4 W Resistor	110000-102
R35-R37	10 k Ω , $\pm 5\%$, 1/4 W Resistor	110000-103
R37	1 k Ω , $\pm 5\%$, 1/4 W Resistor	110000-102
R38	22 k Ω , $\pm 5\%$, 1/4 W Resistor	110000-223
R40	15 k Ω , $\pm 5\%$, 1/4 W Resistor	110000-153
R41	22 k Ω , $\pm 5\%$, 1/4 W Resistor	110000-223
R42, 43	1 k Ω , $\pm 5\%$, 1/4 W Resistor	110000-102
R44	2.2 k Ω , $\pm 5\%$, 1/4 W Resistor	110000-222
R45, R46	1 k Ω , $\pm 5\%$, 1/4 W Resistor	110000-102
R47	2.2 k Ω , $\pm 5\%$, 1/4 W Resistor	110000-222
R48	470 Ω , $\pm 5\%$, 1/4 W Resistor	110000-471
R49	220 Ω , $\pm 5\%$, 1/4 W Resistor	110000-221
R50-R53	470 Ω , $\pm 5\%$, 1/4 W Resistor	110000-471
R54	1 k Ω , $\pm 5\%$, 1/4 W Resistor	110000-102
R55	4.7 k Ω , $\pm 5\%$, 1/4 W Resistor	110000-472
R56	47 Ω , $\pm 5\%$, 1/4 W Resistor	110000-470
R58	22 k Ω , $\pm 5\%$, 1/4 W Resistor	110000-223
R59	4.7 k Ω , $\pm 5\%$, 1/4 W Resistor	110000-472
R60	47 k Ω , $\pm 5\%$, 1/4 W Resistor	110000-473
R61	10 k Ω , $\pm 5\%$, 1/4 W Resistor	110000-103
R62	22 k Ω , $\pm 5\%$, 1/4 W Resistor	110000-223
R63	4.7 k Ω , $\pm 5\%$, 1/4 W Resistor	110000-472
R64	2.2 k Ω , $\pm 5\%$, 1/4 W Resistor	110000-222
R65	1 k Ω , $\pm 5\%$, 1/4 W Resistor	110000-102
R66	4.7 k Ω , $\pm 5\%$, 1/4 W Resistor	110000-472
R67	47 k Ω , $\pm 5\%$, 1/4 W Resistor	110000-473
R68	10 k Ω , $\pm 5\%$, 1/4 W Resistor	110000-103
R69	22 k Ω , $\pm 5\%$, 1/4 W Resistor	110000-223
R70	4.7 k Ω , $\pm 5\%$, 1/4 W Resistor	110000-472
R72	10 k Ω , $\pm 5\%$, 1/4 W Resistor	110000-103
R73	22 k Ω , $\pm 5\%$, 1/4 W Resistor	110000-223
R74	1 k Ω , $\pm 5\%$, 1/4 W Resistor	110000-102
R75	1.5 k Ω , $\pm 5\%$, 1/4 W Resistor	110000-152
R76	1 k Ω , $\pm 5\%$, 1/4 W Resistor	110000-102
R77	100 k Ω , $\pm 5\%$, 1/4 W Resistor	110000-104
R78	47 k Ω , $\pm 5\%$, 1/4 W Resistor	110000-473
R79	82 k Ω , $\pm 5\%$, 1/4 W Resistor	110000-823
R80	10 k Ω , $\pm 5\%$, 1/4 W Resistor	110000-103
R81	22 k Ω , $\pm 5\%$, 1/4 W Resistor	110000-223

(Continued on next page)

Pole Position II
Namco Central Processing Unit Printed-Circuit Board Assembly
Parts List, continued

<i>Designator</i>	<i>Description</i>	<i>Part No.</i>
R82	12 k Ω , $\pm 5\%$, 1/4 W Resistor	110000-123
R83	120 k Ω , $\pm 5\%$, 1/4 W Resistor	110000-124
R84	47 k Ω , $\pm 5\%$, 1/4 W Resistor	110000-473
R85	22 k Ω , $\pm 5\%$, 1/4 W Resistor	110000-223
R86	10 k Ω , $\pm 5\%$, 1/4 W Resistor	110000-103
R87	4.7 k Ω , $\pm 5\%$, 1/4 W Resistor	110000-472
R88	47 k Ω , $\pm 5\%$, 1/4 W Resistor	110000-473
R89	22 k Ω , $\pm 5\%$, 1/4 W Resistor	110000-223
R90	10 k Ω , $\pm 5\%$, 1/4 W Resistor	110000-103
R91	4.7 k Ω , $\pm 5\%$, 1/4 W Resistor	110000-472
R92	4.7 k Ω , $\pm 5\%$, 1/4 W Resistor	110000-472
R93	10 k Ω , $\pm 5\%$, 1/4 W Resistor	110000-103
R94	22 k Ω , $\pm 5\%$, 1/4 W Resistor	110000-223
R95	47 k Ω , $\pm 5\%$, 1/4 W Resistor	110000-473
R96, R97	22 k Ω , $\pm 5\%$, 1/4 W Resistor	110000-223
R98	15 k Ω , $\pm 5\%$, 1/4 W Resistor	110000-153
R99	180 k Ω , $\pm 5\%$, 1/4 W Resistor	110000-184
R100	120 k Ω , $\pm 5\%$, 1/4 W Resistor	110000-124
R101	22 k Ω , $\pm 5\%$, 1/4 W Resistor	110000-223
R102	15 k Ω , $\pm 5\%$, 1/4 W Resistor	110000-153
R103	1 k Ω , $\pm 5\%$, 1/4 W Resistor	110000-102
R104	100 Ω , $\pm 5\%$, 1/4 W Resistor	110000-101
R105	1 k Ω , $\pm 5\%$, 1/4 W Resistor	110000-102
R106	1 k Ω , $\pm 5\%$, 1/4 W Resistor	110000-102
R107	220 Ω , $\pm 5\%$, 1/4 W Resistor	110000-221
R108	1 k Ω , $\pm 5\%$, 1/4 W Resistor	110000-102
R109	1 k Ω , $\pm 5\%$, 1/4 W Resistor	110000-102
R110	2.2 k Ω , $\pm 5\%$, 1/4 W Resistor	110000-222
R111-R113	1 k Ω , $\pm 5\%$, 1/4 W Resistor	110000-102
R114	22 k Ω , $\pm 5\%$, 1/4 W Resistor	110000-223
R115-R117	1 k Ω , $\pm 5\%$, 1/4 W Resistor	110000-102
R118	330 Ω , $\pm 5\%$, 1/4 W Resistor	110000-331
R119-R121	1 k Ω , $\pm 5\%$, 1/4 W Resistor	110000-102
R122	330 Ω , $\pm 5\%$, 1/4 W Resistor	110000-331
R123	1 k Ω , $\pm 5\%$, 1/4 W Resistor	110000-102
R124	47 Ω , $\pm 5\%$, 1/4 W Resistor	110000-470
R125	470 Ω , $\pm 5\%$, 1/4 W Resistor	110000-471
R126	1 k Ω , $\pm 5\%$, 1/4 W Resistor	110000-102
R127	4.7 k Ω , $\pm 5\%$, 1/4 W Resistor	110000-472
R128	1 k Ω , $\pm 5\%$, 1/4 W Resistor	110000-102
R129	1 k Ω , $\pm 5\%$, 1/4 W Resistor	110000-102
R130	470 Ω , $\pm 5\%$, 1/4 W Resistor	110000-471
R131-R136	1 k Ω , $\pm 5\%$, 1/4 W Resistor	110000-102
R137	47 k Ω , $\pm 5\%$, 1/4 W Resistor	110000-473
R138	4.7 k Ω , $\pm 5\%$, 1/4 W Resistor	110000-472

(Continued on next page)

Pole Position II
Namco Central Processing Unit Printed-Circuit Board Assembly
Parts List, continued

<i>Designator</i>	<i>Description</i>	<i>Part No.</i>
Sockets		
1L	40-Contact Medium-Insertion-Force Integrated Circuit Socket	79-42C40
1E, 1F	28-Contact Medium-Insertion-Force Integrated Circuit Socket	79-42C28
2E, 2F	28-Contact Medium-Insertion-Force Integrated Circuit Socket	79-42C28
3D	42-Contact Medium-Insertion-Force Integrated Circuit Socket	79-42C42
3H	40-Contact Medium-Insertion-Force Integrated Circuit Socket	79-42C40
3L, 3M	28-Contact Medium-Insertion-Force Integrated Circuit Socket	79-42C28
4E	28-Contact Medium-Insertion-Force Integrated Circuit Socket	79-42C28
4L, 4M	28-Contact Medium-Insertion-Force Integrated Circuit Socket	79-42C28
5A	28-Contact Medium-Insertion-Force Integrated Circuit Socket	79-42C28
5H	24-Contact Medium-Insertion-Force Integrated Circuit Socket	79-42C24
5L, 5M	28-Contact Medium-Insertion-Force Integrated Circuit Socket	79-42C28
6A	28-Contact Medium-Insertion-Force Integrated Circuit Socket	79-42C28
6E, 6F	28-Contact Medium-Insertion-Force Integrated Circuit Socket	79-42C28
6H	28-Contact Medium-Insertion-Force Integrated Circuit Socket	79-42C28
6J	28-Contact Medium-Insertion-Force Integrated Circuit Socket	79-42C28
6L, 6M	28-Contact Medium-Insertion-Force Integrated Circuit Socket	79-42C28
7L, 7M	28-Contact Medium-Insertion-Force Integrated Circuit Socket	79-42C28
8D	42-Contact Medium-Insertion-Force Integrated Circuit Socket	79-42C42
8L, 8M	28-Contact Medium-Insertion-Force Integrated Circuit Socket	79-42C28
10D	42-Contact Medium-Insertion-Force Integrated Circuit Socket	79-42C42
10H	28-Contact Medium-Insertion-Force Integrated Circuit Socket	79-42C28
10L	40-Contact Medium-Insertion-Force Integrated Circuit Socket	79-42C40
Switches		
SW1	SPST Momentary-Contact Push-Button Switch	62-001
7E	8-Station, Single-Throw, Dual-Inline-Package Bit Switch	66-118P1T
9E	8-Station, Single-Throw, Dual-Inline-Package Bit Switch	66-118P1T
Transistors		
Q1	60 V, 350 mW, Type-2N3904 NPN Transistor*	34-2N3904
Q2	300 V, 500 mA, Type-MPS-A92 PNP Transistor*	33-MPSA92
Q3	60 V, 350 mW, Type-2N3904 NPN Transistor*	34-2N3904
Q4	40 V, 1 W, Type-2N3906 PNP Transistor*	33-2N3906
10F	Darlington Quad Transistor Array	137213-001
Miscellaneous		
BT1	6.3 V, 100 mA Nickel-Cadmium Battery	171038-001
J1	60-Pin Connector	179157-060
J2	3-Pin Power Connector	179156-003
	1/2-Inch Nylon Standoff	178050-008
	3/4-Inch Nylon Spacer	178020-750
	# M3 x 10mm Pan-Head Stainless Steel Machine Screw	176017-010
	# M3 Metric Split-Lock Washer	175006-002
	# M3 Metric Stainless Steel Flat Washer	175005-002
	# M3 Metric Stainless Steel Hex Nut	177005-002
	Printed-Circuit Board Brace	039562-01
	Test Point <i>Acceptable substitute is part no. 020670-01</i>	179051-001

* Orientation of leads not pin-compatible between Namco part and Atari part. See Schematic Package for pin configuration.

**Atari Pole Position II
Video Printed-Circuit Board Assembly
A039187-22 A
Parts List**

<i>Designator</i>	<i>Description</i>	<i>Part No.</i>
Capacitors		
C2	470 μ F, 25 V Aluminum Electrolytic Axial-Lead Capacitor <i>Acceptable substitute is part no. 24-100477</i>	24-160477
C3-C17	22 μ F, 16 V Aluminum Electrolytic Axial-Lead Capacitor <i>Acceptable substitute is part no. 24-250226 or 24-350226</i>	24-160226
C18-C57	0.1 μ F, + 80, -20%, 50 V Ceramic Disk Radial-Lead Capacitor	122002-104
C58	68 pF, 100 V Mica Capacitor	128002-680
C59	22 pF, 100 V Mica Capacitor	128002-220
C60	100 pF, 100 V Mica Capacitor	128002-101
Diodes		
CR1	Type-MV5053 Light-Emitting Diode	38-MV5053
CR2	Type-1N4735A, 6.2 V, 1 W Zener Diode	131009-001
Inductors		
L1-L3	1 μ H, 1/2 W Inductor	141007-001
L4	100 μ H, \pm 10% Inductor	141002-001
Integrated Circuits		
2A	Type-74LS138 Integrated Circuit	137177-001
2E	Type-74LS74 Integrated Circuit	37-74LS74
2H	Type-74LS139 Integrated Circuit	37-74LS139
2J	Type-74LS10 Integrated Circuit	37-74LS10
2K	Type-74LS368 Integrated Circuit	137168-001
3B	Type-74LS283 Integrated Circuit	137204-001
3C	Type-74LS283 Integrated Circuit	137204-001
3D	Type-74LS283 Integrated Circuit	137204-001
3H	Type-74LS175 Integrated Circuit	37-74LS175
3J, 4J	Type-74LS174 Integrated Circuit	37-74LS174
3K	Type-74LS283 Integrated Circuit	137204-001
3L	Type-74LS283 Integrated Circuit	137204-001
3M	Type-74LS02 Integrated Circuit	37-74LS02
4B	Type-74LS367 Integrated Circuit	37-74LS367
4C	Type-74LS367 Integrated Circuit	37-74LS367
4H	Type-74LS157 Integrated Circuit	37-74LS157
4K	Type-74LS174 Integrated Circuit	37-74LS174
4M, 5M	Type-74LS298 Integrated Circuit	137201-001
4N, 5N	Type-74LS283 Integrated Circuit	137204-001
5B	Type-74LS174 Integrated Circuit	37-74LS174
5C	Type-74LS174 Integrated Circuit	37-74LS174
5D	Type-74LS174 Integrated Circuit	37-74LS174
5E	Type-74LS245 Integrated Circuit	37-74LS245
5F, 6F	Type-74LS245 Integrated Circuit	37-74LS245

(Continued on next page)

**Atari Pole Position II
Video Printed-Circuit Board Assembly
Parts List, continued**

<i>Designator</i>	<i>Description</i>	<i>Part No.</i>
5H	Type-74LS175 Integrated Circuit	37-74LS175
5J	Type-74LS273 Integrated Circuit	37-74LS273
6A	Type-74S04 Integrated Circuit	37-74S04
6B	Type-74LS368 Integrated Circuit	137168-001
6C	Type-74LS08 Integrated Circuit	37-74LS08
6H	Type-74LS245 Integrated Circuit	37-74LS245
6J	Type-74LS245 Integrated Circuit	37-74LS245
6K	Type-74LS245 Integrated Circuit	37-74LS245
6M, 7M	Type-74LS273 Integrated Circuit	37-74LS273
7B	Type-74S163 Integrated Circuit <i>Acceptable substitute is part no. 137287-001 or -002</i>	137274-001
7C	Type-74S04 Integrated Circuit	37-74S04
7D	Type-74LS32 Integrated Circuit	37-74LS32
7L	Type-74LS273 Integrated Circuit	37-74LS273
8B	Type-74S00 Integrated Circuit	37-74S00
8C,9C	Type-74LS157 Integrated Circuit	37-74LS157
8D	Type-74LS158 Integrated Circuit	137312-001
8E	Type-74LS158 Integrated Circuit	137203-001
8L,9L	Type-74LS174 Integrated Circuit	37-74LS174
9B	Type-74LS20 Integrated Circuit	37-74LS20
9D	Type-74LS298 Integrated Circuit	137201-001
9E, 10E	Type-74LS257 Integrated Circuit	37-74LS257
9H	Type-74LS161 Integrated Circuit	137287-001
9J	Type-74LS161 Integrated Circuit	137287-001
9K	Type-7497 Integrated Circuit	37-7497
9M, 10M	Type-74LS283 Integrated Circuit	137204-001
9N	Type-74LS85 Integrated Circuit	37-74LS85
10B	Type-74LS74 Integrated Circuit	37-74LS74
10C	Type-74LS174 Integrated Circuit	37-74LS174
10D	Type-74LS368 Integrated Circuit	137168-001
10H	Type-74LS161 Integrated Circuit	137287-001
10J	Type-74LS161 Integrated Circuit	137287-001
10K	Type-74LS161 Integrated Circuit	137287-001
10L	Type-74LS161 Integrated Circuit	137287-001
10N	Type-74LS85 Integrated Circuit	37-74LS85
11B	Type-74107 Integrated Circuit <i>Acceptable substitute is part no. 137169-001</i>	37-74107
11F	Type-74LS174 Integrated Circuit	37-74LS174
11H	Type-74LS174 Integrated Circuit	37-74LS174
11J	Type-74LS273 Integrated Circuit	37-74LS273
11K	Type-74LS139 Integrated Circuit	37-74LS139
11L	Type-74LS373 Integrated Circuit	37-74LS373

➤ *New to Pole Position II.*

(Continued on next page)









**Atari Pole Position II
Video Printed-Circuit Board Assembly
Parts List, continued**

Designator	Description	Part No.
11M	Type-74LS373 Integrated Circuit	37-74LS373
12B	Type-74LS08 Integrated Circuit	37-74LS08
12F	Type-74LS86 Integrated Circuit	37-74LS86
13F	Type-74LS20 Integrated Circuit	37-74LS20
<i>For -22 version only</i>		
2F	Type-07 Custom Integrated Circuit	137193-001
3N	Type-02 Custom Integrated Circuit	137190-001
4D	Type-09 Custom Integrated Circuit	137282-001
5L, 6L	Type-03 Custom Integrated Circuit	137283-001
7E	Type-04 Custom Integrated Circuit	137191-001
8N	Type-02 Custom Integrated Circuit	137190-001
13H	Type-02 Custom Integrated Circuit	137190-001
Random-Access Memories		
7F, 8F	Type-2114-2 (200 ns) Random-Access Memory	90-7036
7H, 8H	55 ns Random-Access Memory	137199-001
7J, 8J	Type-2114-2 (200 ns) Random-Access Memory	90-7036
7K, 8K	Type-2114-2 (200 ns) Random-Access Memory	90-7036
9F, 10F	55 ns Random-Access Memory	137199-001
Programmable Read-Only Memories		
2B	Type-82S129 Programmable Read-Only Memory	136014-144
2C	Type-82S129 Programmable Read-Only Memory	136014-143
2D	Type-82S129 Programmable Read-Only Memory	136014-142
6D	Type-82S123 Programmable Read-Only Memory	136014-136
6E	Type-82S123 Programmable Read-Only Memory	136014-135
<i>For -22 version only</i>		
2L	Electrically Programmable Read-Only Memory <i>Acceptable substitute is part no. 136014-158</i>	136014-127
2M	Electrically Programmable Read-Only Memory <i>Acceptable substitute is part no. 136014-159</i>	136014-128
2N	Electrically Programmable Read-Only Memory	136014-134
3E, 4E	Random-Access Memory (200 ns) <i>Acceptable substitute is part no. 137211-001</i>	137198-001
4L	Type-82S137 Programmable Read-Only Memory	136014-191
5K	Type-82S129 Programmable Read-Only Memory	136014-190
8M	Type-82S129 Programmable Read-Only Memory	136014-189
11C	Type-82S129 Programmable Read-Only Memory	136014-188
11D	Type-82S129 Programmable Read-Only Memory	136014-187
11E	Type-82S129 Programmable Read-Only Memory	136014-186
12H	Type-82S137 Programmable Read-Only Memory	136014-192
3F, 4F	Random-Access Memory (200 ns) <i>Acceptable substitute is part no. 137211-001</i>	137198-001
6N	Electrically Programmable Read-Only Memory	136014-173
7N	Electrically Programmable Read-Only Memory	136014-172
11N	Electrically Programmable Read-Only Memory	136014-231

 New to Pole Position II.

(Continued on next page)

Atari Pole Position II Video Printed-Circuit Board Assembly Parts List, continued

Designator	Description	Part No.
12J	Electrically Programmable Read-Only Memory <i>Acceptable substitute is part no. 136014-151</i>	136014-120
12K	 Electrically Programmable Read-Only Memory	136014-167
12L	 Electrically Programmable Read-Only Memory	136014-169
12M	 Electrically Programmable Read-Only Memory	136014-174
12N	 Electrically Programmable Read-Only Memory	136014-171
13J	Electrically Programmable Read-Only Memory <i>Acceptable substitute is part no. 136014-150</i>	136014-119
13K	 Electrically Programmable Read-Only Memory	136014-166
13L	 Electrically Programmable Read-Only Memory	136014-168
13M	 Electrically Programmable Read-Only Memory	136014-175
13N	 Electrically Programmable Read-Only Memory	136014-170
Resistors		
R1-R9	2.2 k Ω , $\pm 5\%$, 1/4 W Resistor	110000-222
R10-R24	1 k Ω , $\pm 5\%$, 1/4 W Resistor	110000-102
R25-R40	470 Ω , $\pm 5\%$, 1/4 W Resistor	110000-471
R41-R48	4.7 k Ω , $\pm 5\%$, 1/4 W Resistor	110000-472
R49-R52	1 k Ω , $\pm 5\%$, 1/4 W Resistor	110000-102
R55-R58	1 k Ω , $\pm 5\%$, 1/4 W Resistor	110000-102
R59	220 Ω , $\pm 5\%$, 1/4 W Resistor	110000-221
R60	470 Ω , $\pm 5\%$, 1/4 W Resistor	110000-471
R61	1 k Ω , $\pm 5\%$, 1/4 W Resistor	110000-102
R62	2.2 k Ω , $\pm 5\%$, 1/4 W Resistor	110000-222
R63	1 k Ω , $\pm 5\%$, 1/4 W Resistor	110000-102
R64, R65	82 Ω , $\pm 5\%$, 1/4 W Resistor	110000-820
R66	220 Ω , $\pm 5\%$, 1/4 W Resistor	110000-221
R67	470 Ω , $\pm 5\%$, 1/4 W Resistor	110000-471
R68	1 k Ω , $\pm 5\%$, 1/4 W Resistor	110000-102
R69	2.2 k Ω , $\pm 5\%$, 1/4 W Resistor	110000-222
R70	1 k Ω , $\pm 5\%$, 1/4 W Resistor	110000-102
R71, R72	82 Ω , $\pm 5\%$, 1/4 W Resistor	110000-820
R73	220 Ω , $\pm 5\%$, 1/4 W Resistor	110000-221
R74	470 Ω , $\pm 5\%$, 1/4 W Resistor	110000-471
R75	1 k Ω , $\pm 5\%$, 1/4 W Resistor	110000-102
R76	2.2 k Ω , $\pm 5\%$, 1/4 W Resistor	110000-222
R77	1 k Ω , $\pm 5\%$, 1/4 W Resistor	110000-102
R78, R79	82 Ω , $\pm 5\%$, 1/4 W Resistor	110000-820
R80	1 k Ω , $\pm 5\%$, 1/4 W Resistor	110000-102
R81	100 Ω , $\pm 5\%$, 1/4 W Resistor	110000-101
R82-R85	1 k Ω , $\pm 5\%$, 1/4 W Resistor	110000-102
R86	220 Ω , $\pm 5\%$, 1/4 W Resistor	110000-221
R87-R98	1 k Ω $\pm 5\%$, 1/4 W Resistor	110000-102

 *New to Pole Position II.*

(Continued on next page)

Atari Pole Position II Video Printed-Circuit Board Assembly Parts List, continued

Designator	Description	Part No.
R99	10 k Ω , $\pm 5\%$, 1/4 W Resistor	110000-103
R100	220 Ω , $\pm 5\%$, 1/4 W Resistor	110000-221
R101	10 k Ω , $\pm 5\%$, 1/4 W Resistor	110000-103
R102	470 Ω , $\pm 5\%$, 1/4 W Resistor	110000-102
R106	150 Ω , $\pm 5\%$, 1/4 W Resistor	110000-151
R107, R1099	1 k Ω , $\pm 5\%$, 1/4 W Resistor	110000-102
R108, R1100	100 Ω , $\pm 5\%$, 1/4 W Resistor	110000-101
1B	2.2 k Ω , $\pm 2\%$, 15-Element, Dual-Inline Package Resistor Pack	118003-222
1K	2.2 k Ω , $\pm 2\%$, 15-Element, Dual-Inline Package Resistor Pack	118003-222
Sockets		
2F	28-Contact Medium-Insertion-Force Integrated Circuit Socket	79-42C28
2L	28-Contact Medium-Insertion-Force Integrated Circuit Socket	79-42C28
2M	28-Contact Medium-Insertion-Force Integrated Circuit Socket	79-42C28
2N	24-Contact Medium-Insertion-Force Integrated Circuit Socket	79-42C24
3E, 4E	24-Contact Medium-Insertion-Force Integrated Circuit Socket	79-42C24
3F, 4F	24-Contact Medium-Insertion-Force Integrated Circuit Socket	79-42C24
3N	28-Contact Medium-Insertion-Force Integrated Circuit Socket	79-42C28
4D	24-Contact Medium-Insertion-Force Integrated Circuit Socket	79-42C24
4L	16-Contact Medium-Insertion-Force Integrated Circuit Socket	79-42C16
5K	16-Contact Medium-Insertion-Force Integrated Circuit Socket	79-42C16
5L, 6L	18-Contact Medium-Insertion-Force Integrated Circuit Socket	79-42C18
6N, 7N	28-Contact Medium-Insertion-Force Integrated Circuit Socket	79-42C28
7E	28-Contact Medium-Insertion-Force Integrated Circuit Socket	79-42C28
8M	16-Contact Medium-Insertion-Force Integrated Circuit Socket	79-42C16
8N	28-Contact Medium-Insertion-Force Integrated Circuit Socket	79-42C28
11C	16-Contact Medium-Insertion-Force Integrated Circuit Socket	79-42C16
11D	16-Contact Medium-Insertion-Force Integrated Circuit Socket	79-42C16
11E	16-Contact Medium-Insertion-Force Integrated Circuit Socket	79-42C16
11N	24-Contact Medium-Insertion-Force Integrated Circuit Socket	79-42C24
12H	18-Contact Medium-Insertion-Force Integrated Circuit Socket	79-42C18
12J, 13J	28-Contact Medium-Insertion-Force Integrated Circuit Socket	79-42C28
12K, 13K	28-Contact Medium-Insertion-Force Integrated Circuit Socket	79-42C28
12L, 13L	28-Contact Medium-Insertion-Force Integrated Circuit Socket	79-42C28
12M	28-Contact Medium-Insertion-Force Integrated Circuit Socket	79-42C28
12N, 13N	28-Contact Medium-Insertion-Force Integrated Circuit Socket	79-42C28
13H	28-Contact Medium-Insertion-Force Integrated Circuit Socket	79-42C28
13M	28-Contact Medium-Insertion-Force Integrated Circuit Socket	79-42C28
Transistors		
Q1-Q4	Type-2N3904, 60 V, 1 W, NPN Transistor	34-2N3904
Q5-Q7	Type-2N3906, 40 V, 1 W, PNP Transistor	33-2N3906
Miscellaneous		
	Test Points <i>Acceptable substitute is part no. 020670-01</i>	179051-002
W1, W2	0 Ω Jumper Resistor	110005-001
Y1B	24.576 MHz Crystal <i>Acceptable substitute is part no. 144004-002</i>	144004-003

 New to Pole Position II.

Pole Position II
Namco Video Printed-Circuit Board Assembly
171032-001 A

<i>Designator</i>	<i>Description</i>	<i>Part No.</i>
Capacitors		
C1	220 μ F 16 V Aluminum Electrolytic Axial-Lead Capacitor	24-160227
C2	0.1 μ F, 50 V, +80, -20% Ceramic Capacitor	122002-104
C3	1000 μ F 25 V Aluminum Electrolytic Axial-Lead Capacitor	24-250108
C4	22 μ F 16 V Aluminum Electrolytic Axial-Lead Capacitor	24-160226
C5	220 μ F 16 V Aluminum Electrolytic Axial-Lead Capacitor	24-160227
C6	0.1 μ F, 100 V Mylar Capacitor	21-101104
C7, C8	0.15 μ F, \pm 10%, 25 V Solid Tantalum Radial-Lead Capacitor	121018-154
C9	0.1 μ F, 50 V, +80, -20% Ceramic Capacitor	122002-104
C10	22 μ F 16 V Aluminum Electrolytic Axial-Lead Capacitor	24-160226
C11	220 μ F 16 V Aluminum Electrolytic Axial-Lead Capacitor	24-160227
C12	0.1 μ F, 100 V Mylar Capacitor	21-101104
C13, C14	0.15 μ F, \pm 10%, 25 V Solid Tantalum Radial-Lead Capacitor	121018-154
C15	0.1 μ F, 50 V, +80, -20% Ceramic Capacitor	122002-104
C16	22 μ F 16 V Aluminum Electrolytic Axial-Lead Capacitor	24-160226
C17	220 μ F 16 V Aluminum Electrolytic Axial-Lead Capacitor	24-160227
C18	0.1 μ F, 100 V Mylar Capacitor	21-101104
C19, C20	0.15 μ F, \pm 10%, 25 V Solid Tantalum Radial-Lead Capacitor	121018-154
C21	0.1 μ F, 50 V, +80, -20% Ceramic Capacitor	122002-104
C22	22 μ F 16 V Aluminum Electrolytic Axial-Lead Capacitor	24-160226
C23	220 μ F 16 V Aluminum Electrolytic Axial-Lead Capacitor	24-160227
C24	0.1 μ F, 100 V Mylar Capacitor	21-101104
C25, C26	0.15 μ F, \pm 10%, 25 V Solid Tantalum Radial-Lead Capacitor	121018-154
C27	0.1 μ F, 50 V, +80, -20% Ceramic Capacitor	122002-104
C34	220 pF, 100 V Fixed Mica Radial-Lead Capacitor	128002-221
C41-C44	1000 pF, 100 V Ceramic Axial-Lead Capacitor	122016-102
C51-C55	0.1 μ F, 50 V, +80, -20% Ceramic Capacitor	122002-104
C56	4.7 μ F, \pm 20%, 16 V Solid Tantalum Radial-Lead Capacitor	121014-475
C57	0.1 μ F, 50 V, +80, -20% Ceramic Capacitor	122002-104
C58	4.7 μ F, \pm 20%, 16 V Solid Tantalum Radial-Lead Capacitor	121014-475
C59-C61	0.1 μ F, 50 V, +80, -20% Ceramic Capacitor	122002-104
C62	4.7 μ F, \pm 20%, 16 V Solid Tantalum Radial-Lead Capacitor	121014-475
C63	0.1 μ F, 50 V, +80, -20% Ceramic Capacitor	122002-104
C64	4.7 μ F, \pm 20%, 16 V Solid Tantalum Radial-Lead Capacitor	121014-475
C65-C67	0.1 μ F, 50 V, +80, -20% Ceramic Capacitor	122002-104
C68	4.7 μ F, \pm 20%, 16 V Solid Tantalum Radial-Lead Capacitor	121014-475
C69-C71	0.1 μ F, 50 V, +80, -20% Ceramic Capacitor	122002-104
C70	4.7 μ F, \pm 20%, 16 V Solid Tantalum Radial-Lead Capacitor	121014-475
C72	4.7 μ F, \pm 20%, 16 V Solid Tantalum Radial-Lead Capacitor	121014-475
C73	0.1 μ F, 50 V, +80, -20% Ceramic Capacitor	122002-104
C74	0.1 μ F, 50 V, +80, -20% Ceramic Capacitor	122002-104
C75	4.7 μ F, \pm 20%, 16 V Solid Tantalum Radial-Lead Capacitor	121014-475
C76-C79	0.1 μ F, 50 V, +80, -20% Ceramic Capacitor	122002-104
C80	4.7 μ F, \pm 20%, 16 V Solid Tantalum Radial-Lead Capacitor	121014-475
C81	0.1 μ F, 50 V, +80, -20% Ceramic Capacitor	122002-104

(Continued on next page)

Pole Position II
Namco Video Printed-Circuit Board Assembly
Parts List, continued

<i>Designator</i>	<i>Description</i>	<i>Part No.</i>
C82	4.7 μ F, \pm 20%, 16 V Solid Tantalum Radial-Lead Capacitor	121014-475
C83	0.1 μ F, 50 V, +80, -20% Ceramic Capacitor	122002-104
C84	4.7 μ F, \pm 20%, 16 V Solid Tantalum Radial-Lead Capacitor	121014-475
C85	0.1 μ F, 50 V, +80, -20% Ceramic Capacitor	122002-104
C86	4.7 μ F, \pm 20%, 16 V Solid Tantalum Radial-Lead Capacitor	121014-475
C87	0.1 μ F, 50 V, +80, -20% Ceramic Capacitor	122002-104
<i>Integrated Circuits</i>		
1B	Type-02 Custom Integrated Circuit	137190-001
1C	Type-74LS283 Integrated Circuit	137204-001
1D	Type-74LS283 Integrated Circuit	137204-001
1J	Type-74LS85 Integrated Circuit	37-74LS85
1K	Type-74LS85 Integrated Circuit	37-74LS85
1M	Type-02 Custom Integrated Circuit	137190-001
2B	Type-74LS02 Integrated Circuit	37-74LS02
2C	Type-74LS298 Integrated Circuit	137201-001
2D	Type-74LS298 Integrated Circuit	137201-001
2E	Type-74LS273 Integrated Circuit	37-74LS273
2F, 3F	Type-74LS273 Integrated Circuit	37-74LS273
2J	Type-74LS283 Integrated Circuit	137204-001
2K	Type-74LS283 Integrated Circuit	137204-001
2L	Type-74LS373 Integrated Circuit	37-74LS373
3B, 4B	Type-74LS283 Integrated Circuit	137204-001
3D	Type-03 Custom Integrated Circuit	137283-001
3E	Type-03 Custom Integrated Circuit	137283-001
3H	Type-74LS174 Integrated Circuit	37-74LS174
3J	Type-74LS174 Integrated Circuit	37-74LS174
3K-6K	Type-74LS161 Integrated Circuit	37-74LS161
3L	Type-74LS375 Integrated Circuit <i>Acceptable substitute is part no. 137286-002</i>	137286-001
4A	Type-74LS368 Integrated Circuit	137168-001
4C, 5C	Type-74LS174 Integrated Circuit	37-74LS174
4E-7E	Type-74LS245 Integrated Circuit	37-74LS245
4J	Type-7497 Integrated Circuit	37-7497
4L	Type-74LS139 Integrated Circuit	37-74LS139
5A	Type-74LS10 Integrated Circuit	37-74LS10
5B	Type-74LS174 Integrated Circuit	37-74LS174
5D	Type-74LS273 Integrated Circuit	37-74LS273
5J, 6J	Type-74LS161 Integrated Circuit	37-74LS161
5L	Type-74LS273 Integrated Circuit	37-74LS273
6A	Type-74LS139 Integrated Circuit	37-74LS139
6B	Type-74LS175 Integrated Circuit	37-74LS175
6C	Type-74LS157 Integrated Circuit	37-74LS157
6D	Type-74LS175 Integrated Circuit	37-74LS175
6L, 7L	Type-74LS174 Integrated Circuit	37-74LS174
6N	Type-02 Custom Integrated Circuit	137190-001
7A	Type-07 Custom Integrated Circuit	137193-001

(Continued on next page)

















Pole Position II
Namco Video Printed-Circuit Board Assembly
Parts List, continued

<i>Designator</i>	<i>Description</i>	<i>Part No.</i>
7D, 8D	Type-74LS245 Integrated Circuit	37-74LS245
7M	Type-74LS86 Integrated Circuit	37-74LS86
7N	Type-74LS20 Integrated Circuit	37-74LS20
8A	Type-74LS74 Integrated Circuit	37-74LS74
8F	Type-04 Custom Integrated Circuit	137191-001
8H	Type-74LS158 Integrated Circuit	137203-001
8J	Type-74LS257 Integrated Circuit	37-74LS257
8K	Type-74LS257 Integrated Circuit	37-74LS257
8N-11N	10 W Audio Power Amplifier Integrated Circuit	137215-001
9B-11B	Type-74LS283 Integrated Circuit	137204-001
9C	Type-09 Custom Integrated Circuit	137282-001
9D-11D	Type-74LS174 Integrated Circuit	37-74LS174
9F	Type-74LS32 Integrated Circuit	37-74LS32
9H, 10H	Type-74LS157 Integrated Circuit	37-74LS157
9J	Type-74LS298 Integrated Circuit	137201-001
9K	Type-74LS368 Integrated Circuit	137168-001
10C, 11C	Type-74LS367 Integrated Circuit	37-74LS367
10E	Type-74LS08 Integrated Circuit	37-74LS08
10F	Type-74S04 Integrated Circuit	37-74S04
10J	Type-74LS157 Integrated Circuit	37-74LS157
10K	Type-74LS174 Integrated Circuit	37-74LS174
11E	Type-74LS368 Integrated Circuit	137168-001
11F	Type-74S163 Integrated Circuit <i>Acceptable substitutes are part nos.</i> <i>137287-001 & 137287-002</i>	137274-001
11H	Type-74S00 Integrated Circuit	37-74S00
11J	Type-74LS20 Integrated Circuit	37-74LS20
11K	Type-74LS74 Integrated Circuit	37-74LS74
12B	Type-74LS138 Integrated Circuit	137177-001
12F	Type-74S04 Integrated Circuit	37-74S04
Diode		
D1	Type-1N4735A, 6.2 V, 1 W Zener Diode	131009-001
Random-Access Memories		
7B, 8B	Static-2048 x 8 Random-Access Memory (200 ns) <i>Acceptable substitute is</i> <i>part no. 137211-001 (150 ns)</i>	137198-001
7C, 8C	Static-2048 x 8 Random-Access Memory (200 ns) <i>Acceptable substitute is</i> <i>part no. 137211-001 (150 ns)</i>	137198-001
4F-7F	Static-1024 x 4 Random-Access Memory (200 ns)	90-7036
4H-7H	Static-1024 x 4 Random-Access Memory (200 ns)	90-7036
7J	Static-1024 x 4 Random-Access Memory (55 ns)	137199-001
7K	Static-1024 x 4 Random-Access Memory (55 ns)	137199-001

 *New to Pole Position II.*

(Continued on next page)

Pole Position II
Namco Video Printed-Circuit Board Assembly
Parts List, continued

<i>Designator</i>	<i>Description</i>	<i>Part No.</i>
Programmable Read-Only Memories		
1A	Electrically Programmable Read-Only Memory 32	136014-134
1E	 Electrically Programmable Read-Only Memory 29	136014-173
1F	 Electrically Programmable Read-Only Memory 28	136014-172
1L	Electrically Programmable Read-Only Memory 27	136014-231
1M	 Electrically Programmable Read-Only Memory 26	136014-171
1N	 Electrically Programmable Read-Only Memory 25	136014-170
2A	Electrically Programmable Read-Only Memory 31	136014-128
2H	 Programmable Read-Only Memory 10	136014-189
2M	 Programmable Read-Only Memory 12	136014-174
2N	 Programmable Read-Only Memory 12	136014-175
3A	Electrically Programmable Read-Only Memory 30	136014-127
3C	 Programmable Read-Only Memory 12	136014-191
3M	 Electrically Programmable Read-Only Memory 22	136014-169
3N	 Electrically Programmable Read-Only Memory 21	136014-168
4D	 Programmable Read-Only Memory 11	136014-190
4M	 Electrically Programmable Read-Only Memory 20	136014-167
4N	 Electrically Programmable Read-Only Memory 19	136014-166
5M	Electrically Programmable Read-Only Memory 18	136014-120
5N	Electrically Programmable Read-Only Memory 17	136014-119
6M	 Programmable Read-Only Memory 6	136014-192
8E	Programmable Read-Only Memory 13	136014-135
8L	 Programmable Read-Only Memory 7	136014-186
9A	Programmable Read-Only Memory 15	136014-142
9E	Programmable Read-Only Memory 14	136014-136
9L	 Programmable Read-Only Memory 8	136014-187
10A	Programmable Read-Only Memory 16	136014-143
10L	 Programmable Read-Only Memory 9	136014-188
11A	Programmable Read-Only Memory 17	136014-144
Resistors		
R1-R8	1 k Ω , $\pm 5\%$, 1/4 W Resistor	110000-102
R9	330 Ω , $\pm 5\%$, 1/4 W Resistor	110000-331
R10	330 Ω , $\pm 5\%$, 1/4 W Resistor	110000-331
R11-R15	1 k Ω , $\pm 5\%$, 1/4 W Resistor	110000-102
R16	220 Ω , $\pm 5\%$, 1/4 W Resistor	110000-221
R17	470 Ω , $\pm 5\%$, 1/4 W Resistor	110000-471
R18	1 k Ω , $\pm 5\%$, 1/4 W Resistor	110000-102
R19	2.2 k Ω , $\pm 5\%$, 1/4 W Resistor	110000-222
R20	220 Ω , $\pm 5\%$, 1/4 W Resistor	110000-221
R21	470 Ω , $\pm 5\%$, 1/4 W Resistor	110000-471
R22	1 k Ω , $\pm 5\%$, 1/4 W Resistor	110000-102
R23	2.2 k Ω , $\pm 5\%$, 1/4 W Resistor	110000-222

 New to Pole Position II.

(Continued on next page)

Pole Position II
Namco Video Printed-Circuit Board Assembly
Parts List, continued

<i>Designator</i>	<i>Description</i>	<i>Part No.</i>
R24	220 Ω , $\pm 5\%$, 1/4 W Resistor	110000-221
R25	470 Ω , $\pm 5\%$, 1/4 W Resistor	110000-471
R26	1 k Ω , $\pm 5\%$, 1/4 W Resistor	110000-102
R27	2.2 k Ω , $\pm 5\%$, 1/4 W Resistor	110000-222
R28	1 k Ω , $\pm 5\%$, 1/4 W Resistor	110000-102
R29	1 k Ω Horizontal Potentiometer	119003-102
R30	1 k Ω , $\pm 5\%$, 1/4 W Resistor	110000-102
R31	1 k Ω Horizontal Potentiometer	119003-102
R32	1 k Ω Horizontal Potentiometer	119003-102
R33, R34	1 k Ω , $\pm 5\%$, 1/4 W Resistor	110000-102
R35	1 k Ω Horizontal Potentiometer	119003-102
R36	1 k Ω , $\pm 5\%$, 1/4 W Resistor	110000-102
R37	100 Ω , $\pm 5\%$, 1/4 W Resistor	110000-101
R40	1 k Ω , $\pm 5\%$, 1/4 W Resistor	110000-102
RM1-RM3	1 k Ω , 4-Station, 5-Pin, Single-Inline-Package Resistor Network	118001-102
RM10	1 k Ω , 4-Station, 5-Pin, Single-Inline-Package-Resistor Network	118001-102
RM11, RM12	470 Ω , 8-Station, 9-Pin, Single-Inline-Package Resistor Network	118002-471
RM13, RM14	1 k Ω , 4-Station, 5-Pin, Single-Inline-Package-Resistor Network	118001-102
RM4	4.7 k Ω , 8-Station, 9-Pin, Single-Inline-Package Resistor Network	118002-472
RM5-RM9	2.2 k Ω , 8-Station, 9-Pin, Single-Inline-Package Resistor Network	118002-222
VR1-VR4	1 k Ω , $\pm 20\%$ Horizontal Trimming Potentiometer	119003-102

Sockets

1A	24-Contact Medium-Insertion-Force Integrated Circuit Socket	79-42C24
1B	28-Contact Medium-Insertion-Force Integrated Circuit Socket	79-42C28
1E	28-Contact Medium-Insertion-Force Integrated Circuit Socket	79-42C28
1F	28-Contact Medium-Insertion-Force Integrated Circuit Socket	79-42C28
1H	28-Contact Medium-Insertion-Force Integrated Circuit Socket	79-42C28
1L	24-Contact Medium-Insertion-Force Integrated Circuit Socket	79-42C24
1M-5M	28-Contact Medium-Insertion-Force Integrated Circuit Socket	79-42C28
1N-6N	28-Contact Medium-Insertion-Force Integrated Circuit Socket	79-42C28
2A, 3A	28-Contact Medium-Insertion-Force Integrated Circuit Socket	79-42C28
2H	16-Contact Medium-Insertion-Force Integrated Circuit Socket	79-42C16
2M	28-Contact Medium-Insertion-Force Integrated Circuit Socket	79-42C28
2N	28-Contact Medium-Insertion-Force Integrated Circuit Socket	79-42C28
3C	18-Contact Medium-Insertion-Force Integrated Circuit Socket	79-42C18
3D	18-Contact Medium-Insertion-Force Integrated Circuit Socket	79-42C18
3E	18-Contact Medium-Insertion-Force Integrated Circuit Socket	79-42C18
4D	16-Contact Medium-Insertion-Force Integrated Circuit Socket	79-42C16
6M	18-Contact Medium-Insertion-Force Integrated Circuit Socket	79-42C18
7A	28-Contact Medium-Insertion-Force Integrated Circuit Socket	79-42C28
8C	28-Contact Medium-Insertion-Force Integrated Circuit Socket	79-42C28
8F	28-Contact Medium-Insertion-Force Integrated Circuit Socket	79-42C28
8L-10L	16-Contact Medium-Insertion-Force Integrated Circuit Socket	79-42C16
9C	24-Contact Medium-Insertion-Force Integrated Circuit Socket	79-42C24

 New to Pole Position II.

(Continued on next page)

**Pole Position II
Namco Video Printed-Circuit Board Assembly
Parts List, continued**

<i>Designator</i>	<i>Description</i>	<i>Part No.</i>
Miscellaneous		
J1	60-Pin Connector	179157-060
J2	3-Pin Power Connector	179156-003
X1	24.576 MHz Crystal <i>Acceptable substitute is part no. 144004-002</i>	144004-003
	Test Points <i>Acceptable substitute is part no. 020670-01</i>	179051-001
	Heat Sink	039566-01
	Printed-Circuit Board Brace	039562-01
	Printed-Circuit Board Interconnector Cable Assy.	171036-001
Metric Screws and Washers		
	#M3 x 6mm Pan-Head Stainless Steel Machine Screw	176017-006
	#M3 x 8mm Pan-Head Stainless Steel Machine Screw	176017-008
	#M3 x 10mm Pan-Head Stainless Steel Machine Screw	176017-010
	#M3 Stainless Steel Flat Washer	175005-002
	#M3 Stainless Steel Split-Lock Washer	175006-002
	#M3 Metric Stainless Steel Hex Nut	177005-002

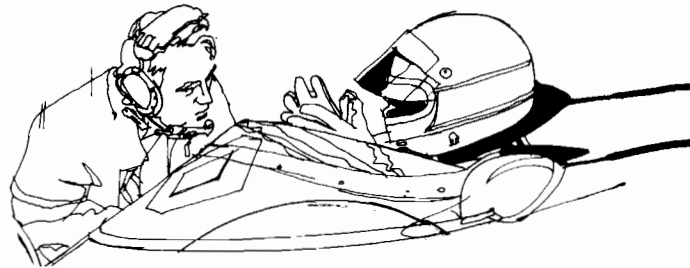

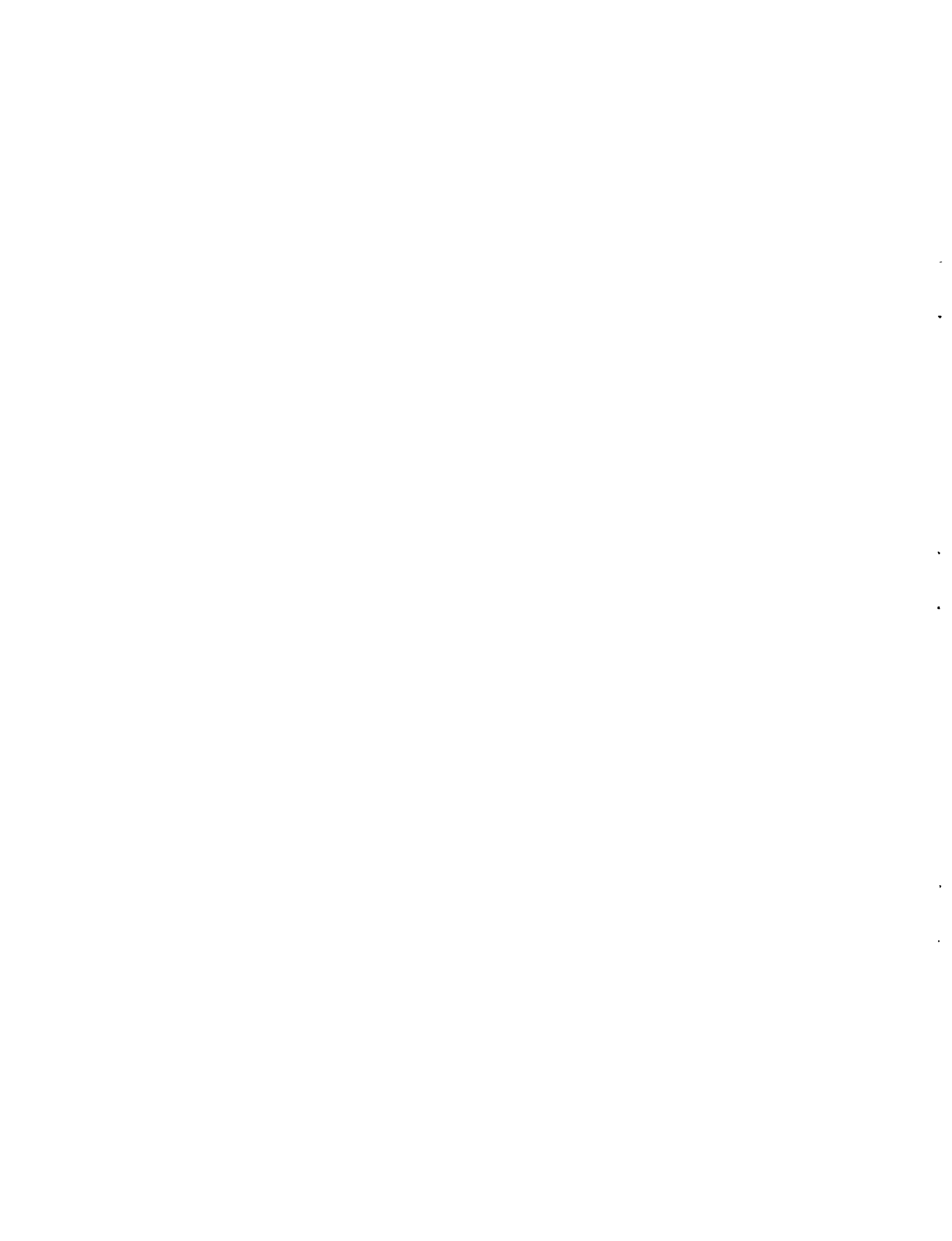

4 Schematic Changes



Schematic documentation for **Pole Position** is shipped with your game. If your game has an Atari PCB game set, this information is contained in SP-218. If your game has a Namco PCB game set, this information is contained in SP-219.

To convert these schematic packages so they support **Pole Position II**, delete the type numbers of the integrated circuits listed in Tables 4-1 and 4-2.

NOTE

Refer to the CPU PCB and Video PCB illustrated parts lists in this document for the proper description and type numbers of the integrated circuits used in Pole Position II.

Table 4-1 SP-218 Schematic Package Changes

Circuit Name	IC Location	Page in SP-218
Microprocessor A	4E, 4D, 3E, 3D	Sheet 5A
Microprocessor B	4L, 4K, 3L, 3K	Sheet 5B
Sound Microprocessor	7H, 7F	Sheet 6A
Speech Processor and Memory	9C, 9A, 8C	Sheet 9A
Vertical Position Modifiers	2D, 2C, 2B	Sheet 11B
Roadway Memory and Adders	2M, 2N, 2L	Sheet 12B
Alphanumeric and Background PROM	5K, 4L, 6N, 7N	Sheet 13A
Match Circuit	11N	Sheet 14A
Picture Memory (Signs and Cars)	12J, 13J, 12K, 13K, 12L, 13L, 12M, 13M, 12N, 13N	Sheet 14B

Table 4-2 SP-219 Schematic Package Changes

Circuit Name	IC Location	Page in SP-219
Microprocessor A	8L, 7L, 8M, 7M	Sheet 5A
Sound Microprocessor	6H, 5H	Sheet 6A
Speech Processor and Memory	2E, 1E, 2F, 1F	Sheet 9A
Roadway Memory and Adders	2A, 1A, 3A	Sheet 12B
Alphanumeric and Background PROM	1E, 1F	Sheet 13A
Picture Memory (Signs and Cars)	5M, 5N, 4M, 4N, 3M, 3N, 2M, 2N, 1M, 1N	Sheet 14B

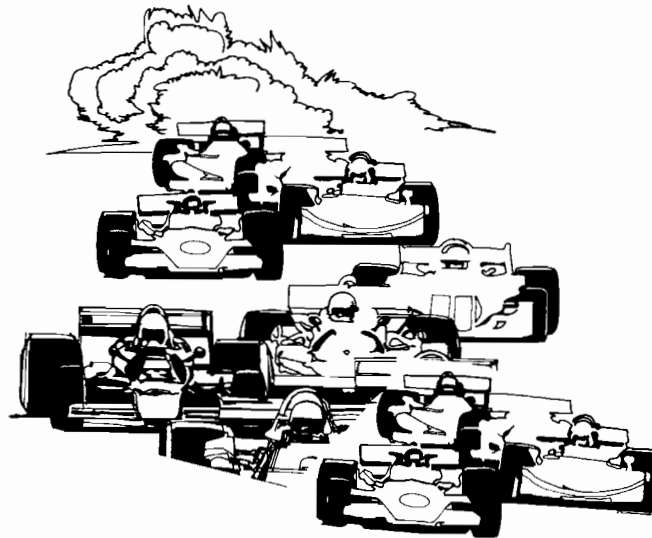

YOUR COMMENTS, PLEASE!

Your comments will assist Atari in improving our publications. The comments are an important part of preparing for revisions of game manuals. Please write in the space below. No postage stamp is necessary if mailed in the U.S.A.

If you have any technical questions about certain ATARI games products, or are requesting additional publications, we will immediately forward your note to the appropriate person.

Page: Comments:

Fill in if you wish a reply:

Name _____

Firm _____

Address _____

City _____ State _____ Zip _____

Area Code _____ Phone _____

Distributor

Operator

Other _____

First fold



No Postage
Necessary
if mailed in
the United States

BUSINESS REPLY MAIL

FIRST CLASS

PERMIT NO. 1004

SUNNYVALE, CA

POSTAGE WILL BE PAID BY ADDRESSEE

Atari, Inc.
Attn: Field Service/Coin-Op Division
P.O. Box 906
737 Sycamore
Milpitas, California 95035

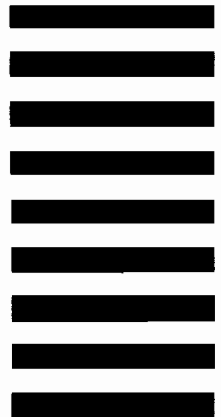

Second fold

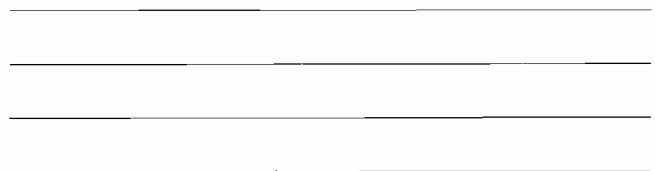

Tape this edge

From:

YOUR COMMENTS, PLEASE!

Your comments will assist Atari in improving our publications. The comments are an important part of preparing for revisions of game manuals. Please write in the space below.

If you have any technical questions about certain ATARI games products, or are requesting additional publications, we will immediately forward your note to the appropriate person.

Page: Comments:

Fill in if you wish a reply:

Name _____

Firm _____

Address _____

City _____ Country _____

Phone: Country Code _____ Local Number _____

Distributor

Operator

Other _____

First fold

Attach
Necessary
Postage

**Atari Ireland Limited
Attn: Field Service/Coin-Op Division
Tipperary Town, Ireland**

Second fold

From:

Tape this edge



Kit Warranty

Seller warrants that its electronic parts supplied in this kit are free from defects in material and workmanship under normal use and service for a period of ninety (90) days from date of shipment. None of the Seller's other products or parts thereof are warranted.

If the electronic parts supplied in this kit fail to conform to this warranty, Seller's sole liability shall be, at its option, to repair, replace, or credit Buyer's account for such electronic parts which are returned to Seller during said warranty period, provided:

- (a) Seller is promptly notified in writing upon discovery by Buyer that said products are defective;
- (b) Such products are returned prepaid to Seller's plant; and
- (c) Seller's examination of said products discloses to Seller's satisfaction that such alleged defects existed and were not caused by accident, misuse, neglect, alteration, improper repair, installation, or improper testing.

In no event shall Seller be liable for loss of profits, loss of use, incidental or consequential damages.

Except for any express warranty set forth in a written contract between Seller and Buyer which contract supersedes the terms herein, this warranty is expressed in lieu of all other warranties expressed or implied, including the implied warranties of merchantability and fitness for a particular purpose, and of all other obligations or liabilities on the Seller's part, and it neither assumes nor authorizes any other person to assume for the Seller any other liabilities in connection with the sale of products by Seller.

The use of any non-Atari parts may void your warranty, according to the terms of the warranty. The use of any non-Atari parts may also adversely affect the safety of your game and cause injury to you and others. Be very cautious in using non-Atari-supplied components with our games, in order to ensure your safety.

Atari distributors are independent, being privately owned and operated. In their judgment they may sell parts or accessories other than Atari parts or accessories. Atari cannot be responsible for the quality, suitability or safety of any non-Atari part or any modification including labor which is performed by such distributor.

Game Warranty

Seller warrants that its printed-circuit boards and parts thereon are free from defects in material and workmanship under normal use and service for a period of ninety (90) days from date of shipment. Seller warrants that its video displays (in games supplied with displays) are free from defects in material and workmanship under normal use and service for a period of thirty (30) days from date of shipment. None of the Seller's other products or parts thereof are warranted.

If the products described in this manual fail to conform to this warranty, Seller's sole liability shall be, at its option, to repair, replace, or credit Buyer's account for such products which are returned to Seller during said warranty period, provided:

- (a) Seller is promptly notified in writing upon discovery by Buyer that said products are defective;
- (b) Such products are returned prepaid to Seller's plant; and
- (c) Seller's examination of said products discloses to Seller's satisfaction that such alleged defects existed and were not caused by accident, misuse, neglect, alteration, improper repair, installation, or improper testing.

In no event shall Seller be liable for loss of profits, loss of use, incidental or consequential damages.

Except for any express warranty set forth in a written contract between Seller and Buyer which contract supersedes the terms herein, this warranty is expressed in lieu of all other warranties expressed or implied, including the implied warranties of merchantability and fitness for a particular purpose, and of all other obligations or liabilities on the Seller's part, and it neither assumes nor authorizes any other person to assume for the Seller any other liabilities in connection with the sale of products by Seller.

The use of any non-Atari parts may void your warranty, according to the terms of the warranty. The use of any non-Atari parts may also adversely affect the safety of your game and cause injury to you and others. Be very cautious in using non-Atari-supplied components with our games, in order to insure your safety.

Atari distributors are independent, being privately owned and operated. In their judgment they may sell parts or accessories other than Atari parts or accessories. Atari cannot be responsible for the quality, suitability or safety of any non-Atari part or any modification including labor which is performed by such distributor.

